



WTB4FP-213111A0ZZZ

W4

MINIATURE PHOTOELECTRIC SENSORS

SICK
Sensor Intelligence.



Illustration may differ

Ordering information

Type	Part no.
WTB4FP-213111A0ZZZ	1131185

Other models and accessories → www.sick.com/W4



Detailed technical data

Features

Functional principle	Photoelectric proximity sensor
Functional principle detail	Background suppression, MultiPulse
Sensing range	
Sensing range min.	30 mm
Sensing range max.	150 mm
Reference object	Object with 90% remission factor (complies with standard white according to DIN 5033)
Minimum distance between set sensing range and background (black 6% / white 90%)	30 mm, at a distance of 150 mm
Emitted beam	
Light source	PinPoint LED
Type of light	Visible red light
Shape of light spot	Point-shaped
Light spot size (distance)	Ø 4.2 mm (130 mm)
Maximum dispersion of the emitted beam around the standardized transmission axis (squint angle)	< +/- 1.5° (at T _a = +23 °C)
Key LED figures	
Normative reference	EN 62471:2008-09 IEC 62471:2006, modified
LED risk group marking	Free group
Wave length	635 nm
Average service life	100,000 h at T _a = +25 °C

Smallest detectable object (MDO) typ.	0.2 mm (At 130 mm distance (object with 90% remission (complies with standard white according to DIN 5033)))	
Adjustment	None	-
Indication	LED green	Operating indicator Static on: power on
	LED yellow	Status of received light beam Oscillating: object present Static off: object not present
Special features	MultiPulse: sensor with self-monitoring Fixed sensing range 30 ... 150 mm	

Safety-related parameters

MTTF_D	663 years
DC_{avg}	0 %
T_M (mission time)	20 years (EN ISO 13849, rate of use: 60 %)

Electrical data

Supply voltage U_B	10 V DC ... 30 V DC ¹⁾	
Ripple	≤ 5 V _{pp}	
Usage category	DC-12 (According to EN 60947-5-2) DC-13 (According to EN 60947-5-2)	
Current consumption	≤ 25 mA, without load. At U _B = 24 V	
Protection class	III	
Digital output	Number	1
	Type	Push-pull: PNP/NPN
	Signal voltage PNP HIGH/LOW	Approx. U _B -2.5 V / 0 V
	Signal voltage NPN HIGH/LOW	Approx. U _B / < 2.5 V
	Output current I _{max.}	≤ 100 mA
	Circuit protection outputs	Reverse polarity protected Overcurrent protected Short-circuit protected
	Response time	≤ 0.1 s ²⁾
	Repeatability (response time)	150 μs
	Switching frequency	10 Hz ³⁾
Pin/Wire assignment	Function of pin 4/black (BK)	Digital output, object present → output Q, HIGH/LOW oscillating 10 Hz ⁴⁾

¹⁾ Limit values.

²⁾ Signal transit time with resistive load in switching mode.

³⁾ With light/dark ratio 1:1.

⁴⁾ This switching output must not be connected to another output.

Mechanical data

Housing	Rectangular
----------------	-------------

Design detail	Flat
Dimensions (W x H x D)	16 mm x 40.1 mm x 12.1 mm
Connection	Connector M8, 3-pin
Material	
Housing	Plastic, VISTAL®
Front screen	Plastic, PMMA
Male connector	Plastic, VISTAL®
Weight	Approx. 30 g
Maximum tightening torque of the fixing screws	0.4 Nm

Ambient data

Enclosure rating	IP66 (EN 60529) IP67 (EN 60529)
Ambient operating temperature	-40 °C ... +60 °C
Ambient temperature, storage	-40 °C ... +75 °C
Typ. Ambient light immunity	Artificial light: ≤ 50,000 lx Sunlight: ≤ 50,000 lx
Shock resistance	30 g, 11 ms (3 positive and 3 negative shocks along X, Y, Z axes, 18 total shocks (EN60068-2-27))
Vibration resistance	10 Hz ... 1,000 Hz (Amplitude 1 mm, 3 x 30 min (EN60068-2-6))
Air humidity	35 % ... 95 %, Relative humidity (no condensation)
Electromagnetic compatibility (EMC)	EN 60947-5-2
Resistance to cleaning agent	ECOLAB
UL File No.	NRKH.E181493 & NRKH7.E181493

Classifications

ECLASS 5.0	27270904
ECLASS 5.1.4	27270904
ECLASS 6.0	27270904
ECLASS 6.2	27270904
ECLASS 7.0	27270904
ECLASS 8.0	27270904
ECLASS 8.1	27270904
ECLASS 9.0	27270904
ECLASS 10.0	27270904
ECLASS 11.0	27270904
ECLASS 12.0	27270903
ETIM 5.0	EC002719
ETIM 6.0	EC002719
ETIM 7.0	EC002719
ETIM 8.0	EC002719
UNSPSC 16.0901	39121528

Adjustments

Display and adjustment elements

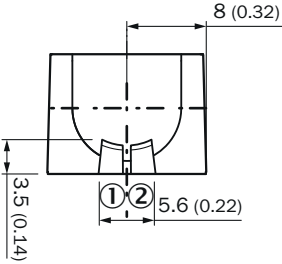

- ① LED green
- ② LED yellow

Connection type

Connector M8, 3-pin

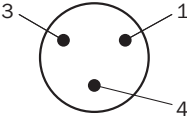

Connection diagram

Cd-522

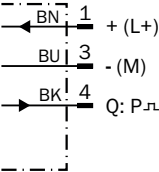

Characteristic curve

Minimum distance in mm (y) between the set sensing range and white background (90 % remission)

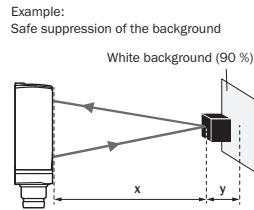
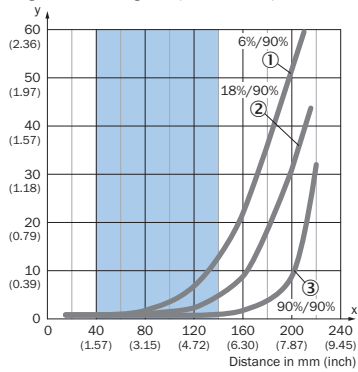

Black object (6 % remission)
 Set sensing range $x = 120$ mm
 Needed minimum distance to white background $y = 7$ mm

Recommended sensing range for the best performance

- ① Black object, 6% remission factor
- ② Gray object, 18% remission factor
- ③ White object, 90% remission factor

Light spot size

Dimensions in mm (inch)

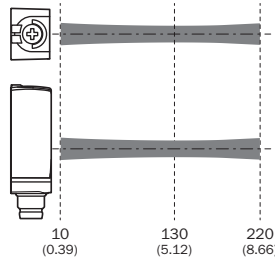
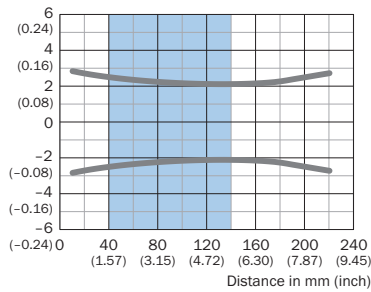

Recommended sensing range for the best performance

Sensing range diagram

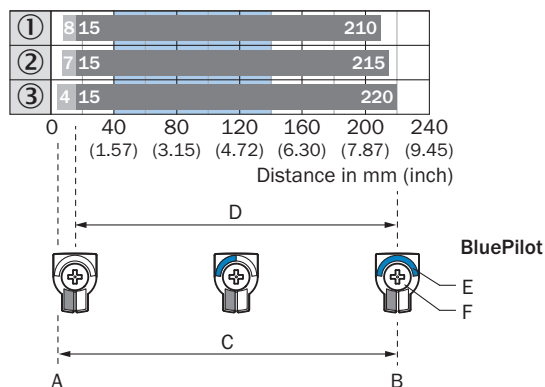

- A = Sensing range min. in mm
- B = Sensing range max. in mm
- C = Viewing range
- D = Adjustable switching threshold for background suppression
- E = Sensing range indicator
- F = Teach-Turn adjustment

■ Recommended sensing range for the best performance

- ① Black object, 6% remission factor
- ② Gray object, 18% remission factor
- ③ White object, 90% remission factor

Functional principle

Functional principle: switching status

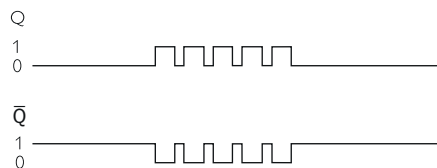
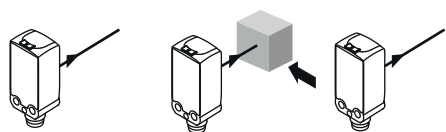

Dimensional drawing (Dimensions in mm (inch))

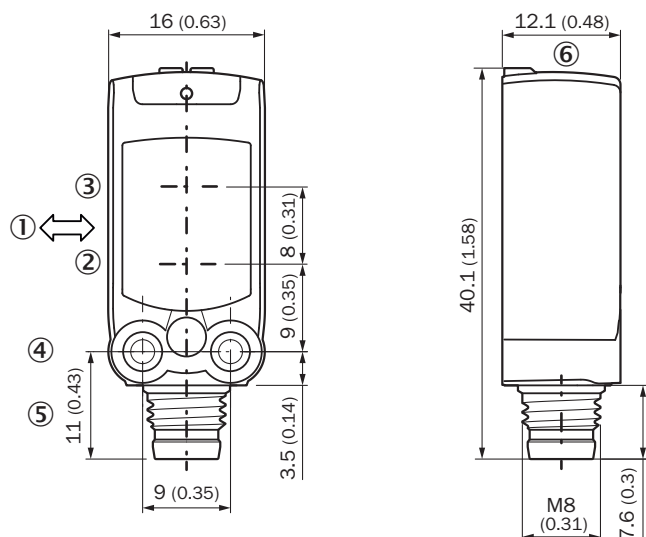

- ① Standard direction of the material being detected
- ② Center of optical axis, sender
- ③ Center of optical axis, receiver
- ④ M3 mounting hole
- ⑤ Connection
- ⑥ Display and adjustment elements

Recommended accessories

Other models and accessories → www.sick.com/W4

	Brief description	Type	Part no.
Mounting brackets and plates			
	Mounting bracket for wall mounting, Stainless steel 1.4571, mounting hardware included	BEF-W4-A	2051628

SICK AT A GLANCE

SICK is one of the leading manufacturers of intelligent sensors and sensor solutions for industrial applications. A unique range of products and services creates the perfect basis for controlling processes securely and efficiently, protecting individuals from accidents and preventing damage to the environment.

We have extensive experience in a wide range of industries and understand their processes and requirements. With intelligent sensors, we can deliver exactly what our customers need. In application centers in Europe, Asia and North America, system solutions are tested and optimized in accordance with customer specifications. All this makes us a reliable supplier and development partner.

Comprehensive services complete our offering: SICK LifeTime Services provide support throughout the machine life cycle and ensure safety and productivity.

For us, that is “Sensor Intelligence.”

WORLDWIDE PRESENCE:

Contacts and other locations –www.sick.com