

## StructuredGround™ Direct Burial Compression Grounding System

The Panduit® StructuredGround™ Direct Burial Compression Grounding System provides the **highest performance and most reliable compression connection in the industry**. This system offers the speed and safety of a compression connection, while complying with the industry requirements of IEEE Std. 837. The fully inspectable system that is UL 467 Listed and CSA 22.2 Certified, ensures that the installed product operates safely. Wide range-taking and universal designs provide installation flexibility with a minimum number of parts, reducing procurement and inventory costs. Innovative features assure a high quality bond, reducing labor costs and improving crimp quality.

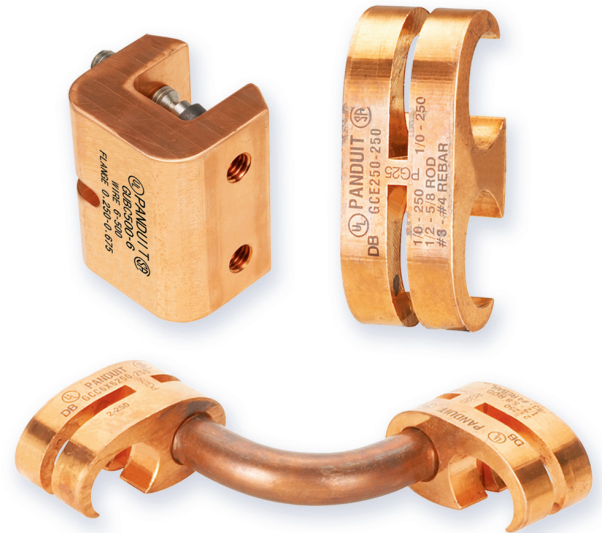

### Key Features

### Benefits

<b>Meets IEEE Std 837</b>	Offers the speed and safety of a compression connection through patented crimp technology for maximum reliability. Compliant to IEEE837, Rev 2002 and 2014.
<b>Exceeds UL 467 and CSA 22.2 with Panduit or industry standard crimping tools and Panduit crimping dies</b>	Standards compliance and full inspectability ensures that the installed product operates safely, while reducing installation tool costs and providing convenience
<b>Complies with MIL-STD-202G (METHOD 201A)</b>	Reliable performance in high vibration environments
<b>Compression connection</b>	Non-flammable process that installs quickly and safely in any weather condition
<b>Wide range-taking ability and multi-conductor designs</b>	Provide design and installation flexibility with a minimum number of parts, reduce procurement costs, ease inventory management, and improve availability to meet critical project schedules
<b>Pre-applied conductive antioxidant compound</b>	Ensures a high quality mechanical and electrical bond, speeding installation
<b>Slotted tap design and locator die</b>	Speeds installation time, reduces labor costs and improves crimp quality

### Applications



Oil and Gas



Industrial Facilities



Cell Towers



Construction

# StructuredGround™ Direct Burial Compression Grounding System

## Meets the most stringent industry standards while offering unmatched ease of installation and safety.

### Why Does This Matter?

Grounding is a critical functioning part of the electrical system. The integrity of your grounding system is dependent upon your connectors withstanding the environment in which they are installed. Achieving this reliability, while maximizing safety and speeding installation ensures a grounding system that will provide you with the greatest value.

With the StructuredGround™ Direct Burial Compression Grounding System, you benefit from a connector that meets the highest performance specification in the industry, faster installation, ensured safety in any weather condition, with a minimum investment in tooling and inventory.

## Tested to IEEE 837, Rev 2002 and 2014



The IEEE Green Book, “IEEE Recommended Practice for Grounding of Industrial and Commercial Power Systems (IEEE Std 142-2007)”, states: “(i)t is recommended that [grounding] connections meet the requirements of IEEE Std 837.” The purpose of the “IEEE Std 837 for Qualifying Permanent Connections used in Substation Grounding” standard is to give assurance to the user that a connection meeting the requirements of this standard will perform in a satisfactory manner over the lifetime of the installation.

IEEE Std 837 goes beyond the testing required by UL 467 and CSA 22.2, requiring sequences of environmental simulations including: lightning strike, freeze-thaw cycling, and chemical corrosion, to provide better assurance that the grounding system will remain viable throughout its installed life.

Panduit’s enhanced crimp process, using patented technology, achieves the latest performance requirements and continues to provide unmatched verification of corrosion resistance. See page 8.

## Reduces Installation Costs



- Can be installed in any weather – from extreme cold to wet conditions – the StructuredGround™ Direct Burial Compression Grounding System will keep your construction project on time and on budget
- Wide range-taking components can go from #6 to 500 kcmil wire with only five parts in the GCE and GCC families, minimizing inventory and tool investment
- Only a single die required to crimp each element
- Full inspectability – die index numbers are embossed on the connector body during the crimp process allowing the inspector to quickly and easily identify a proper installation

## Increases Job-Site Safety



- No weld connections – special protective equipment or extra clothing is not required
- Full inspectability – die index numbers are embossed on the connector body during the crimp process allowing the inspector to quickly and easily identify a proper installation
- Hydraulic and battery operated compression connection crimping tools reduce operator stress and fatigue



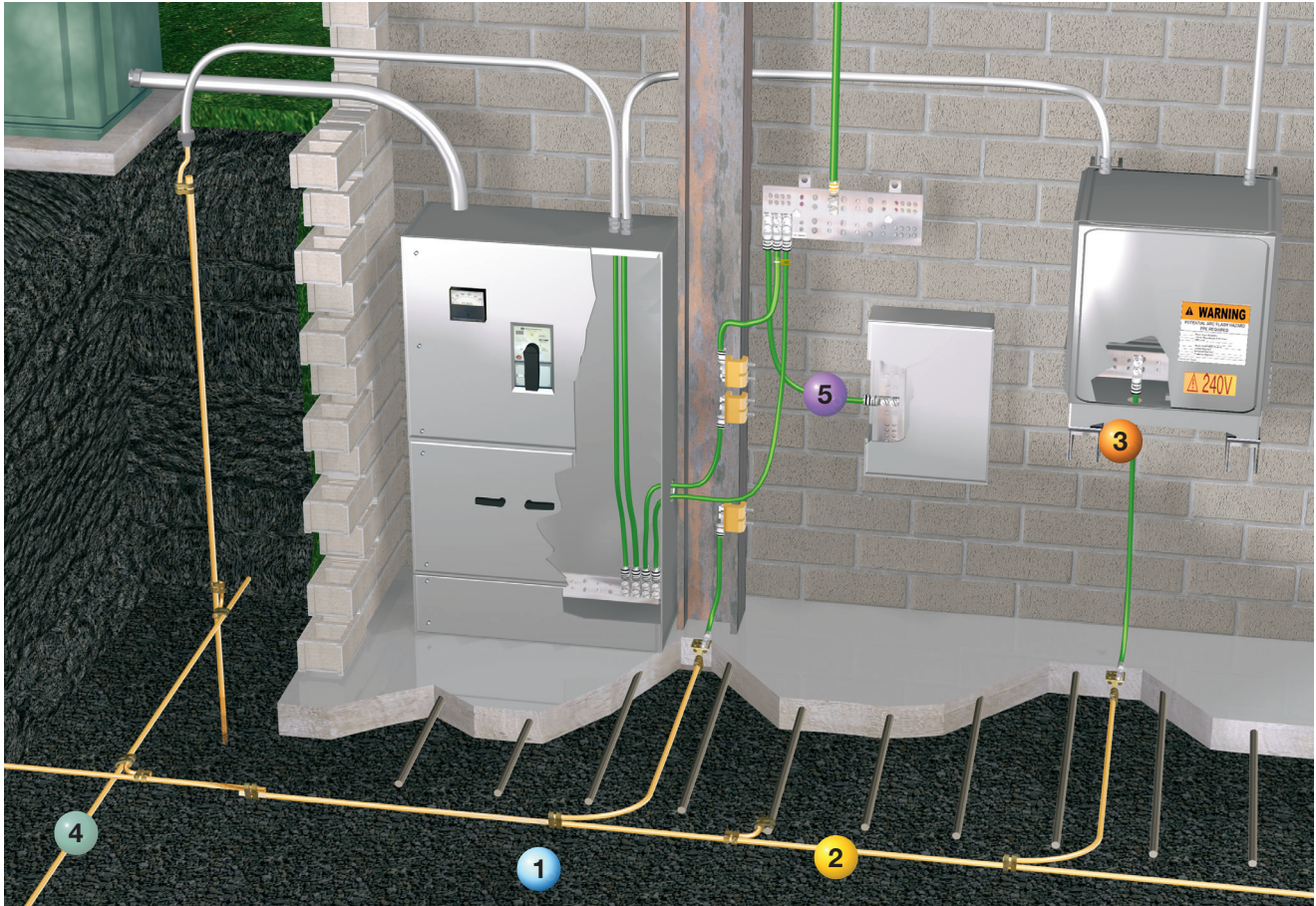

**1 Conductor to Conductor**



E Style and Cross Connectors: Creates bonds between parallel grounding conductors.  
See pages 4 & 5

**2 Conductor to Rebar**



E Style and Cross Connectors: Allows bonds to reinforcing bars.  
See pages 4 & 5

**3 Related Product LCC-W**



Long Barrel Two-Hole Code Conductor Lugs: For use with stranded copper conductors.  
Visit [www.panduit.com](http://www.panduit.com) for complete part details.

**4 Conductor to Ground Rod**

E Style and Cross Connectors: Creates bonds between perpendicular grounding conductors.  
See pages 4 & 5



**5 Conductor to Building Steel**

Universal Beam Grounding Clamp: Bonds structural steel to grounding conductor system.  
See page 6



AC equipment should be grounded per NEC standards.  
Enclosures should be grounded per manufacturer's specifications.

# StructuredGround™ Direct Burial Compression Grounding System

## E Style Grounding Connectors



- Wide range-taking ability and multi-conductor design provide flexibility with a minimum number of parts, allowing for conductor to conductor, conductor to rebar, and conductor to ground rod applications
- Designed for the enhanced crimp process using patented technology which meets IEEE Std 837
- Slotted design allows quick and easy assembly of conductor to connector using Panduit cable ties, included
- Patented pre-applied conductive antioxidant compound ensures a high quality mechanical and electrical bond, speeding installation
- Color-coded and marked with Panduit die index numbers for proper crimp die selection
- UL 467 Listed and CSA 22.2 Certified for grounding and bonding suitable for direct burial in earth or concrete when crimped with Panduit or industry standard crimping tools and Panduit dies
- Complies with vibration tests per MIL-STD-202G (METHOD 201A)



Views using cable ties

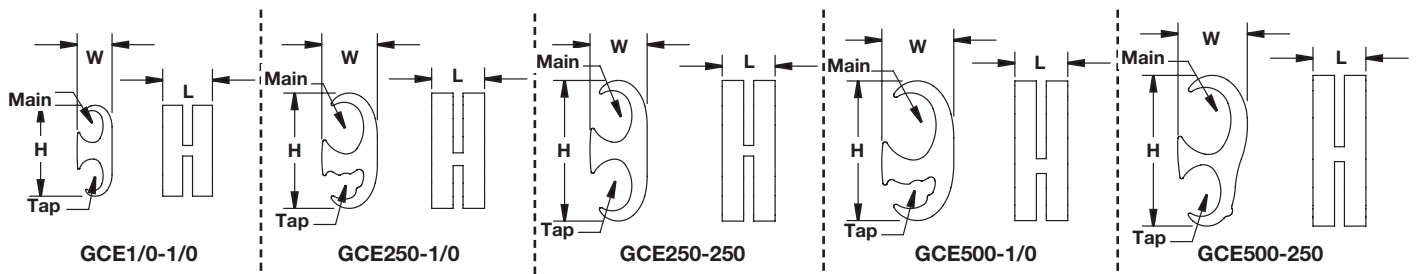
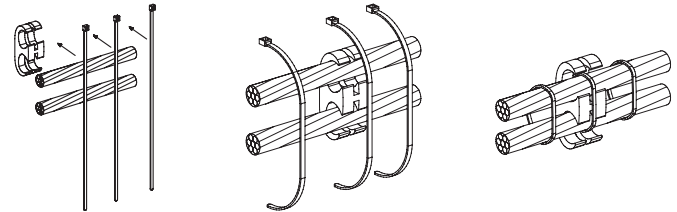

Part Number	Element	Copper Conductor Size Range AWG (mm <sup>2</sup> )	Ground Rod Size In. (mm)	Rebar Size In. (mm)	Figure Dimensions In. (mm)			Panduit Color Code	Panduit Die Index No.	Std. Pkg. Qty.	Crimp Process*	
					L	W	H				UL Listed and CSA Certified	IEEE Std 837
GCE1/0-1/0	Main	#6 SOL - 1/0 STR (16 - 50)	-	-	0.94 (23.9)	0.66 (16.8)	1.72 (43.7)	Red	PG10	1	Traditional	Traditional
	Tap											
GCE250-1/0	Main	1/0 STR - 250 kcmil (70 - 120)	1/2 - 5/8 (12.7 - 15.9)	3/8 - 1/2, #3 - #4 (9.5 - 12.7), (#10 - #13)	1.00 (25.4)	1.06 (26.9)	2.18 (55.4)	Black	PG25	1	Traditional	Enhanced
	Tap											
GCE250-250	Main	1/0 STR - 250 kcmil (70 - 120)	1/2 - 5/8 (12.7 - 15.9)	3/8 - 1/2, #3 - #4 (9.5 - 12.7), (#10 - #13)	1.00 (25.4)	1.08 (27.4)	2.66 (67.6)	Black	PG25	1	Traditional	Enhanced
	Tap											
GCE500-1/0	Main	250 - 500 kcmil (150 - 240)	1/2 - 3/4 (12.7 - 19.1)	5/8 - 3/4, #5 - #6 (15.9 - 19.1), (#16 - #19)	1.00 (25.4)	1.36 (34.5)	2.64 (67.1)	Blue	PG50	1	Traditional	Enhanced
	Tap											
GCE500-250	Main	250 - 500 kcmil (150 - 240)	1/2 - 3/4 (12.7 - 19.1)	5/8 - 3/4, #5 - #6 (15.9 - 19.1), (#16 - #19)	1.00 (25.4)	1.32 (33.4)	2.85 (72.4)	Blue	PG50	1	Traditional	Enhanced
	Tap											

\*See page 8 for crimp process details.  
See page 7 for a complete list of installation tooling and die selections.

# Grounding Cross Connectors



- Only a single die required to crimp each element, which speeds installation and reduces costs
- Wide range-taking ability and multi-conductor design provide flexibility with a minimum number of parts, allowing for conductor to conductor, conductor to rebar, and conductor to ground rod applications
- Designed for the enhanced crimp process using patented technology which meets IEEE Std 837
- Slotted design allows quick and easy assembly of conductor to connector using Panduit cable ties, included
- Patented pre-applied conductive antioxidant compound ensures a high quality mechanical and electrical bond, speeding installation
- Color-coded and marked with Panduit die index numbers for proper crimp die selection
- UL 467 Listed and CSA 22.2 Certified for grounding and bonding suitable for direct burial in earth or concrete when crimped with Panduit or industry standard crimping tools and Panduit dies
- Complies with vibration tests per MIL-STD-202G (METHOD 201A)

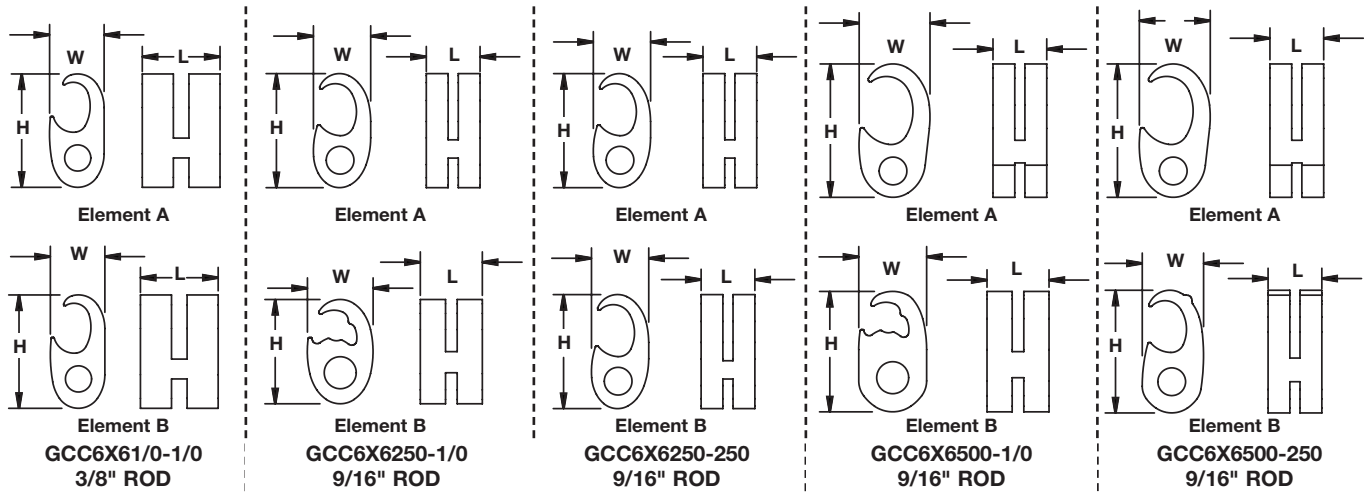

Part Number	Element	Copper Conductor Size Range AWG (mm <sup>2</sup> )	Ground Rod Size In. (mm)	Rebar Size In. (mm)	Figure Dimensions In. (mm)			Panduit Color Code	Panduit Die Index No.	Std. Pkg. Qty.	Crimp Process*	
					L	W	H				UL Listed and CSA Certified	IEEE Std 837
GCC6X6250-1/0	A	#2 SOL - 250 kcmil (35 - 120)	1/2 - 5/8 (12.7 - 15.9)	3/8 - 1/2, #3 - #4 (9.5 - 12.7), (#10 - #13)	1.00 (25.4)	1.06 (26.9)	2.12 (53.8)	Black	PG25	1	Traditional	Enhanced
	B	#6 SOL - 1/0 STR (16 - 50)	—	—	—	—	1.68 (42.7)					
GCC6X6250-250	A	#2 SOL - 250 kcmil (35 - 120)	1/2 - 5/8 (12.7 - 15.9)	3/8 - 1/2, #3 - #4 (9.5 - 12.7), (#10 - #13)	1.00 (25.4)	1.06 (26.9)	2.12 (53.8)	Black	PG25	1	Traditional	Enhanced
	B	#2 SOL - 250 kcmil (35 - 120)	—	—	—	—	—					
GCC6X6500-250	A	250 - 500 kcmil (150 - 240)	1/2 - 3/4 (12.7 - 19.1)	5/8 - 3/4, #5 - #6 (15.9 - 19.1), (#16 - #19)	1.00 (25.4)	1.32 (33.5)	2.48 (63.0)	Blue	PG50	1	Traditional	Enhanced
	B	#2 SOL - 250 kcmil (35 - 120)	—	—	—	—	1.16 (29.5)					

\*See page 8 for crimp process details.  
See page 7 for a complete list of installation tooling and die selections.



# StructuredGround™ Direct Burial Compression Grounding System

## Universal Beam Grounding Clamp

**PATENTED**



**IEEE**



**LISTED CERTIFIED**

**DB RATED**

- Universal, fits on a wide range of standard (angled) and wide flange (parallel) structural steel beams
- Provides a mounting pad suitable for a two-hole compression lug

- Installs quickly and easily with standard 1/4 inch key hex wrench tooling
- UL 467 Listed and CSA 22.2 Certified for grounding and bonding suitable for direct burial in earth or concrete
- Complies with vibration tests per MIL-STD-202G (METHOD 201A)

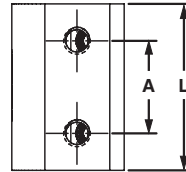
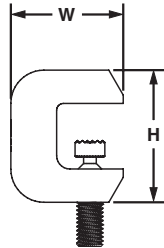
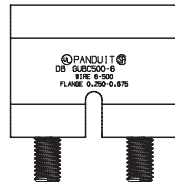

Part Number	Copper Conductor Size Range AWG (mm <sup>2</sup> )	Flange Thickness In. (mm)	Thread Size In.	Figure Dimensions In. (mm)				Std. Pkg. Qty.
				A	L	W	H	
<b>GUBC500-6</b>	#6 AWG – 500 kcmil (16 – 240)	0.250 – 0.675 (6.3 – 17.1)	1/2 – 13	1.75 (44.4)	3.15 (80.0)	2.13 (54.0)	2.50 (63.5)	1

For stainless steel mounting hardware kit, order part number GLMHK (includes two hex head bolts, two split lock washers and two SAE flat washers). For UL467 direct burial lugs, see page 9.

## Locator Dies

**PATENTED**

- Locating rib feature positions tap, ensuring full-width crimp
- Color-coded for easy matching to color coding marked on connectors
- Embosses die index number on connector barrels for post crimp inspection
- Part number permanently marked on crimp die for easy identification
- Provides circumferential crimp resulting in terminations with premium electrical and mechanical performance



Part Number	Used to Install Panduit Tap Part Numbers		Std. Pkg. Qty.
	Copper Tap	Copper Die Color and No.	
<b>CD-930G-1/0</b>	GCE1/0-1/0, GCC6X61/0-1/0	Red PG10	1
<b>CD-930G-250</b>	GCE250-1/0, GCE250-250, GCC6X6250-1/0, GCC6X6250-250	Black PG25	1
<b>CD-930G-500</b>	GCE500-1/0, GCE500-250, GCC6X6500-250	Blue PG50	1

\*See page 8 for crimp process details. See page 7 for a complete list of installation tooling and die selections.

# Installation Tooling and Die Selections for types GCE, GCHE, GCC, GPC connectors

## How to read this chart

For GCE250-1/0 and CT-2930 tool:

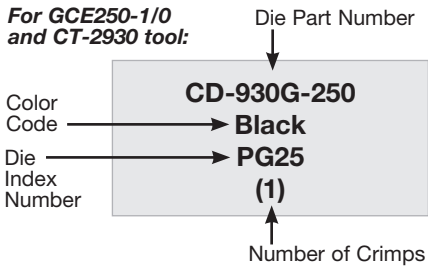

Panduit			Thomas & Betts		Burndy	
12 TON	14 TON	15 TON	14 TON	15 TON	12 TON	15 TON
<b>A</b> See Tool List Below	CT-930 CT-930CH CT-2930 CT-2930/L CT-2930/LE	<b>B</b> See Tool List Below	TBM14M, TBM14MC, 13100A, TBM14RH, TBM14BSCR, BPLT14BSCRI	TBM15 TBM15BSCR	Y750, Y750-2, Y750BH, Y750BH-2, BAT750-14V, PAT750-18V, PAT750C-18V, PAT750XT-18V, PAT750CXT-18V, LPHY750	Y46, Y46C, LPHY46

Part Number	Element	Copper Conductor Size Range	Ground Rod Size In.	Rebar Size In.	Panduit Crimp Die Part Number / Color Code / Die Index Number / (Number of Crimps)		
GCE1/0-1/0	Main	#6 AWG SOL - 1/0 AWG STR	-	-	CD-930G-1/0 Red PG10 (1)	CD-930G-1/0 Red PG10 (1)	CD-930G-1/0 Red PG10 (1)
	Tap	#6 AWG SOL - 1/0 AWG STR	-	-			
GCC6X61/0-1/0	A	#6 AWG SOL - 1/0 AWG STR	-	-	CD-930G-1/0 Red PG10 (1)	CD-930G-1/0 Red PG10 (1)	CD-930G-1/0 Red PG10 (1)
	B	#6 AWG SOL - 1/0 AWG STR	-	-			
GCE250-1/0	Main	1/0 AWG SOL - 250 kcmil	1/2 - 5/8	3/8 - 1/2, #3 - #4	CD-930G-250 Black PG25 (1)	CD-930G-250 Black PG25 (1)	CD-930G-250 Black PG25 (1)
	Tap	#6 AWG SOL - 1/0 AWG STR	-	-			
GCC6X6250-1/0	A	#2 AWG SOL - 250 kcmil	1/2 - 5/8	3/8 - 1/2, #3 - #4	CD-930G-250 Black PG25 (1)	CD-930G-250 Black PG25 (1)	CD-930G-250 Black PG25 (1)
	B	#6 AWG SOL - 1/0 AWG STR	-	-			
GCE250-250 GCHE250-250**	Main	1/0 AWG SOL - 250 kcmil	1/2 - 5/8	3/8 - 1/2, #3 - #4	CD-930G-250 Black PG25 (1)	CD-930G-250 Black PG25 (1)	CD-930G-250 Black PG25 (1)
	Tap	1/0 AWG SOL - 250 kcmil	1/2 - 5/8	3/8 - 1/2, #3 - #4			
GCC6X6250-250	A	#2 AWG SOL - 250 kcmil	1/2 - 5/8	3/8 - 1/2, #3 - #4	CD-930G-250 Black PG25 (1)	CD-930G-250 Black PG25 (1)	CD-930G-250 Black PG25 (1)
	B	#2 AWG SOL - 250 kcmil	1/2 - 5/8	3/8 - 1/2, #3 - #4			
GPC4H250-2		#2 AWG SOL - 250 kcmil	-	-	CD-930G-500 Blue PG50 (1)	CD-930G-500 Blue PG50 (1)	CD-930G-500 Blue PG50 (1)
GCE500-1/0	Main	250 - 500 kcmil	1/2 - 3/4	5/8 - 3/4, #5 - #6			
	Tap	#6 AWG SOL - 1/0 AWG STR	-	-			
GCC6X6500-1/0	A	250 - 500 kcmil	1/2 - 3/4	5/8 - 3/4, #5 - #6	CD-930G-500 Blue PG50 (1)	CD-930G-500 Blue PG50 (1)	CD-930G-500 Blue PG50 (1)
	B	#6 AWG SOL - 1/0 AWG STR	-	-			
GCE500-250 GCHE500-250**	Main	250 - 500 kcmil	1/2 - 3/4	5/8 - 3/4, #5 - #6	CD-930G-500 Blue PG50 (1)	CD-930G-500 Blue PG50 (1)	CD-930G-500 Blue PG50 (1)
	Tap	1/0 AWG SOL - 250 kcmil	-	-			
GCC6X6500-250	A	250 - 500 kcmil	1/2 - 3/4	5/8 - 3/4, #5 - #6	CD-930G-500 Blue PG50 (1)	CD-930G-500 Blue PG50 (1)	CD-930G-500 Blue PG50 (1)
	B	#2 AWG SOL - 250 kcmil	-	-			
*GCE500-500	Main	4/0 STR - 500 kcmil	5/8 - 3/4	5/8 - 3/4, #5 - #6	CD-940G-500 Yellow PG55	CD-940G-500 Yellow PG55	CD-940G-500 Yellow PG55
	Tap	4/0 STR - 500 kcmil	-	-			

Ⓜ15 ton tools require the die adapter when used with CD-930G and CD-940G series crimping dies. Panduit crimping dies must be used with all tooling (Panduit and competitor).

**A** CT-920, CT-920/CV, CT-920CH, CT-920CH/CV, CT-920CH/OCP, CT-2920, ⓂCT-2920/CCP, ⓂCT-2920/CCPINT, ⓂCT-2920/CCPUK, ⓂCT-2920/CCPAUS, ⓂCT-2920/CCPTO, ⓂCT-2920/CCPBT, CT-2931, CT-2931/ST, CT-2931/STINT, CT-2931/STUK, CT-2931/STAUS, CT-2931/TO, CT-2931/STBT, CT-2931/STCV, CT-2931/STCVINT, CT-2931/STCVUK, CT-2931/STCVAUS, CT-2931/CVTO.  
**B** CT-940CH/BJO\*, CT-2940, CT-2940/L, CT-2940/LE, CT-2940/STBT

# StructuredGround™ Direct Burial Compression Grounding System

## Traditional Crimp Process\*\*



### STEP 1. Position tap in die and crimp

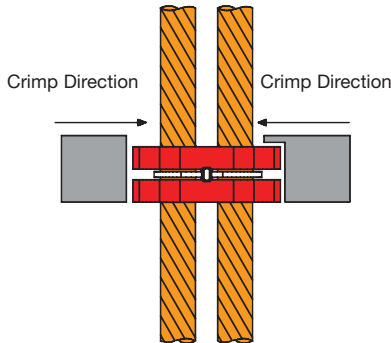

\*\*GCE1/0-1/0 and GCC6X61/0-1/0 achieve IEEE Std 837 through the traditional crimp process.

The traditional crimp process embosses the die number on the part *once*, for full inspectability



## Enhanced Crimp Process – Using Patented Technology



### STEP 1. Position tap in die and crimp

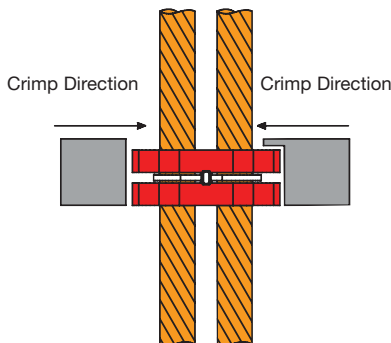

### STEP 3. Reposition crimping tool, position tap in die and crimp

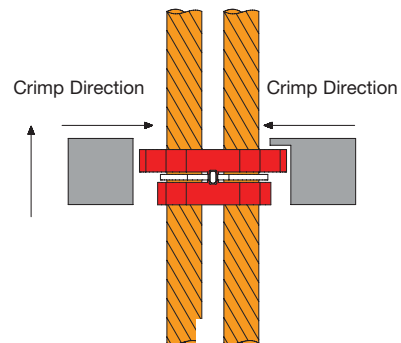

### STEP 2. Reposition crimping tool, identify slotted tap design, align with locator die and crimp

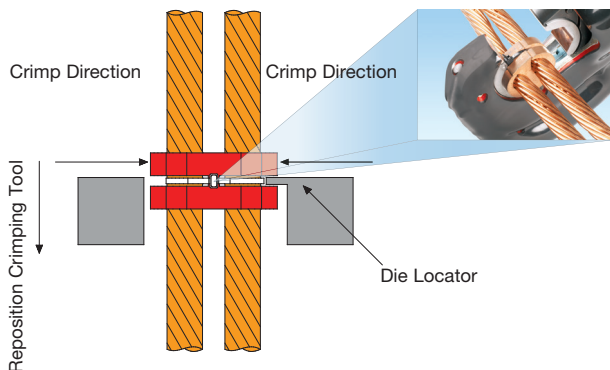

The enhanced crimp process embosses the die number on the part *twice*, for full inspectability





## Direct Burial Grounding Lugs

- For use with Stranded Copper Conductors
- Type LCC – B
- Long barrel maximizes number of crimps and provides premium wire pull-out strength and electrical performance
- Color-coded barrels marked with Panduit and specified competitor die index number for proper crimp die selection
- Enclosed barrel prevents corrosive material from entering barrel when used in harsh environments
- Made of High conductivity copper and Factory pre-applied with conductive antioxidant compound to ensure a high quality electrical bond pre-filled with conductive antioxidant compound to ensure a high quality electrical bond
- cULus 467 Listed for grounding and suitable for direct burial in earth or concrete
- NEMA hole sizes and spacing

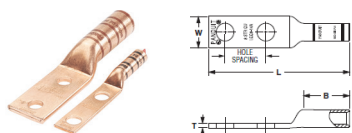

Part Number	Copper Conductor Size	Stud Hole Size (in.)	Stud Hole Spacing (in.)	Figure Dimensions (In.)				Panduit Color Code	Panduit Die Index No.	Bundy Die Index No.	T&B Die Index No.	Wire Strip Length (in.)	Std. Pkg. Qty.
				W	B	T	L						
LCC4/0-12-B-X	4/0 AWG	1/2	1.75	1.06	1.56	0.14	5.13	Purple	P54	15	54	1 5/8	10

For list of Panduit and compatible competitor tool info, reference Type LCC on the Power Connectors Tool and Die Selection Guides found on Panduit.com

## Light-Duty Beam Grounding Clamp

- Universal, fits on a wide range of standard (angled) and wide flange (parallel) structural steel beams
- Installs quickly by means of a single cone point screw, requires a standard 1/4" key hex wrench tool
- Includes metal stays to position a 2-hole NEMA-spaced lug (requires no mounting hardware)
- cULus 467 Listed for grounding and bonding and suitable for direct burial in earth or concrete

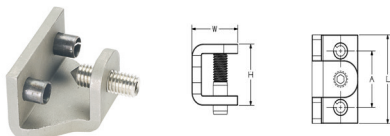

Part Number	Copper Conductor Size Range AWG (mm <sup>2</sup> )	Flange Thickness In. (mm)	Figure Dimensions (In.)				Std. Pkg. Qty.
			A	L	W	H	
GUBC4/0-6	#6 AWG - 4/0 STR (16 - 95)	0.250 - 0.675 (6.3 - 17.1)	1.75 (44.4)	2.75 (69.8)	1.65 (41.9)	1.90 (48.3)	50

### WORLDWIDE SUBSIDIARIES AND SALES OFFICES

PANDUIT CANADA  
Markham, Ontario  
cs-cdn@panduit.com  
Phone: 800.777.3300

PANDUIT EUROPE LTD.  
London, UK  
cs-emea@panduit.com  
Phone: 44.20.8601.7200

PANDUIT SINGAPORE PTE. LTD.  
Republic of Singapore  
cs-ap@panduit.com  
Phone: 65.6305.7575

PANDUIT JAPAN  
Tokyo, Japan  
cs-japan@panduit.com  
Phone: 81.3.6863.6000

PANDUIT LATIN AMERICA  
Guadalajara, Mexico  
cs-la@panduit.com  
Phone: 52.33.3777.6000

PANDUIT AUSTRALIA PTY. LTD.  
Victoria, Australia  
cs-aus@panduit.com  
Phone: 61.3.9794.9020

For a copy of Panduit product warranties, log on to [www.panduit.com/warranty](http://www.panduit.com/warranty)

For more information

Visit us at [www.panduit.com](http://www.panduit.com)

Contact Customer Service by email: [cs@panduit.com](mailto:cs@panduit.com)  
or by phone: 800.777.3300

© 2022 Panduit Corp.  
ALL RIGHTS RESERVED.  
Printed in the U.S.A.  
GRCB9-SA-ENG  
Replaces GRCB06--SA-ENG  
09/2022