

Installation Instructions for PSG120E24RM POWER SUPPLY

**READ INSTRUCTIONS BEFORE INSTALLING OR OPERATING THIS DEVICE.
KEEP FOR FUTURE REFERENCE.**

US: Eaton
W126N7250 Flint Drive
Menomonee Falls, WI 53051
www.eaton.com

EU: Eaton Industries GmbH
Hein-Moeller-Str. 7-11
53115 Bonn, Germany
www.eaton.eu

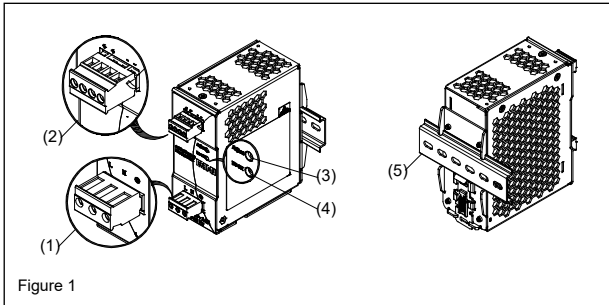

Figure 1

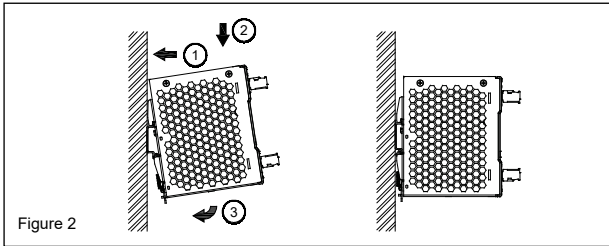

Figure 2

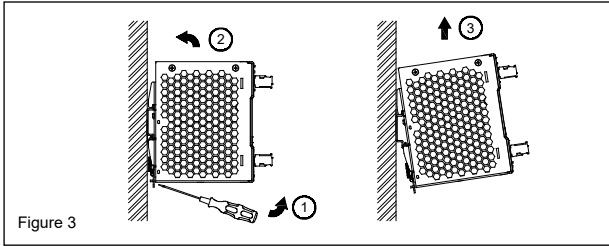

Figure 3

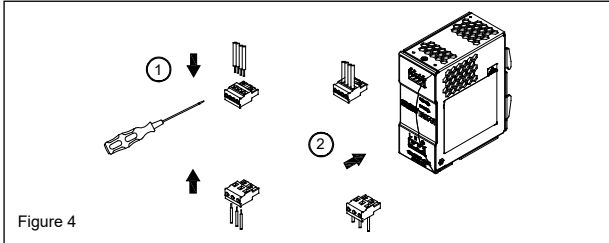

Figure 4

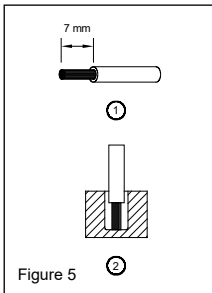

Figure 5

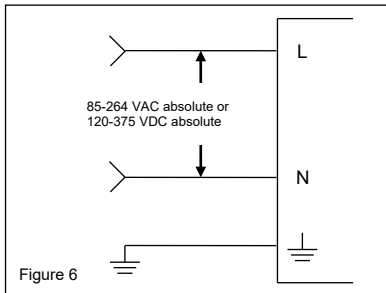

Figure 6

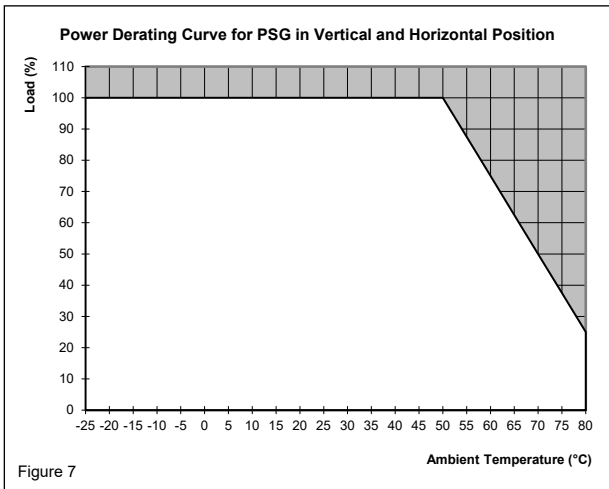

Figure 7

1. Safety instructions

- Switch main power off before connecting or disconnecting the device. Risk of explosion!
 - To guarantee sufficient convection cooling, please keep a distance of 50 mm above and below the device as well as a lateral distance of 20 mm to other units.
 - Note that the enclosure of the device can become very hot depending on the ambient temperature and load of the power supply. Risk of burns!
 - Only plug in and unplug connectors when power is turned off!
 - Do not introduce any objects into the unit!
 - Dangerous voltage present for at least 5 minutes after disconnecting all sources of power.
 - The power supplies are built-in units and must be installed in a cabinet or room (condensation free environment and indoor location) that is relatively free of conductive contaminants.
 - The unit must be installed in an IP54 enclosure or cabinet in the final installation.
 - Warning: Explosion Hazard – Substitution of components may impair suitability for Class 1, Division 2.
 - Warning: Explosion Hazard – Do not disconnect equipment or adjust potentiometer unless the power has been switched off or the area is known to be non-hazardous.
- CAUTION:** "FOR USE IN A CONTROLLED ENVIRONMENT".

2. Device description (Fig. 1)

- (1) Input terminal block connector
- (2) Output terminal block connector
- (3) DC voltage adjustment potentiometer
- (4) DC OK control LED (green)
- (5) Universal mounting rail system

3. Mounting (Fig. 2)

The power supply unit can be mounting on 35 mm DIN rails in accordance with EN 60715. The device should be installed with input terminal block on the bottom.

Each device is delivered ready to install.

Snap on the DIN rail as shown in Fig. 2:

1. Tilt the unit slightly upwards and put it onto the DIN rail.
2. Push downwards until stopped.
3. Press against the bottom front side for locking.
4. Shake the unit slightly to ensure that it is secured.

4. Dismounting (Fig. 3)

To uninstall, pull or slide down the latch as shown in Fig. 3. Then, slide the PSU in the opposite direction, release the latch and pull out the PSU from the rail.

5. Connection

The terminal block connectors allow easy and fast wiring.

You can use flexible (stranded wire) or solid cables with cross section 0.52-3.3 mm² (AWG 20-12) and torque of 4.67 Kgf-cm (4.05 lb in). To secure reliable and shock proof connections, the stripping length should be 7 mm (see Fig. 5 (1)). Please ensure that wires are fully inserted into the connecting terminals as shown in Fig. 5 (2).

Caution: Must tighten wire to housing (Fig. 4 (1)) before plugging into the terminal block connection (Fig. 4 (2)).

In accordance to EN 60950 / UL 60950, flexible cables require ferrules.

Use appropriate copper cables that are designed to sustain operating temperature of 60°C / 75°C or more to fulfill UL requirements.

5.1. Input connection (Fig. 1 (1), Fig. 6)

For AC input connections, use L, N and PE connections of input terminal connector (see Fig. 1 (1)) to establish the 100-240 VAC connection.

For DC input connections, connect L to +V_s and connect N to -V_s.

The unit is protected with internal fuse (not replaceable) at L pin and it has been tested and approved on 20A (UL) and 16A (IEC) branch circuits without additional protection device. An external protection device is only required if the supplying branch has an ampacity greater than above. Thus, if an external protective device is necessary, or, utilized, a minimum value of 10A B- or 6A C- characteristic breaker should be used.

The internal fuse must not be replaced by the user.
In case of internal defect, please call 1 - 877 - ETN - CARE

5.2. Output connection (Fig. 1 (2))

Use the "+" and "-" screw connections to establish the 24 VDC connection. The output provides 24 VDC. The output voltage can be adjusted from 24 to 28 VDC on the potentiometer. The green LED DC OK displays correct function of the output (Fig. 1 (4)). The device has a short circuit and overload protection and an overvoltage protection limited to 35 VDC.

5.3. Output characteristic curve





The device functions normal under operating line and load conditions. In the event of a short circuit or overload the output voltage and current collapses (I_{OVL} or I_{SC} is $>I_{surge}$ (150%)). The secondary voltage is reduced and bounces until short circuit or overload on the secondary side has been removed.

5.4. Thermal behavior (Fig. 7).

In the case of ambient temperatures above +50°C, the output capacity has to be reduced by 2.5% per degree Celsius increase in temperature. If the output capacity is not reduced when T_{Amb} > 50°C, the device will run into thermal protection by switching off i.e. device will go in bouncing mode and will recover when ambient temperature is lowered or load is reduced as far as necessary to keep device in working condition.

FOR TECHNICAL ASSISTANCE CALL 1 - 877 - ETN - CARE

TECHNICAL DATA FOR PSG120E24RM

Input (AC)	
Nominal input voltage / frequency	100-240 VAC / 50-60 Hz
Voltage range	85-264 VAC
Frequency	47-63 Hz
Nominal current	< 2.20 A @ 115 VAC, < 1.10 A @ 230 VAC
Inrush current limitation. I ² t (+25°C) typ.	< 35 A @ 115 VAC & 230 VAC
Mains buffering at nominal load (typ.)	> 20 ms @ 115 VAC, > 115 ms @ 230 VAC
Turn-on time	< 1 sec.
Internal fuse	T 4 AH / 250 V
Leakage current	< 1 mA @ 240 VAC
Output (DC)	
Nominal output voltage U _N / tolerance	24 VDC ± 2 %
Adjustment range of the voltage	24-28 VDC (maximum power ≤ 120 W)
Nominal current	5 A
Derating	> 50°C (2.5 % / °C)
Startup with capacitive loads	Max. 10,000 µF
Max. power dissipation idling / nominal load approx.	14.8 W
Efficiency	> 89.0% @ 115 VAC & 230 VAC
Residual ripple / peak switching (20 MHz) (at nominal values)	< 50 mVpp / < 150 mVpp
Parallel operation	PSG480R24RM / PSG960R24RM / With ORing Diode
General Data	
Type of housing	Aluminum
Signals	Green LED DC OK
MTBF	> 800,000 hrs.
Dimensions (L x W x H)	121 mm x 50 mm x 123 mm
Weight	0.72 kg
Connection method	Screw connection
Stripping length	7 mm
Operating temperature (surrounding air temperature)	-25°C to +80°C (Refer to Fig. 7)
Storage temperature	-25°C to +85°C
Humidity at +25°C, no condensation	< 95% RH
Vibration (non-operating)	10 to 500 Hz @ 30 m/s ² (3 G peak); displacement of 0.35 mm; 60 min. per axis for all X, Y, Z directions in acc. with IEC 60068-2-6
Shock (in all directions)	30 G (300 m/s ²) in all directions according to IEC 60068-2-27
Pollution degree	2
Climatic class	3K3 according to EN 60721
Certification and Standards	
Electrical equipments of machines	IEC 60204-1 (over voltage category III)
Electronic equipment for use in electrical power installations	EN 62477-1 / IEC 62103
Safety entry low voltage	PELV (EN 60204), SELV (EN 60950)
Industrial control equipment	cULus listed to UL 508 and CSA C22.2 No.107.1-01, CSA to CSA C22.2 No.107.1-01 (File No. 250468)
Hazardous location	cCSAus to CSA C22.2 No.213-M1987, ANSI / ISA 12.12.01:2007 [Class I, Division 2, Group A,B,C,D T4, T _a = -25°C to +80°C (> +50°C derating)]
Protection against electric shock	DIN 57100-410
CE	In conformance with EMC directive 2014/30/EU and low voltage directive 2014/35/EU
Component Power Supply for general use	EN 61204-3
ITE	EN 55032, EN 61000-3-2, EN 61000-3-3, EN 55024
Industrial	EN 55011
Limitation of mains harmonic currents	EN 61000-3-2
	   
RoHS Compliant	Yes
Safety and Protection	
Transient surge voltage protection	VARISTOR
Current limitation at short-circuits approx.	I _{surge} = 150 % of P _{Omax} typically
Surge voltage protection against internal surge voltages	Yes
Isolation voltage:	
Input / output (type test/routine test)	4 kVAC / 3 kVAC
Input / PE (type test/routine test)	1.5 kVAC / 1.5 kVAC
Output / PE (type test/routine test)	1.5 kVAC / 500 VAC
Protection degree	IP20
Safety class	Class I with PE connection