



Product designation	Miniature circuit breaker (MCB)
Product type designation	P1 MB
Number of poles	3P
Number of DIN modules	3
Compliance	IEC / UL489

### Electrical features

Rated insulation voltage $U_i$ IEC/EN	V	440
Rated impulse withstand voltage $U_{imp}$	kV	4
Rated operational voltage AC (IEC)	VAC	230/400
Rated operational voltage AC (UL)	V	480Y/277
Rated frequency	Hz	50/60
Rated current ( $I_n$ )	A	5
Tripping curve		D
Short circuit rating (IEC)	kA	10
Short circuit rating (UL)	kA	10
Electrical life	cycles	10000
Power dissipation per pole max	W	1.04

### Ambient conditions

Operating temperature	min	°C	-40
	max	°C	+70
Storage temperature	min	°C	-40
	max	°C	+80
Max altitude	m		2000

### Mechanical features

Operating position	normal	Vertical plan		
Fixing		35mm DIN rail		
Tightening torque for terminals	min	Nm	1.8	
	max	Nm	2	
	min	lbin	16	
	max	lbin	17.7	
Terminals tool		Pz 2		
Conductor section	IEC	min	mm <sup>2</sup>	1
		max	mm <sup>2</sup>	35
	AWG/Kcmil	min		14
		max		6
Mechanical life	cycles		20000	
Weight	g		388	

Frontal IP degree	IP20
Pollution degree	2

**Dimensions**

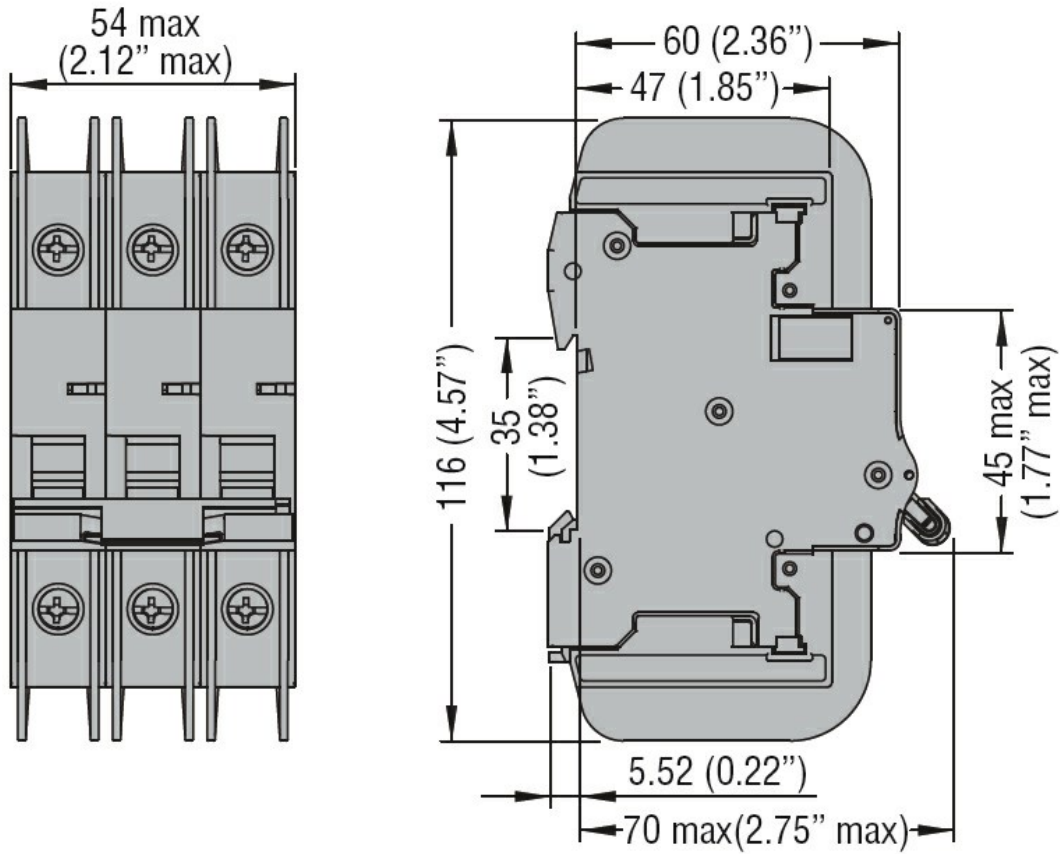

**Wiring diagrams**

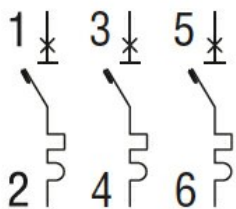

**Certifications and compliance**

Compliance	IEC/EN 60947-2
	UL489
Certifications	cULus
	EAC

**ETIM classification**

ETIM 8.0	EC000042 - Miniature circuit breaker (MCB)
----------	--