



KTX-WP9114125UZZZZ

KTX

CONTRAST SENSORS

SICK
Sensor Intelligence.



Illustration may differ



Ordering information

Type	Part no.
KTX-WP9114125UZZZZ	1223321

Other models and accessories → www.sick.com/KTX

Detailed technical data

Features

Special applications	Transmission color selection via cable
Device type	Standard
Dimensions (W x H x D)	30 mm x 53 mm x 78.5 mm
Sensing distance	≤ 13 mm
Sensing distance tolerance	± 5 mm
Housing design	Large
Light source	LED, RGB ¹⁾
Wave length	470 nm, 525 nm, 625 nm
Light emission	Long side of housing
Light spot size	0.9 mm x 3.8 mm
Light spot direction	Vertical ²⁾
Receiving filters	None
Teach-in mode	2-point teach-in
Output function	Light/dark switching
Delay time	Adjustable
Special features	-
Delivery status	2-point teach-in
Parameter presettings	Full access to all settings
Setting the key lock	Standard

¹⁾ Average service life: 100,000 h at T_U = +25 °C.

²⁾ In relation to long side of housing.

Mechanics/electronics

Supply voltage	10.8 V DC ... 28.8 V DC ¹⁾
Ripple	$\leq 5 V_{pp}$ ²⁾
Current consumption	$< 100 \text{ mA}$ ³⁾
Switching frequency	50 kHz ^{4) 5)}
Response time	10 μs ^{6) 7)}
Jitter	5 μs ⁸⁾
Switching output	PNP
Switching output (voltage)	PNP: HIGH = $V_S - 3 \text{ V}$ / LOW = 0 V
Output current $I_{max.}$	100 mA ⁹⁾
Input, teach-in (ET)	Teach: U = 10 V ... $< V_S$
Input, blanking input (AT)	Blanked: U = 10 V ... $< U_v$
Input, fine/coarse (F/C)	Coarse: U = 10 V ... $< U_v$
Input, light/dark (L/D)	Light: U = 10 V ... $< U_v$
Retention time (ET)	25 ms, non-volatile memory
Connection type	Male connector M12, 5-pin
Protection class	III
Circuit protection	U_v connections, reverse polarity protected Output Q short-circuit protected Interference pulse suppression
Enclosure rating	IP67
Weight	94 g
Housing material	Plastic, VISTAL®
Optics material	Plastic, COP

¹⁾ Limit values: DC 12 V (-10 %) ... DC 24 V (+20 %). Operation in short-circuit protected network max. 8 A.

²⁾ May not exceed or fall below U_v tolerances.

³⁾ Without load.

⁴⁾ With light/dark ratio 1:1.

⁵⁾ 1-point teach-in (color mode): 16 kHz.

⁶⁾ Signal transit time with resistive load.

⁷⁾ 1-point teach-in (color mode): 30 μs .

⁸⁾ 1-point teach-in (color mode): 15 μs .

⁹⁾ Total current of all Outputs.

Communication interface

Analog	✓, Analog output (voltage)
Analog output	Q _A
Number	1
Type	Voltage output
Voltage	0 V ... 5 V
Digital output	Q ₁
Number	1
Digital input	In ₁
Number	1

Ambient data

Ambient operating temperature	-20 °C ... +60 °C
Ambient temperature, storage	-25 °C ... +75 °C
Shock load	According to IEC 60068-2-27 (30 g/11 ms)
UL File No.	E181493

Classifications

ECLASS 5.0	27270906
ECLASS 5.1.4	27270906
ECLASS 6.0	27270906
ECLASS 6.2	27270906
ECLASS 7.0	27270906
ECLASS 8.0	27270906
ECLASS 8.1	27270906
ECLASS 9.0	27270906
ECLASS 10.0	27270906
ECLASS 11.0	27270906
ECLASS 12.0	27270906
ETIM 5.0	EC001820
ETIM 6.0	EC001820
ETIM 7.0	EC001820
ETIM 8.0	EC001820
UNSPSC 16.0901	39121528

Dimensional drawing (Dimensions in mm (inch))

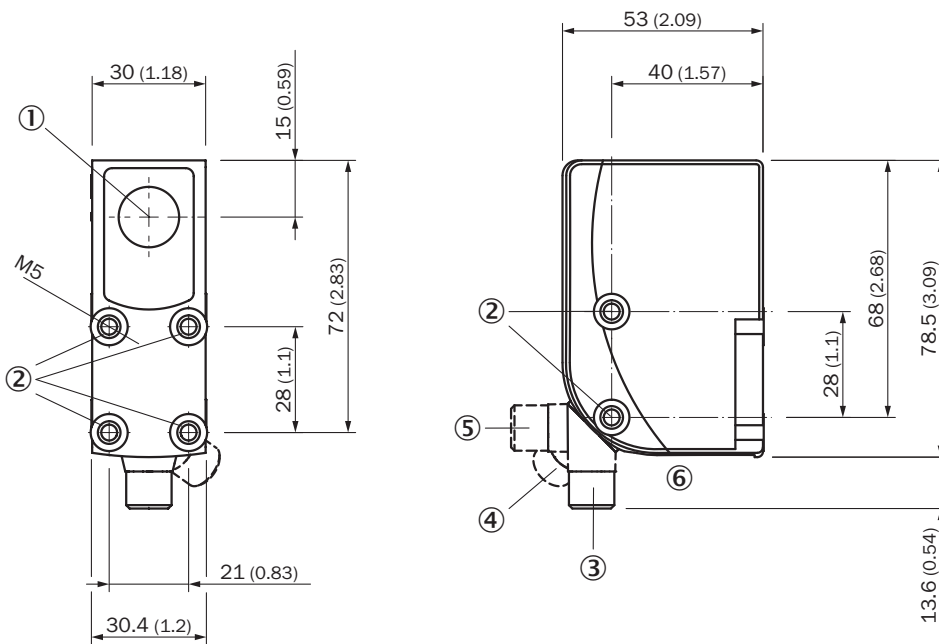

- ① Optical axis
- ② Threaded mounting hole M5
- ③ M12 male connector, delivery state
- ④ M12 male connector, end stop right
- ⑤ M12 male connector, end stop left
- ⑥ Display and adjustment elements

Adjustments

Display and adjustment elements

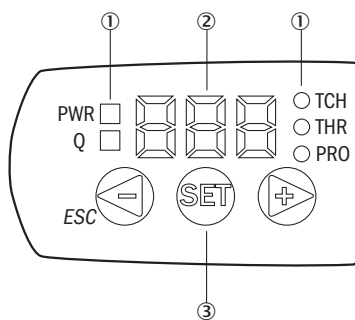

- ① LED status indicator
- ② Display
- ③ Navigation buttons

Connection diagram

Cd-385

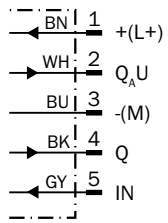

Concept of operation

KTS/KTX Prime - setting the switching threshold (2-point teach-in)

Suitable for manual positioning of the object to be detected, e.g. marks and background.

1. Position mark



When setting the contrasts to be detected, "1st" flashes. Press set button.

2. Position background



When setting the contrasts to be detected, "2nd" flashes. Press set button. The Quality of Teach is displayed.

KTS/KTX Prime - Setting the switching threshold (teach-in dynamic)

Suitable for teaching in moving objects.

1. Position background



Press the Set pushbutton to start the teach-in process.

2. Move at least the mark and background using the light spot



The display lights up during repeat length detection (- - -).



Press the Set pushbutton to end the teach-in process. The Quality of Teach is displayed.

Example



Switching characteristics

The optimum emitted light is selected automatically (at RGB variants).

Static teach-in: light/dark setting is defined using teach-in sequence.

Dynamic teach-in: switching output active on mark, if background is longer in the field of view during the teach-in.

The switching threshold is set in the center between the background and the mark.

Keylock (activation and deactivation): Press and hold the “+” pushbutton > 10 s.

The Q-LED (yellow) flashes and the “Err” error message appears on the display.



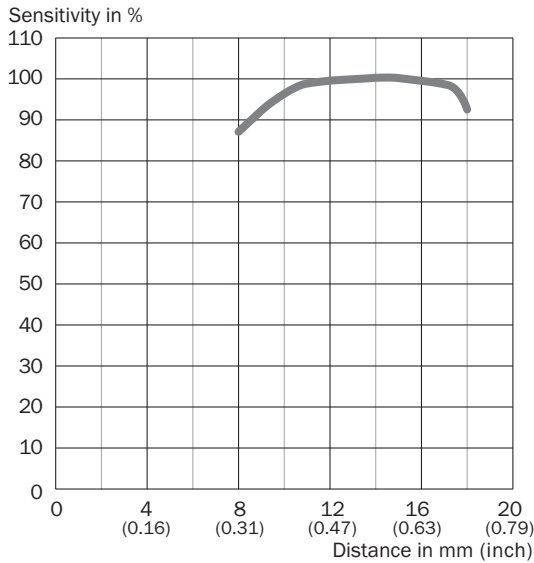

Sensing distance

Sensing distance 13 mm, light spot direction horizontal/vertical



Recommended accessories

Other models and accessories → www.sick.com/KTX

	Brief description	Type	Part no.
Universal bar clamp systems			
	Plate G for universal clamp bracket, steel, zinc coated, Universal clamp (2022726), mounting hardware	BEF-KHS-G01	2022464
	Mounting bar, straight, 200 mm, steel, steel, zinc coated, without mounting hardware	BEF-MS12G-A	4056054
	Mounting bar, L-shaped, 150 mm x 150 mm, steel, steel, zinc coated, without mounting hardware	BEF-MS12L-A	4056052
Plug connectors and cables			
	<ul style="list-style-type: none"> • Connection type head A: Female connector, M12, 5-pin, straight, A-coded • Connection type head B: Flying leads • Signal type: Sensor/actuator cable • Cable: 5 m, 5-wire, PVC • Description: Sensor/actuator cable, unshielded • Application: Zones with chemicals 	YF2A15-050VB5XLEAX	2096240
	<ul style="list-style-type: none"> • Connection type head A: Male connector, M12, 5-pin, straight • Description: Unshielded, Head A: male connector, M12, 5-pin, straight, unshielded, for cable diameter 4 mm ... 6 mm Head B: - • Connection systems: Screw-type terminals • Permitted cross-section: ≤ 0.75 mm² • Note: For field bus technology 	STE-1205-G	6022083

SICK AT A GLANCE

SICK is one of the leading manufacturers of intelligent sensors and sensor solutions for industrial applications. A unique range of products and services creates the perfect basis for controlling processes securely and efficiently, protecting individuals from accidents and preventing damage to the environment.

We have extensive experience in a wide range of industries and understand their processes and requirements. With intelligent sensors, we can deliver exactly what our customers need. In application centers in Europe, Asia and North America, system solutions are tested and optimized in accordance with customer specifications. All this makes us a reliable supplier and development partner.

Comprehensive services complete our offering: SICK LifeTime Services provide support throughout the machine life cycle and ensure safety and productivity.

For us, that is “Sensor Intelligence.”

WORLDWIDE PRESENCE:

Contacts and other locations –www.sick.com