

DFS60E-S4EB02000

DFS60

INCREMENTAL ENCODERS

SICK
Sensor Intelligence.



Illustration may differ



Ordering information

Type	Part no.
DFS60E-S4EB02000	1058446

Other models and accessories → www.sick.com/DFS60

Detailed technical data

Performance

Pulses per revolution	2,000 ¹⁾
Measuring step	90°, electric/pulses per revolution
Measuring step deviation at non binary number of lines	± 0.2°
Error limits	± 0.3°

¹⁾ See maximum revolution range.

Interfaces

Communication interface	Incremental
Communication Interface detail	HTL / Push pull
Number of signal channels	6-channel
Initialization time	40 ms
Output frequency	≤ 300 kHz
Load current	≤ 30 mA
Power consumption	≤ 0.5 W (without load)

Electrical data

Connection type	Male connector, M23, 12-pin, axial
Supply voltage	10 ... 32 V
Reference signal, number	1
Reference signal, position	90°, electric, logically gated with A and B
Reverse polarity protection	✓
Short-circuit protection of the outputs	✓ ¹⁾
MTTFd: mean time to dangerous failure	300 years (EN ISO 13849-1) ²⁾

¹⁾ Short-circuit opposite to another channel, US or GND permissible for maximum 30 s.

²⁾ This product is a standard product and does not constitute a safety component as defined in the Machinery Directive. Calculation based on nominal load of components, average ambient temperature 40°C, frequency of use 8760 h/a. All electronic failures are considered hazardous. For more information, see document no. 8015532.

Mechanical data

Mechanical design	Solid shaft, face mount flange
Shaft diameter	10 mm
Shaft length	19 mm
Weight	+ 0.3 kg
Shaft material	Stainless steel
Flange material	Aluminum
Housing material	Aluminum die cast
Start up torque	0.5 Ncm (+20 °C)
Operating torque	0.3 Ncm (+20 °C)
Permissible shaft loading	80 N (radial) 40 N (axial)
Operating speed	≤ 9,000 min ⁻¹ ¹⁾
Moment of inertia of the rotor	6.2 gcm ²
Bearing lifetime	3.6 x 10 ¹⁰ revolutions
Angular acceleration	≤ 500,000 rad/s ²

¹⁾ Allow for self-heating of 3.3 K per 1,000 rpm when designing the operating temperature range.

Ambient data

EMC	According to EN 61000-6-2 and EN 61000-6-4
Enclosure rating	IP67, Housing side, male connector (IEC 60529) ¹⁾ IP65, shaft side (IEC 60529)
Permissible relative humidity	90 % (Condensation not permitted)
Operating temperature range	0 °C ... +85 °C
Storage temperature range	-40 °C ... +100 °C, without package
Resistance to shocks	50 g, 6 ms (EN 60068-2-27)
Resistance to vibration	20 g, 10 Hz ... 2,000 Hz (EN 60068-2-6)

¹⁾ With mating connector fitted.

Classifications

eCl@ss 5.0	27270501
eCl@ss 5.1.4	27270501
eCl@ss 6.0	27270590
eCl@ss 6.2	27270590
eCl@ss 7.0	27270501
eCl@ss 8.0	27270501
eCl@ss 8.1	27270501
eCl@ss 9.0	27270501
eCl@ss 10.0	27270501
eCl@ss 11.0	27270501
eCl@ss 12.0	27270501
ETIM 5.0	EC001486
ETIM 6.0	EC001486

ETIM 7.0	EC001486
ETIM 8.0	EC001486
UNSPSC 16.0901	41112113

Dimensional drawing (Dimensions in mm (inch))

Face mount flange, M12 and M23 axial male connector

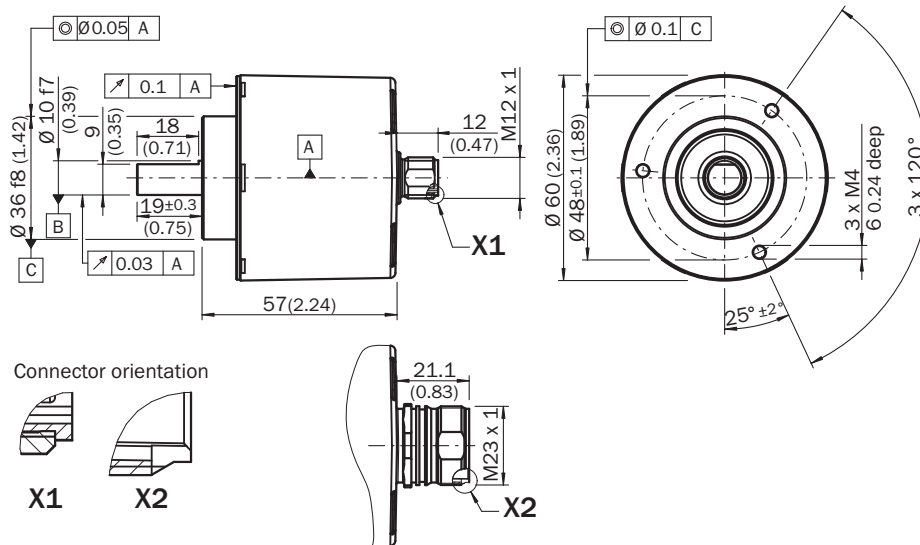

General tolerances according to DIN ISO 2768-mk

PIN assignment

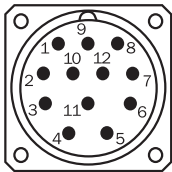

View of M23 male device connector on encoder

PIN Male connector M12, 8-pin	PIN Male connector M23, 12-pin	Wire colors (cable connection)	TTL/HTL signal	Sin/Cos 1.0 V _{pp}	Explanation
1	6	Brown	\bar{A}	COS-	Signal wire
2	5	White	A	COS+	Signal wire
3	1	Black	\bar{B}	SIN-	Signal wire
4	8	Pink	B	SIN+	Signal wire
5	4	Yellow	\bar{Z}	\bar{Z}	Signal wire
6	3	Purple	Z	Z	Signal wire
7	10	Blue	GND	GND	Ground connection
8	12	Red	+U _S	+U _S	Supply voltage
-	9	-	N.c.	N.c.	Not assigned

PIN Male connector M12, 8-pin	PIN Male connector M23, 12-pin	Wire colors (cable connection)	TTL/HTL signal	Sin/Cos 1.0 V _{pp}	Explanation
-	2	-	N.c.	N.c.	Not assigned
-	11	-	N.c.	N.c.	Not assigned
-	7 ¹⁾	Orange	0-SET ¹⁾	N.c.	Set zero pulse ¹⁾
Screen	Screen	Screen	Screen	Screen	Screen connected to housing on encoder side. Connected to ground on control side.

1)

For electrical interfaces only: M, U, V, W with 0-SET function on PIN 7 on M23 plug. The 0-SET input is used to set the zero pulse to the current shaft position. If the 0-SET input is applied to US for longer than 250 ms after it has previously been open or applied to GND for at least 1,000 ms, the current shaft position is assigned zero pulse signal "Z".

Diagrams

Signal outputs

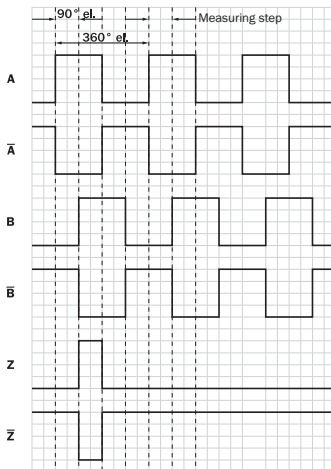

CW with view on the encoder shaft in direction "A", compare dimensional drawing.

Maximum revolution range



Supply voltage	Output
4,5 V ... 5,5 V	TTL
10 V ... 32 V	TTL
10 V ... 32 V	HTL

Recommended accessories





Other models and accessories → www.sick.com/DFS60

	Brief description	Type	Part no.
Flanges			
	Flange adapter, adaptation of face mount flange with 36 mm centering hub to 50 mm servo flange, aluminum, including 3 flat head screws M4 x 10, Aluminum, including 3 countersunk screws M3 x 10	BEF-FA-036-050	2029160
	Flange adapter, adaptation of face mount flange with 36 mm centering hub to 60 mm square mounting plate, aluminum, including 3 flat head screws M4 x 8, Aluminum, including 3 countersunk screws M4 x 8	BEF-FA-036-060REC	2029162
	Flange adapter, adaptation of face mount flange with 36 mm centering hub to 58 mm square mounting plate with shock absorbers, aluminum, Aluminum	BEF-FA-036-060RSA	2029163
	Flange adapter, adaptation of face mount flange with 36 mm centering hub to 63 mm square mounting plate, aluminum, including 3 flat head screws M4 x 10, Aluminum, including 3 countersunk screws M3 x 10	BEF-FA-036-063REC	2034225
	Flange adapter, adaptation of face mount flange with 36 mm centering hub to 100 mm servo flange with 60 mm centering hub, aluminum, Aluminum	BEF-FA-036-100	2029161
Mounting brackets and plates			
	Mounting bracket for encoder with spigot 36 mm for face mount flange, mounting kit included	BEF-WF-36	2029164

	Brief description	Type	Part no.
	Mounting angle spring-loaded, for flange with centerring collar 36 mm, working temperature range -40 ° ... +120 °C, Aluminum	BEF-WF36F	4084775
Other mounting accessories			
	Aluminium measuring wheel with O-ring (NBR70) for 10 mm solid shaft, circumference 200 mm	BEF-MR010020R	2055224
	Aluminium measuring wheel with O-ring (NBR70) for 10 mm solid shaft, circumference 300 mm	BEF-MR010030R	2049278
	Measuring wheel with O-ring (NBR70) for 10 mm solid shaft, circumference 500 mm	BEF-MR010050R	2055227
	Aluminum measuring wheel with studded polyurethane surface for 6 mm solid shaft, circumference 200 mm	BEF-MR06200APN	4084747
	Aluminum measuring wheel with cross-knurled surface for 10 mm solid shaft, circumference 200 mm	BEF-MR10200AK	4084737
	Aluminum measuring wheel with smooth polyurethane surface for 10 mm solid shaft, circumference 200 mm	BEF-MR10200AP	4084738
	Aluminum measuring wheel with studded polyurethane surface for 10 mm solid shaft, circumference 200 mm	BEF-MR10200APN	4084739
	Aluminum measuring wheel with cross-knurled surface for 10 mm solid shaft, circumference 500 mm	BEF-MR10500AK	4084733
	Aluminum measuring wheel with smooth polyurethane surface for 10 mm solid shaft, circumference 500 mm	BEF-MR10500AP	4084734
	Aluminum measuring wheel with ridged polyurethane surface for 10 mm solid shaft, circumference 500 mm	BEF-MR10500APG	4084736
	Aluminum measuring wheel with studded polyurethane surface for 10 mm solid shaft, circumference 500 mm	BEF-MR10500APN	4084735
	SICK modular measuring wheel system for face mount flange encoder with S4 mechanical design (10 mm x 19 mm solid shaft), e.g., DFS60-S4: with O-ring measuring wheel, circumference 200 mm	BEF-MRS-10-U	2085714
	Flange adapter (adapts size 60 face mount flange encoder to bearing block with part. no. 2044591)	BEF-FA-036-050-019	2063378
	Bearing block for servo and face mount flange encoder. The heavy-duty bearing block is used to absorb very large radial and axial shaft loads. Particularly when using belt pulleys, chain sprockets, friction wheels. Operating speed max. 4,000 rpm^-1, axial shaft load 150 N, radial shaft load 250 N, bearing service life 3.6 x 10^9 revolutions	BEF-FA-LB1210	2044591
Plug connectors and cables			
	Head A: female connector, M23, 12-pin, straight Head B: Flying leads Cable: Incremental, PUR, shielded, 2 m	DOL-2312-G02MLA3	2030682
	Head A: female connector, M23, 12-pin, straight Head B: Flying leads Cable: Incremental, PUR, halogen-free, shielded, 3 m	DOL-2312-G03MMA3	2029213

	Brief description	Type	Part no.
	Head A: female connector, M23, 12-pin, straight Head B: Flying leads Cable: Incremental, PUR, halogen-free, shielded, 5 m	DOL-2312-G05MMA3	2029214
	Head A: female connector, M23, 12-pin, straight Head B: Flying leads Cable: Incremental, PUR, shielded, 7 m	DOL-2312-G07MLA3	2030685
	Head A: female connector, M23, 12-pin, straight Head B: Flying leads Cable: Incremental, PUR, shielded, 10 m	DOL-2312-G10MLA3	2030688
	Head A: female connector, M23, 12-pin, straight Head B: Flying leads Cable: Incremental, PUR, halogen-free, shielded, 10 m	DOL-2312-G10MMA3	2029215
	Head A: female connector, M23, 12-pin, straight Head B: Flying leads Cable: Incremental, PUR, shielded, 15 m	DOL-2312-G15MLA3	2030692
	Head A: female connector, M23, 12-pin, straight Head B: Flying leads Cable: Incremental, PUR, halogen-free, shielded, 1.5 m	DOL-2312-G1M5MA3	2029212
	Head A: female connector, M23, 12-pin, straight Head B: Flying leads Cable: Incremental, PUR, shielded, 20 m	DOL-2312-G20MLA3	2030695
	Head A: female connector, M23, 12-pin, straight Head B: Flying leads Cable: Incremental, PUR, halogen-free, shielded, 20 m	DOL-2312-G20MMA3	2029216
	Head A: female connector, M23, 12-pin, straight Head B: Flying leads Cable: Incremental, PUR, shielded, 25 m	DOL-2312-G25MLA3	2030699
	Head A: female connector, M23, 12-pin, straight Head B: Flying leads Cable: Incremental, PUR, shielded, 30 m	DOL-2312-G30MLA3	2030702
	Head A: female connector, M23, 12-pin, straight Head B: Flying leads Cable: Incremental, PUR, halogen-free, shielded, 30 m	DOL-2312-G30MMA3	2029217
	Head A: female connector, M23, 12-pin, straight Cable: HIPERFACE®, SSI, Incremental, shielded	DOS-2312-G02	2077057
	Head A: female connector, M23, 12-pin, angled Cable: HIPERFACE®, SSI, Incremental, shielded	DOS-2312-W01	2072580

Shaft adaptation

	Bellows coupling, shaft diameter 6 mm / 10 mm, maximum shaft offset: radial \pm 0.25 mm, axial \pm 0.4 mm, angular \pm 4°; max. speed 10,000 rpm, -30 °C to +120 °C, max. torque 120 Ncm; material: stainless steel bellows, aluminum hub	KUP-0610-B	5312982
	Double loop coupling, shaft diameter 6 mm / 10 mm, max. shaft offset: radially \pm 2,5 mm, axially \pm 3 mm, angle \pm 10 degrees; max. speed 3.000 rpm, -30 to +80 degrees Celsius, torsional spring stiffness of 25 Nm/rad	KUP-0610-D	5326697
	Spring washer coupling, shaft diameter 6 mm / 10 mm, Maximum shaft offset: radial \pm 0.3 mm, axial \pm 0.4 mm, angular \pm 2.5°; max. speed 12,000 rpm, -10° to +80 °C, max. torque 60 Ncm; material: aluminum flange, glass fiber-reinforced polyamide membrane and hardened steel coupling pin	KUP-0610-F	5312985
	Claw coupling, shaft diameter 6 mm / 10 mm, damping element 80 shore blue, maximum shaft offset: radial \pm 0.22 mm, axial \pm 1 mm angular \pm 1.3°, max. speed 19,000 rpm, angle of twist max. 10°, -30 °C to +80 °C, max. torque 800 Ncm, tightening torque of screws: ISO 4029 150 Ncm, material: aluminum flange, damping element: polyurethane	KUP-0610-J	2127056

	Brief description	Type	Part no.
	Bar coupling, shaft diameter 6 mm / 10 mm, max. shaft offset: radial $\pm 0,3$ mm, axial $\pm 0,3$ mm, angular $\pm 3^\circ$; max. speed 10.000 rpm, -10° to $+80^\circ$ C, max. torque: 80 Ncm, material: fiber-glass reinforced polyamide, aluminum hub	KUP-0610-S	2056407
	Double loop coupling, shaft diameter 8 mm / 10 mm, max. shaft offset: radially $\pm 0,25$ mm, axially $\pm 0,4$ mm, angle ± 4 degrees; max. speed 10.000 rpm, -30 to $+120$ degrees Celsius, torsional spring stiffness of 150 Nm/rad	KUP-0810-D	5326704
	Claw coupling, shaft diameter 8 mm / 10 mm, damping element 80 shore blue, maximum shaft offset: radial $\pm 0,22$ mm, axial ± 1 mm angular $\pm 1,3^\circ$, max. speed 19,000 rpm, angle of twist max. 10° , -30° C to $+80^\circ$ C, max. torque 800 Ncm, tightening torque of screws: ISO 4029 150 Ncm, material: aluminum flange, damping element: polyurethane	KUP-0810-J	2128267
	Bar coupling, shaft diameter 8 mm / 10 mm, max. shaft offset: radial $\pm 0,3$ mm, axial $\pm 0,3$ mm, angular $\pm 3^\circ$; max. speed 10.000 rpm, -10° to $+80^\circ$ C, max. torque: 80 Ncm, material: fiber-glass reinforced polyamide, aluminum hub	KUP-0810-S	5314178
	Bellows coupling, shaft diameter 10 mm/10 mm; maximum shaft offset: radial $\pm 0,25$ mm, axial $\pm 0,4$ mm, angular $\pm 4^\circ$; max. revolutions 10,000 rpm, -30° to $+120^\circ$ C, max. torque 120 Ncm; material: stainless steel bellows, aluminum clamping hubs	KUP-1010-B	5312983
	Double loop coupling, shaft diameter 10 mm / 10 mm, Maximum shaft offset: radial $\pm 2,5$ mm, axial ± 3 mm, angular $\pm 10^\circ$; max. speed 3,000 rpm, -30° to $+80^\circ$ C, max. torque 1,5 Nm; material: polyurethane, galvanized steel flange	KUP-1010-D	5326703
	Spring washer coupling, shaft diameter 10 mm / 10 mm, maximum shaft offset, radial $\pm 0,3$ mm, axial $\pm 0,4$ mm, angle $\pm 2,5^\circ$, torsion spring stiffness 30 Nm/rad; material: aluminum flange, glass-fiber reinforced polyamide membrane and hardened steel coupling pin	KUP-1010-F	5312986
	Claw coupling, shaft diameter 10 mm / 10 mm, damping element 80 shore blue, maximum shaft offset: radial $\pm 0,22$ mm, axial ± 1 mm angular $\pm 1,3^\circ$, max. speed 19,000 rpm, angle of twist max. 10° , -30° C to $+80^\circ$ C, max. torque 800 Ncm, tightening torque of screws: ISO 4029 150 Ncm, material: aluminum flange, damping element: polyurethane	KUP-1010-J	2127054
	Bar coupling, shaft diameter 10 mm / 10 mm; maximum shaft offset: radial $\pm 0,3$ mm, axial $\pm 0,2$ mm, angular $\pm 3^\circ$; speed 10,000 rpm, -10° to $+80^\circ$ Celsius, max. torque 80 Ncm; material: glass fiber-reinforced polyamide, aluminum hub	KUP-1010-S	2056408
	10 mm / 12 mm; maximum shaft offset: radial $\pm 0,25$ mm, axial $\pm 0,4$ mm, angular $\pm 4^\circ$; max. revolutions 10,000 rpm, -30° to $+120^\circ$ C, max. torque 120 Ncm; material: stainless steel bellows, aluminum clamping hubs	KUP-1012-B	5312984
	Double loop coupling, shaft diameter 10 mm / 12 mm, Maximum shaft offset: radial $\pm 2,5$ mm, axial ± 3 mm, angular $\pm 10^\circ$; max. speed 3,000 rpm, -30° to $+80^\circ$ C, max. torque 1,5 Nm; material: polyurethane, galvanized steel flange	KUP-1012-D	5326702
	Claw coupling, shaft diameter 10 mm / 12 mm, damping element 80 shore blue, maximum shaft offset: radial $\pm 0,22$ mm, axial ± 1 mm angular $\pm 1,3^\circ$, max. speed 19,000 rpm, angle of twist max. 10° , -30° C to $+80^\circ$ C, max. torque 800 Ncm, tightening torque of screws: ISO 4029 150 Ncm, material: aluminum flange, damping element: polyurethane	KUP-1012-J	2128265

SICK AT A GLANCE

SICK is one of the leading manufacturers of intelligent sensors and sensor solutions for industrial applications. A unique range of products and services creates the perfect basis for controlling processes securely and efficiently, protecting individuals from accidents and preventing damage to the environment.

We have extensive experience in a wide range of industries and understand their processes and requirements. With intelligent sensors, we can deliver exactly what our customers need. In application centers in Europe, Asia and North America, system solutions are tested and optimized in accordance with customer specifications. All this makes us a reliable supplier and development partner.

Comprehensive services complete our offering: SICK LifeTime Services provide support throughout the machine life cycle and ensure safety and productivity.

For us, that is “Sensor Intelligence.”

WORLDWIDE PRESENCE:

Contacts and other locations –www.sick.com