



# THTS-1AAC20506MZ

THTS

RESISTANCE THERMOMETER

**SICK**  
Sensor Intelligence.



Illustration may differ



## Ordering information

Type	Part no.
THTS-1AAC20506MZ	6047712

Other models and accessories → [www.sick.com/THTS](http://www.sick.com/THTS)

## Detailed technical data

### Features

<b>Measuring range</b>	-50 °C ... +150 °C
<b>Sensor element</b>	Pt100, Pt1000 (for 4 mA ... 20 mA version)
<b>Output signal</b>	4 mA ... 20 mA, 2-wire
<b>Maximum ohmic load <math>R_A</math></b>	$R_A \leq (L^+ - 10 \text{ V}) / 0.023 \text{ A}$ [Ohm]

### Mechanics/electronics

<b>Process connection</b>	Clamp (ISO 2852) DN 12, DN 12.7, DN 17.2, DN 21.3
<b>Insertion length/diameter of probe</b>	50 mm / 6 mm
<b>Wetted parts</b>	Stainless steel 1.4435 / 316L, $R_a \leq 0.8 \mu\text{m}$
<b>Pressure resistance</b>	Max. 16 bar at room temperature
<b>Housing material</b>	Stainless steel (CrNi)
<b>Connection type</b>	M12 round connector x 1, 4-pin <sup>1)</sup>
<b>Enclosure rating</b>	IP67 <sup>2)</sup> IP69 <sup>2)</sup>
<b>Supply voltage</b>	10 V DC ... 35 V DC
<b>Maximum current consumption</b>	Ca. 30 mA
<b>Electrical safety</b>	Protection class: III, dielectric strength: 500 V AC, Reverse polarity protection: L <sup>+</sup> to M
<b>Protection class III</b>	✓
<b>CE-conformity</b>	2004/108/EC, EN 61326-2-3
<b>RoHS certificate</b>	✓
<b>Initialization time</b>	Max. 4 s

<sup>1)</sup> The enclosure rating classes specified only apply while the thermometer is connected with female connectors that provide the corresponding enclosure rating.

<sup>2)</sup> IP enclosure rating as per IEC 60529.

### Performance

<b>Accuracy of sensor element</b>	Class A according to IEC 60751 <sup>1)</sup>
<b>Transmitter accuracy</b>	± 0,25 K

<sup>1)</sup> Class B (measuring range -50 °C ... -30 °C).

<sup>2)</sup> Depending on sensor configuration, according to IEC 60751.

<b>Transmitter linearity</b>	≤ ± 0.1 % of span
<b>Response time</b>	t <sub>50</sub> ≤ 3,3 s t <sub>90</sub> ≤ 9,7 s <sup>2)</sup>

<sup>1)</sup> Class B (measuring range -50 ° C ... -30 ° C).

<sup>2)</sup> Depending on sensor configuration, according to IEC 60751.

### Ambient data

<b>Ambient temperature</b>	-40 °C ... +85 °C
<b>Storage and transport temperature</b>	-40 °C ... +85 °C
<b>Shock resistance</b>	50 g, 6ms (according to IEC 60068-2-27)
<b>Relative humidity</b>	100 % <sup>1)</sup>

<sup>1)</sup> , Condensation allowed.

### Classifications

<b>eCl@ss 5.0</b>	27200208
<b>eCl@ss 5.1.4</b>	27200208
<b>eCl@ss 6.0</b>	27200208
<b>eCl@ss 6.2</b>	27200208
<b>eCl@ss 7.0</b>	27200208
<b>eCl@ss 8.0</b>	27200208
<b>eCl@ss 8.1</b>	27200208
<b>eCl@ss 9.0</b>	27200208
<b>eCl@ss 10.0</b>	27200208
<b>eCl@ss 11.0</b>	27200208
<b>eCl@ss 12.0</b>	27200208
<b>ETIM 5.0</b>	EC002994
<b>ETIM 6.0</b>	EC002994
<b>ETIM 7.0</b>	EC002994
<b>ETIM 8.0</b>	EC002994
<b>UNSPSC 16.0901</b>	41112211

### Dimensional drawing (Dimensions in mm (inch))

Dimensional drawing

Pt100, 4 mA...20 mA,  
up to 150 °C

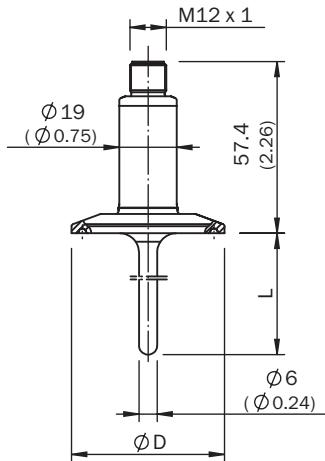

Pt100, 4 mA...20 mA,  
up to 250 °C

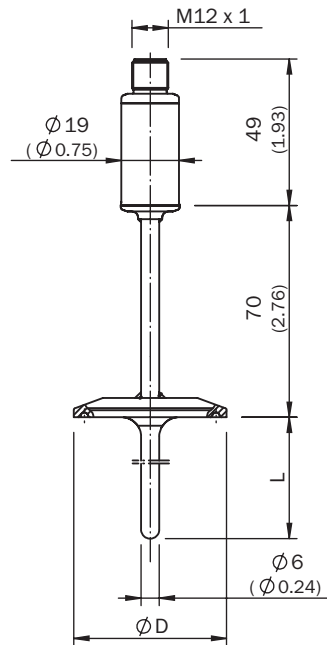

All dimensions in mm (inch)

Design		̢ D
<b>DIN 32676</b>	DN 10 ... DN 20	34.0 (1.34)
	DN 25 ... DN 40	50.5 (1.99)
	DN 50	64.0 (2.52)
<b>ISO 2852</b>	DN 12 ... DN 21.3	34.0 (1.34)
	DN 25 ... DN 38	50.5 (1.99)
	DN 40, DN 51	64.0 (2.52)
<b>Tri-Clamp</b>	1", 1 1/2"	50.5 (1.99)
	2"	64.0 (2.52)

## Application





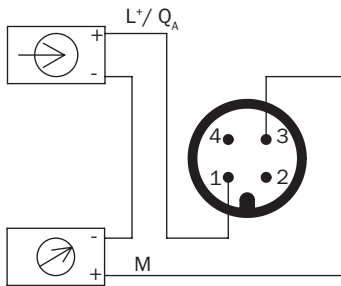

## Connection type







Plug M12 x 1, output signal 4 mA ... 20 mA



## Recommended accessories

Other models and accessories → [www.sick.com/THTS](http://www.sick.com/THTS)

	Brief description	Type	Part no.
<b>Plug connectors and cables</b>			
	Head A: female connector, M12, 4-pin, straight, A-coded Head B: Flying leads Cable: Sensor/actuator cable, PUR, halogen-free, unshielded, 2 m	YF2A14-020UB3XLEAX	2095607
	Head A: female connector, M12, 4-pin, straight, A-coded Head B: Flying leads Cable: Sensor/actuator cable, PVC, unshielded, 2 m	YF2A14-020VB3XLEAX	2096234
	Head A: female connector, M12, 4-pin, straight, A-coded Head B: Flying leads Cable: Sensor/actuator cable, PUR, halogen-free, unshielded, 5 m	YF2A14-050UB3XLEAX	2095608
	Head A: female connector, M12, 4-pin, straight, A-coded Head B: Flying leads Cable: Sensor/actuator cable, PVC, unshielded, 5 m	YF2A14-050VB3XLEAX	2096235
	Head A: female connector, M12, 4-pin, straight, A-coded Head B: Flying leads Cable: Sensor/actuator cable, PUR, halogen-free, unshielded, 10 m	YF2A14-100UB3XLEAX	2095609

	Brief description	Type	Part no.
	Head A: female connector, M12, 4-pin, straight, A-coded Head B: Flying leads Cable: Sensor/actuator cable, PVC, unshielded, 10 m	YF2A14-100VB3XLEAX	2096236
	Head A: female connector, M12, 4-pin, straight, A-coded Head B: Flying leads Cable: Sensor/actuator cable, PVC, unshielded, 15 m	YF2A14-150VB3XLEAX	2096237
	Head A: female connector, M12, 4-pin, angled, A-coded Head B: Flying leads Cable: Sensor/actuator cable, PUR, halogen-free, unshielded, 2 m	YG2A14-020UB3XLEAX	2095766
	Head A: female connector, M12, 4-pin, angled, A-coded Head B: Flying leads Cable: Sensor/actuator cable, PVC, unshielded, 2 m	YG2A14-020VB3XLEAX	2095895
	Head A: female connector, M12, 4-pin, angled, A-coded Head B: Flying leads Cable: Sensor/actuator cable, PUR, halogen-free, unshielded, 5 m	YG2A14-050UB3XLEAX	2095767
	Head A: female connector, M12, 4-pin, angled, A-coded Head B: Flying leads Cable: Sensor/actuator cable, PVC, unshielded, 5 m	YG2A14-050VB3XLEAX	2095897
	Head A: female connector, M12, 4-pin, angled, A-coded Head B: Flying leads Cable: Sensor/actuator cable, PUR, halogen-free, unshielded, 10 m	YG2A14-100UB3XLEAX	2095768
	Head A: female connector, M12, 4-pin, angled, A-coded Head B: Flying leads Cable: Sensor/actuator cable, PVC, unshielded, 10 m	YG2A14-100VB3XLEAX	2095898

## SICK AT A GLANCE

SICK is one of the leading manufacturers of intelligent sensors and sensor solutions for industrial applications. A unique range of products and services creates the perfect basis for controlling processes securely and efficiently, protecting individuals from accidents and preventing damage to the environment.

We have extensive experience in a wide range of industries and understand their processes and requirements. With intelligent sensors, we can deliver exactly what our customers need. In application centers in Europe, Asia and North America, system solutions are tested and optimized in accordance with customer specifications. All this makes us a reliable supplier and development partner.

Comprehensive services complete our offering: SICK LifeTime Services provide support throughout the machine life cycle and ensure safety and productivity.

For us, that is “Sensor Intelligence.”

## WORLDWIDE PRESENCE:

Contacts and other locations –[www.sick.com](http://www.sick.com)