



Product designation				Power contactor
Product type designation				BFK65
Contact characteristics				
Number of poles	Nr.			3
Rated insulation voltage U_i IEC/EN	V			690
Rated impulse withstand voltage U_{imp}	kV			8
Operational frequency	min	Hz	25	
	max	Hz	400	
IEC Conventional free air thermal current I_{th}	A			100
Rated operational power AC-6b ($T \leq 40^\circ C$)	230V	kvar	26	
	400V	kvar	45	
	440...480V	kvar	50	
	690V	kvar	56	
Short-time allowable current for 10s (IEC/EN60947-1)	A			640
Protection fuse	gG (IEC)	A	100	
		A	650	
Making capacity (RMS value)				650
Breaking capacity at voltage	440V	A	520	
	500V	A	425	
	690V	A	376	
Resistance per pole (average value)		m Ω	0.8	
Power dissipation per pole (average value)		lth	W	8
		min	Nm	4
Tightening torque for terminals		max	Nm	5
		min	Ibin	2.95
		max	Ibin	3.69
		min	Nm	0.8
Tightening torque for coil terminal		max	Nm	1
		min	Ibin	0.8
		max	Ibin	0.74
		min	Nm	0.8
Max number of wires simultaneously connectable	Nr.			2
Conductor section	AWG/Kcmil	max	2	
	Flexible w/o lug conductor section	min	mm ²	1.5
		max	mm ²	35
Flexible c/w lug conductor section	min	mm ²	1.5	

		max	mm ²	35
Power terminal protection according to IEC/EN 60529				IP20 front
Mechanical features				
Operating position		normal allowable		Vertical plan ±30°
Fixing				Screw / DIN rail 35mm
Weight			g	1090
Conductor section	AWG/kcmil conductor section	max		2
Operations				
Mechanical life			cycles	15000000
Electrical life			cycles	400000
Safety related data				
Performance level B10d according to EN/ISO 13489-1		rated load mechanical load	cycles cycles	400000 15000000
EMC compatibility				yes
AC coil operating				
Rated AC voltage at 60Hz			V	120
AC operating voltage	of 60Hz coil powered at 60Hz pick-up	min max	%Us %Us	80 110
	drop-out	min max	%Us %Us	20 55
AC average coil consumption at 20°C	of 60Hz coil powered at 60Hz	in-rush holding	VA VA	210 15
Dissipation at holding ≤20°C 50Hz			W	5
Max cycles frequency				
Mechanical operation			cycles/h	3600
Operating times				
Average time for Us control	in AC			
	Closing NO	min max	ms ms	12 28
	Opening NO	min max	ms ms	8 22
	in DC			
	Closing NO	min max	ms ms	40 85
	Opening NO	min max	ms ms	20 55
UL technical data				

General USE

Contactor

AC current A 100

Ambient conditions

Temperature

Operating temperature

min °C -50
max °C 70

Storage temperature

min °C -60
max °C 80

Max altitude

m 3000

Resistance & Protection

Pollution degree

3

Dimensions

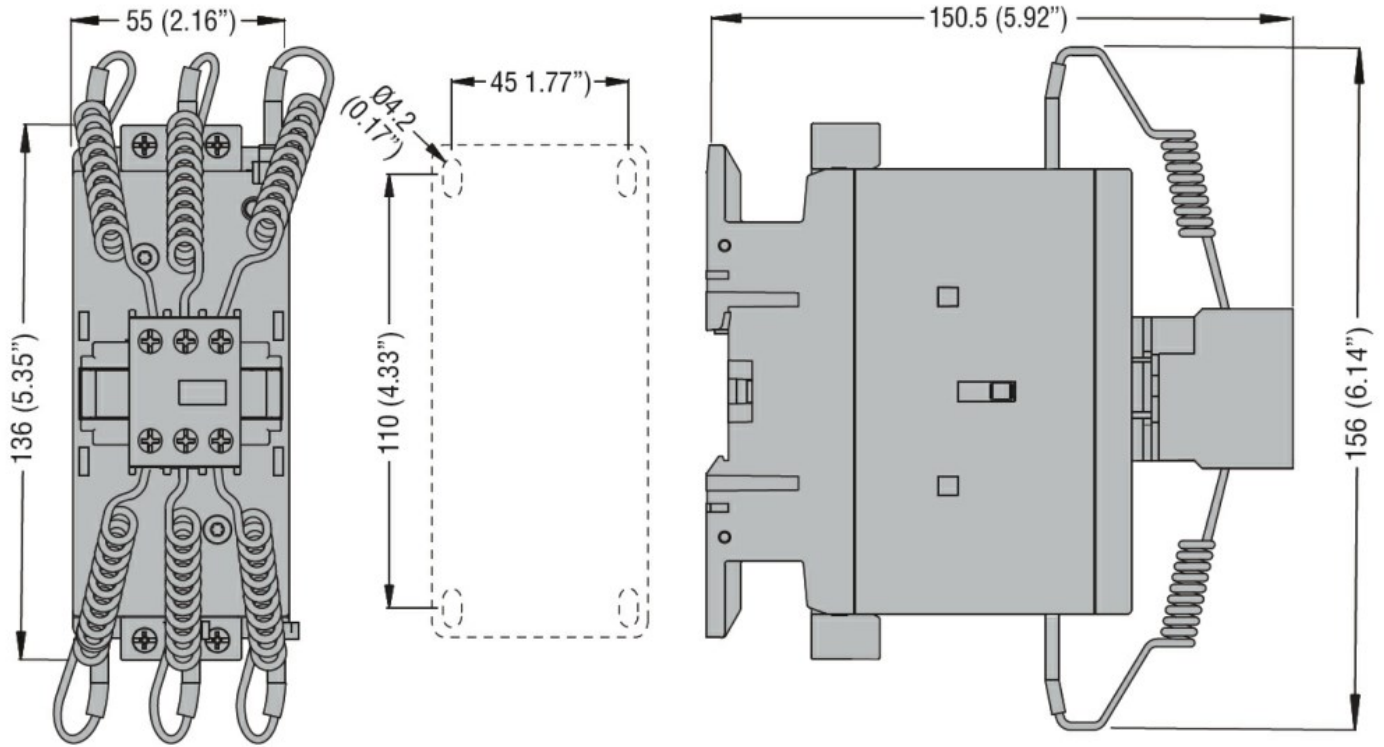

Wiring diagrams

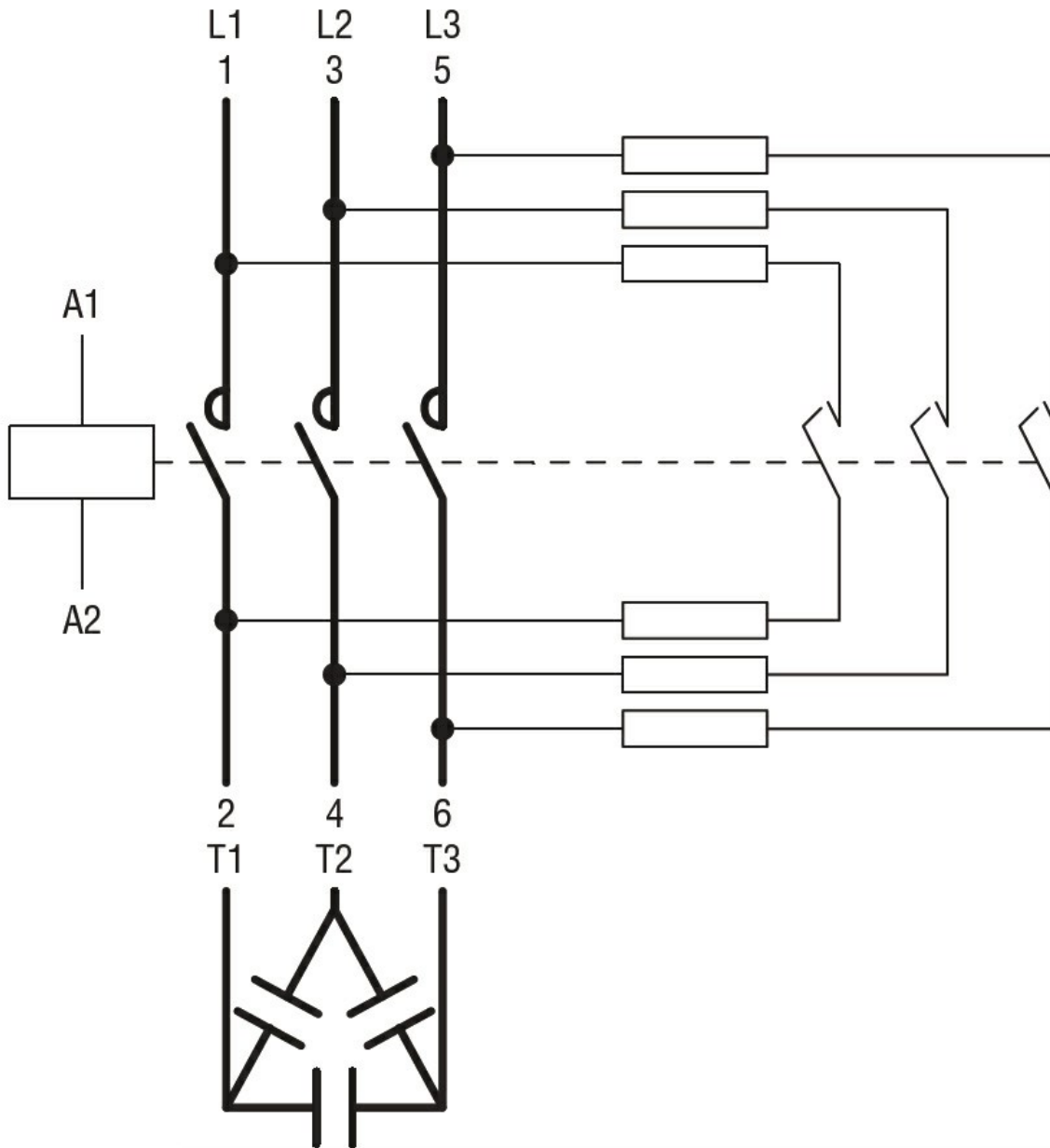

Certifications and compliance

Compliance

- CSA C22.2 n° 60947-1
- CSA C22.2 n° 60947-4-1
- IEC/EN/BS 60947-1
- IEC/EN/BS 60947-4-1
- UL 60947-1
- UL 60947-4-1

Certificates

- CCC
- cULus

ETIM classification

ETIM 8.0

EC001079 -
Capacitor
contactor