



CLV615-D2540

CLV61x Dual Port

FIXED MOUNT BAR CODE SCANNERS

SICK
Sensor Intelligence.



Ordering information

Type	Part no.
CLV615-D2540	1091389

Other models and accessories → www.sick.com/CLV61x_Dual_Port



Detailed technical data

Features

Version	Long Range
Connection type	Cable
Reading field	Side (105°)
Scanning method	Line scanning
Sensor type	Line scanner
Optical focus	Fixed focus
Light source	Light spot Laser, Visible, Red, 655 nm
Laser class	
Aperture angle	≤ 50°
Scanning frequency	400 Hz ... 1,000 Hz
Code resolution	0.35 mm ... 0.5 mm
Reading distance	25 mm ... 330 mm ¹⁾

¹⁾ For details see reading field diagram.

Mechanics/electronics

Connection type	1 x "POWER" connection, 5-pin M12 plug, A-coded 1 x "PROFINET P1" connection, 4-pin M12 socket, D-coded 1 x "PROFINET P2" connection, 4-pin M12 socket, D-coded
Supply voltage	10 V DC ... 30 V DC
Power consumption	5 W
Housing	Aluminum die cast
Housing color	Light blue (RAL 5012)
Front screen	Glass
Enclosure rating	IP65 (DIN 40 050)
Protection class	III (VDE 0106/IEC 1010-1)

¹⁾ At 25 °C.

Weight	310.5 g
Dimensions (L x W x H)	80 mm x 96 mm x 38 mm
MTBF	100,000 h
MTTF	40,000 h (Laser diode) ¹⁾

¹⁾ At 25 °C.

Performance

Readable code structures	1D codes
Bar code types	All current code types, Code 39, Code 128, Code 93, Codabar, UPC / GTIN / EAN, Interleaved 2 of 5, Pharmacode
Print ratio	2:1 ... 3:1
No. of codes per scan	1 ... 10 (Standard decoder) 1 ... 6 (SMART620)
No. of codes per reading interval	1 ... 50 (auto-discriminating)
No. of characters per reading interval	1,500
No. of multiple readings	1 ... 99

Interfaces

PROFINET	✓
Function	PROFINET Single Port, PROFINET Dual Port
Data transmission rate	2-port Ethernet in accordance with IEEE 802.3 (baud rate 100 MBit/s, full-duplex transmission, 2-port switch, auto-negotiation, auto-crossover). Maximum data length is limited by the mode of communication (fragmentation protocol) to 4,000 bytes.
Digital inputs	2 (1 x "Sensor 1", 1 x via PROFINET Ctrl bits)
Digital outputs	4 (via PROFINET Ctrl bits)
Reading pulse	Non-powered, auto pulse, Fieldbus input, command, Digital input
Optical indicators	5 LEDs
Configuration software	SOPAS ET
Memory card	MicroSD memory card (flash card), optional

Ambient data

Electromagnetic compatibility (EMC)	EN 61000-6-4 (2007-01) + A1 (2011) / EN 61000-6-2:2005-08
Vibration resistance	EN 60068-2-6:2008-02
Shock resistance	EN 60068-2-27:2009-05
Ambient operating temperature	0 °C ... +40 °C
Storage temperature	-20 °C ... +70 °C
Permissible relative humidity	90 %, Non-condensing
Ambient light immunity	2,000 lx, on bar code
Bar code print contrast (PCS)	≥ 60 %

Classifications

ECI@ss 5.0	27280102
ECI@ss 5.1.4	27280102
ECI@ss 6.0	27280102
ECI@ss 6.2	27280102
ECI@ss 7.0	27280102

CLV615-D2540 | CLV61x Dual Port

FIXED MOUNT BAR CODE SCANNERS

ECI@ss 8.0	27280102
ECI@ss 8.1	27280102
ECI@ss 9.0	27280102
ECI@ss 10.0	27280102
ECI@ss 11.0	27280102
ETIM 5.0	EC002550
ETIM 6.0	EC002550
ETIM 7.0	EC002550
ETIM 8.0	EC002550
UNSPSC 16.0901	43211701

Dimensional drawing (Dimensions in mm (inch))

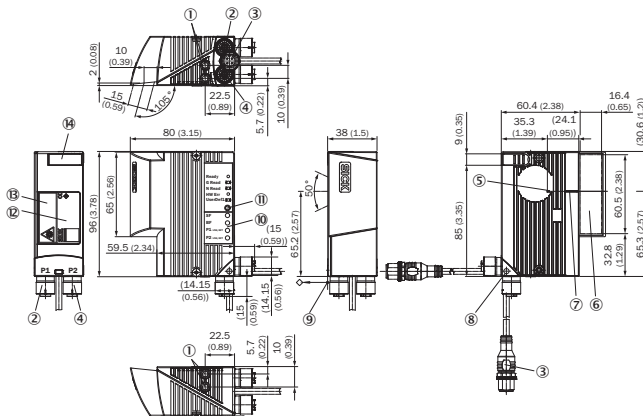



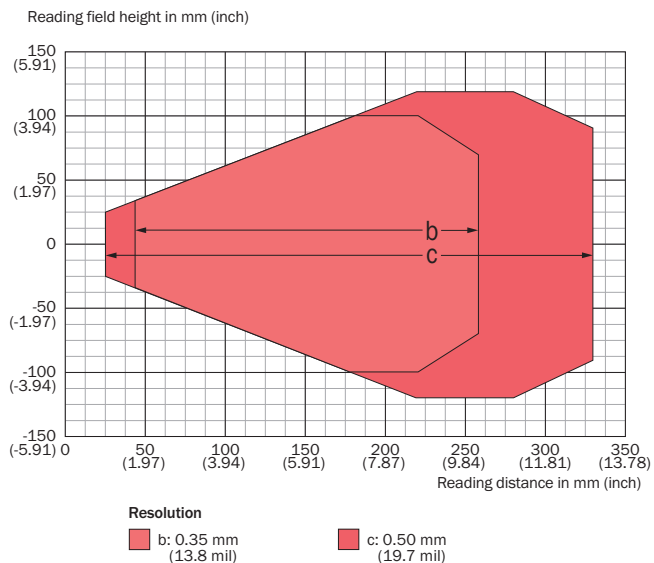

- ① Blind hole thread M5, 5 mm deep (2 x), for mounting
- ② P1 (Port 1) connection, 4-pin M12 female connector, D-coded
- ③ Cable (0.9 m) with POWER connection, 5-pin M12 male connector, A-coded
- ④ P2 (Port 2) connection, 4-pin M12 female connector, D-coded
- ⑤ Internal impact point: rotation point of the variable direction laser beam
- ⑥ Reading window, side orientation
- ⑦ Central position of the deflected laser beam in the V-shaped aperture angle
- ⑧ Swivel connector unit (max 180° rotation angle from end position to end position)
- ⑨ Reference point for reading distance (from housing edge to object)
- ⑩ LED (4 x), status indicator
- ⑪ RGB-LED (1 x), status display with signal color allocation for events
- ⑫ Type label
- ⑬ Laser warning label
- ⑭ Cover for the microSD memory card

Reading field diagram



Recommended accessories

Other models and accessories → www.sick.com/CLV61x_Dual_Port

	Brief description	Type	Part no.
Storage media			
	microSD memory card with 1 GB for industrial use	microSD memory card	4051366
Distributors			
	Male connector M12, 4-pin, straight, A-coded to 2 x female connector M12, 5-pin, straight, A-coded	T-junctions	6058934
Mounting brackets and plates			
	Hanger-shaped mounting bracket, mounting hardware included	Mounting bracket	2042800
Plug connectors and cables			
	Head A: female connector, M12, 4-pin, straight, A-coded Head B: male connector, M12, 4-pin, straight, A-coded Cable: Power, silicone-free, free of paint wetting impairment substances, PUR, shielded, 2 m For connecting a CLV61x Dual Port sensor to a connection chip (part no. 6022472) and flat cable (part no. 6022463)	YX2A24-020UA4F2A24	6060279
	Head A: cable Head B: Flying leads Cable: Power, unshielded For use with connection clip 6022472	ASI-LTGE-MW	6022463

	Brief description	Type	Part no.
	Head A: Connection clip, M12 Cable: Power	ASI-M12	6022472

Recommended services

Additional services → www.sick.com/CLV61x_Dual_Port

	Type	Part no.
Performance check		
<ul style="list-style-type: none"> • Product area: Fixed mount bar code scanners • Range of services: Inspection of defined functions, e.g., reading performance • Travel expenses: The prices do not include travel costs such as hotel, flight, travel time and expenses. • Duration: Additional work will be invoiced separately 	Performance check CLV4xx/CLV6xx	1682028
Product, system, and software training		
<ul style="list-style-type: none"> • Range of services: SICK offers training courses for numerous target groups ranging from basic to expert levels, Training format and location can be worked out in collaboration with SICK 	Training for the CLV6 series	1612231
Warranty extensions		
<ul style="list-style-type: none"> • Product area: Identification solutions, machine vision, Distance sensors, Detection and ranging solutions • Range of services: The services correspond to the scope of the statutory manufacturer warranty (SICK general terms and conditions of purchase) • Duration: Five-year warranty from delivery date. 	Extended warranty for a total of five years from delivery date	1680671
Commissioning		
<ul style="list-style-type: none"> • Product area: Fixed mount bar code scanners • Range of services: Inspection of connection, fine adjustment, optimization of parameters of SICK product as well as tests, Setup of previously defined functions of reading configuration, code configuration, data processing and network, interfaces or inputs and outputs • Travel expenses: The prices do not include travel costs such as hotel, flight, travel time and expenses. • Duration: Additional work will be invoiced separately 	Commissioning CLV61x ... CLV64x	1681925

SICK AT A GLANCE

SICK is one of the leading manufacturers of intelligent sensors and sensor solutions for industrial applications. A unique range of products and services creates the perfect basis for controlling processes securely and efficiently, protecting individuals from accidents and preventing damage to the environment.

We have extensive experience in a wide range of industries and understand their processes and requirements. With intelligent sensors, we can deliver exactly what our customers need. In application centers in Europe, Asia and North America, system solutions are tested and optimized in accordance with customer specifications. All this makes us a reliable supplier and development partner.

Comprehensive services complete our offering: SICK LifeTime Services provide support throughout the machine life cycle and ensure safety and productivity.

For us, that is “Sensor Intelligence.”

WORLDWIDE PRESENCE:

Contacts and other locations –www.sick.com