

THIS COPY IS PROVIDED ON A RESTRICTED BASIS AND IS NOT TO BE USED IN ANY WAY DETRIMENTAL TO THE INTERESTS OF PANDUIT CORP.

NOTES:

1. VISIT OUR ON-LINE CATALOG AT [WWW.PANDUIT.COM](http://WWW.PANDUIT.COM) FOR A LIST OF CURRENT PARTS APPLICABLE FOR USE WITH THIS PRODUCT.
2. PRIMARY DIMENSIONS ARE IN MILLIMETERS.
3. PARTS SUPPLIED:
  - (5) 5RU RIGHT HAND LONG FINGER
  - (5) 5RU LEFT HAND LONG FINGER
  - (3) 8RU RIGHT HAND LONG FINGER
  - (3) 8RU LEFT HAND LONG FINGER
  - (1) INSTALLATION INSTRUCTION (NOT SHOWN)

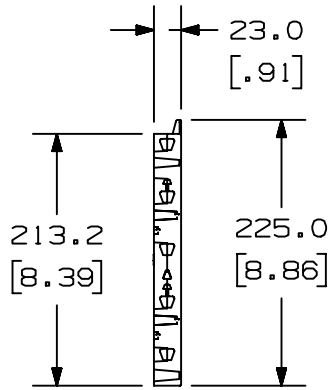
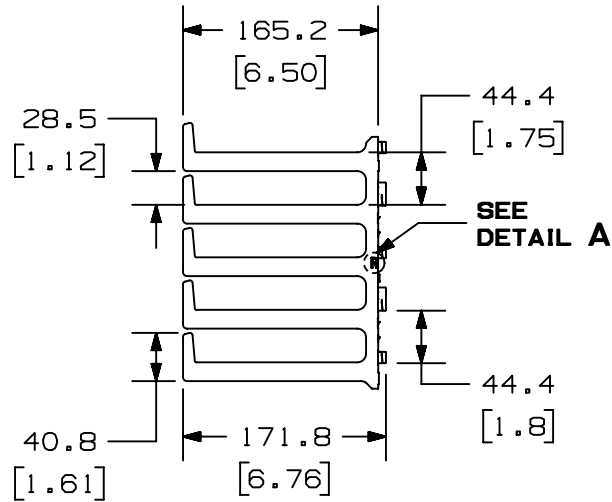
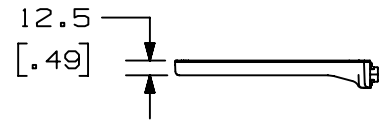

PANDUIT PART NO.	WEIGHT
XG-FML45*	2.2 Kg/EACH 4.95 LBS/EACH

\* DENOTES COLOR  
ADD SUFFIX "B" FOR BLACK  
AND "W" FOR WHITE.

5RU RIGHT HAND  
LONG FINGER



5RU LEFT HAND  
LONG FINGER

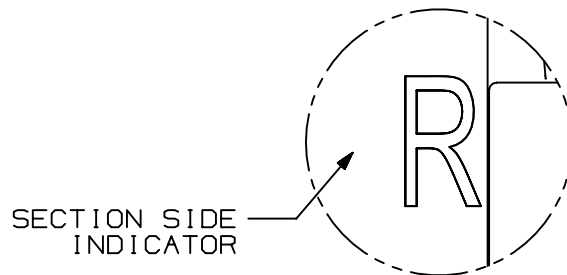
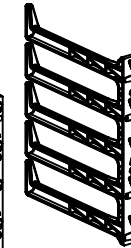

SECTION SIDE  
INDICATOR

DETAIL A  
SCALE 2:1

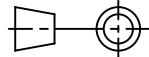
TITLE		FLEXFUSION 42RU-45RU LONG FINGER KIT (XG-FML45B & XG-FML45W)		CUSTOMER DRAWING	
ITEM REVISION NAME		00462EAH/01		<b>PANDUIT</b>	
DATASET FILE NAME		00462EAH_DC/01A			
DRAWING NUMBER:		00462EAH_DC		MATERIAL:	
				N/A	
DRAWN BY		DATE		THIRD ANGLE PROJECTION	
MEX-JAGC		2/22/21			
CHK		SCALE		DRAWING NUMBER:	
EWSA		NONE		00462EAH_DC	
REV		DESCRIPTION		SHT 1 OF 2	
01A		DRAWING RELEASE		A	
DATE		ECN			
2/22/21		V09002ER/07			

XGLOBAL\_ASIZE

THIS COPY IS PROVIDED ON A RESTRICTED BASIS AND IS NOT TO BE USED IN ANY WAY DETRIMENTAL TO THE INTERESTS OF PANDUIT CORP.

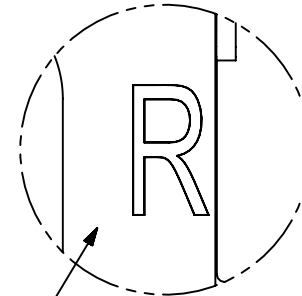
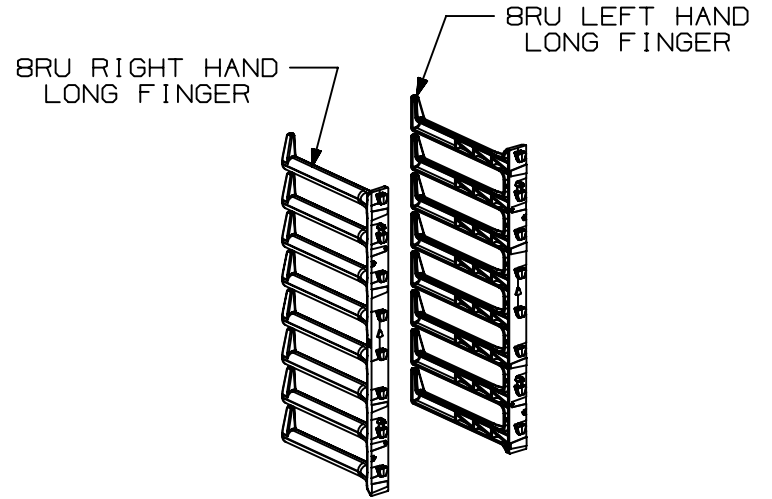
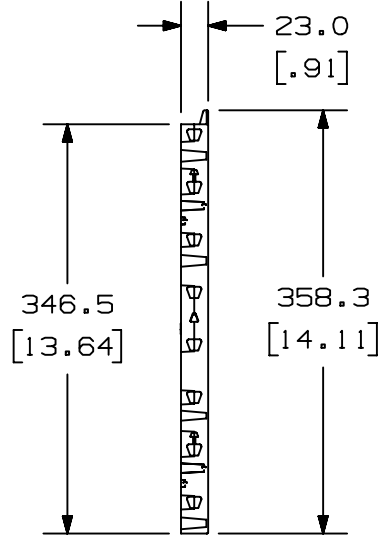
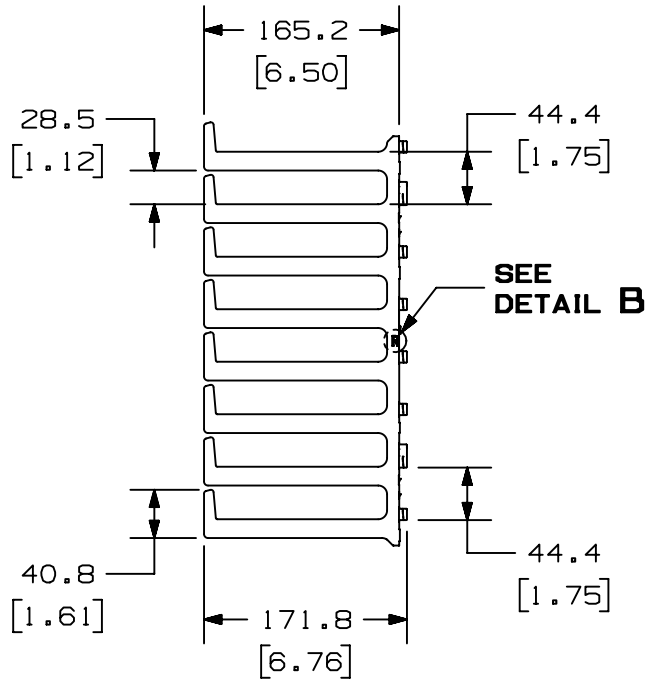
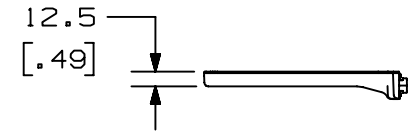

SECTION SIDE INDICATOR

**DETAIL B  
SCALE 2:1**

TITLE		FLEXFUSION 42RU-45RU LONG FINGER KIT (XG-FML45B & XG-FML45W)			CUSTOMER DRAWING	
ITEM REVISION NAME		00462EAH/01			<b>PANDUIT</b>	
DATASET FILE NAME		00462EAH_DC/01A				
MATERIAL		N/A			DRAWING NUMBER: 00462EAH_DC	
DRAWN BY		DATE	CHK	SCALE	THIRD ANGLE PROJECTION	
MEX-JAGC		2/22/21	EWSA	NONE	SHT 2 OF 2	
REV		DATE	BY	CHK	APR	DESCRIPTION
01A		2/22/21	MEX-JAGC	EWSA	ELE	DRAWING RELEASE
						V09002ER/07
REV		DATE	BY	CHK	APR	DESCRIPTION

GLOBAL-ASIZE