

BEF-KHZTS100MPA

**SICK**  
Sensor Intelligence.

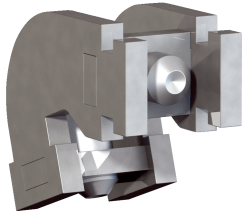

## Ordering information

Type	Part no.
BEF-KHZTS100MPA	2086758

Other models and accessories → [www.sick.com/](http://www.sick.com/)

## Detailed technical data

### Technical specifications

<b>Accessory group</b>	Brackets for cylinder sensors
<b>Accessory family</b>	For SMC cylinders CP96
<b>Material</b>	Stainless steel V2A
<b>Dimensions (W x H x L)</b>	10 mm x 12.9 mm x 14.8 mm
<b>Description</b>	Sensor adapter CP96-100
<b>Usable for</b>	MPA-107 mm ... 251 mm (sensor measuring range), 2 (recommended number of brackets) MPA-287 mm ... 431 mm (measuring range sensor), 3 (recommended number mounting brackets) MPA-467 mm ... 647 mm (measuring range sensor), 4 (recommended number mounting brackets) MPA-683 mm ... 791 mm (measuring range sensor), 5 (recommended number mounting brackets) MPA-827 mm ... 1007 mm (measuring range sensor), 6 (recommended number mounting brackets)

### Classifications

<b>eCl@ss 5.0</b>	27279202
<b>eCl@ss 5.1.4</b>	27279202
<b>eCl@ss 6.0</b>	27279202
<b>eCl@ss 6.2</b>	27279202
<b>eCl@ss 7.0</b>	27279202
<b>eCl@ss 8.0</b>	27279202
<b>eCl@ss 8.1</b>	27279202
<b>eCl@ss 9.0</b>	27273701
<b>eCl@ss 10.0</b>	27273701
<b>eCl@ss 11.0</b>	27273701
<b>eCl@ss 12.0</b>	27273701
<b>ETIM 5.0</b>	EC002024
<b>ETIM 6.0</b>	EC002024
<b>ETIM 7.0</b>	EC002024
<b>ETIM 8.0</b>	EC002024
<b>UNSPSC 16.0901</b>	32131023

Dimensional drawing (Dimensions in mm (inch))

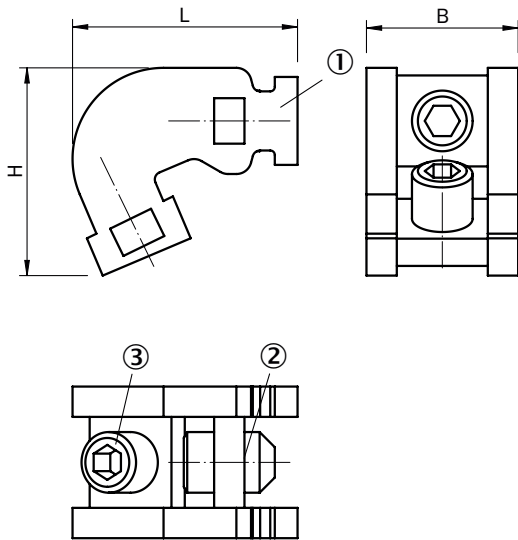

- ① Sensor adapter
- ② Fixing screw SW 2.0 for sensor
- ③ Fixing screw SW 2.0 for cylinder

		<b>L</b>	<b>H</b>	<b>W</b>
2086756	BEF-KHZTS063MPA	12.6	11.7	10
2086757	BEF-KHZTS080MPA	14.8	13.7	10
2086758	BEF-KHZTS100MPA	14.8	12.9	10
2086759	BEF-KHZTS125MPA	14.6	12.2	10

## SICK AT A GLANCE

SICK is one of the leading manufacturers of intelligent sensors and sensor solutions for industrial applications. A unique range of products and services creates the perfect basis for controlling processes securely and efficiently, protecting individuals from accidents and preventing damage to the environment.

We have extensive experience in a wide range of industries and understand their processes and requirements. With intelligent sensors, we can deliver exactly what our customers need. In application centers in Europe, Asia and North America, system solutions are tested and optimized in accordance with customer specifications. All this makes us a reliable supplier and development partner.

Comprehensive services complete our offering: SICK LifeTime Services provide support throughout the machine life cycle and ensure safety and productivity.

For us, that is “Sensor Intelligence.”

## WORLDWIDE PRESENCE:

Contacts and other locations –[www.sick.com](http://www.sick.com)