

CLV630-0120F0

CLV63x

FIXED MOUNT BARCODE SCANNERS

SICK
Sensor Intelligence.



Ordering information

Type	Part no.
CLV630-0120F0	1063470

Other models and accessories → www.sick.com/CLV63x



Detailed technical data

Features

Version	Long Range
Connection type	Ethernet
Reading field	Front
Sensor type	Line scanner
Optical focus	Fixed focus
Light source	Light spot, laser, Visible, Red, 655 nm
Light spot	Circular
Laser class	2 (IEC 60825-1:2014, EN 60825-1:2014)
Aperture angle	≤ 50°
Reading distance	60 mm ... 735 mm ¹⁾
Scanning frequency	400 Hz ... 1,200 Hz
Code resolution	0.35 mm ... 1 mm
Heating	✓
Cold storage applications	✓

¹⁾ For details see reading field diagram.

Mechanics/electronics

Connection type	2 x M12 cylindrical connectors (12-pin male connector, 4-pin female connector) on swivel connector 1 x cable, open-ended, 3-wire (2 m)
Supply voltage	≤ 24 V DC, ± 10 %
Power consumption	40 W
Housing	Aluminum die cast
Housing color	Light blue (RAL 5012)
Window material	Glass

¹⁾ Swivel connector is 15 mm longer.

²⁾ At 25 °C.

Enclosure rating	IP65 (EN 60529)
Protection class	III (EN 61140)
Weight	450 g, without connecting cable
Dimensions (L x W x H)	61 mm x 96 mm x 50 mm ¹⁾
MTBF	100,000 h
MTTF	40,000 h (Laser diode) ²⁾

¹⁾ Swivel connector is 15 mm longer.

²⁾ At 25 °C.

Performance

Readable code structures	1D codes
Bar code types	All current code types
Code printing process	Label (printed codes)
Print ratio	2:1 ... 3:1
No. of codes per scan	1 ... 20 (Standard decoder) 1 ... 6 (SMART decoder)
No. of codes per reading interval	1 ... 50 (auto-discriminating)
No. of characters per reading interval	5,000 500 (for multiplexer function in CAN operation)
No. of multiple readings	1 ... 99

Interfaces

Ethernet	✓, TCP/IP, RS-232, RS-422, RS-485
Type of fieldbus integration	Optional over external fieldbus module CDF600 Optional over external fieldbus module CDF600-2
Function	Data interface (read result output), Service interface PROFINET Single Port, PROFINET Dual Port (optional via external connection module CDF600-2) Data interface (read result output), Service interface SICK CAN sensor network CSN (CAN controller/CAN device, multiplexer/server)
Data transmission rate	10/100 MBit/s 10/100 MBit/s 10/100 MBit/s 2,400 Baud ... 115.2 kBaud, AUX: 57.6 kBaud (RS-232) 20 kbit/s ... 1 Mbit/s 20 kbit/s ... 1 Mbit/s
Digital inputs	3 ("Sensor 1", 2 inputs via optional parameter storage CMC600 in CDB620/CDM420)
Digital outputs	2 (Via optional CMC600 parameter memory in CDB620/CDM420)
Reading pulse	Digital inputs
Optical indicators	6 LEDs (Ready, Result, laser, Data, CAN, LNK TX, Bar graph for displaying the reading rate percentage (10 LEDs))
Acoustic indicators	Beeper/buzzer (can be switched off, can be allocated as a result indication function)
Control elements	2 buttons (choose and start/stop functions)
Configuration software	SOPAS ET
Memory card	MicroSD memory card (flash card), optional

Ambient data

Electromagnetic compatibility (EMC)	EN 61000-6-3 (2001-10) / EN 61000-6-2:2005
Vibration resistance	EN 60068-2-6 (1995)

Shock resistance	EN 60068-2-27 (1993)
Ambient operating temperature	-35 °C ... +35 °C
Storage temperature	-20 °C ... +70 °C
Permissible relative humidity	90 %, Non-condensing
Ambient light immunity	2,000 lx, on barcode
Bar code print contrast (PCS)	≥ 60 %

Classifications

ECLASS 5.0	27280102
ECLASS 5.1.4	27280102
ECLASS 6.0	27280102
ECLASS 6.2	27280102
ECLASS 7.0	27280102
ECLASS 8.0	27280102
ECLASS 8.1	27280102
ECLASS 9.0	27280102
ECLASS 10.0	27280102
ECLASS 11.0	27280102
ECLASS 12.0	27280102
ETIM 5.0	EC002550
ETIM 6.0	EC002550
ETIM 7.0	EC002550
ETIM 8.0	EC002550
UNSPSC 16.0901	43211701

Dimensional drawing (Dimensions in mm (inch))

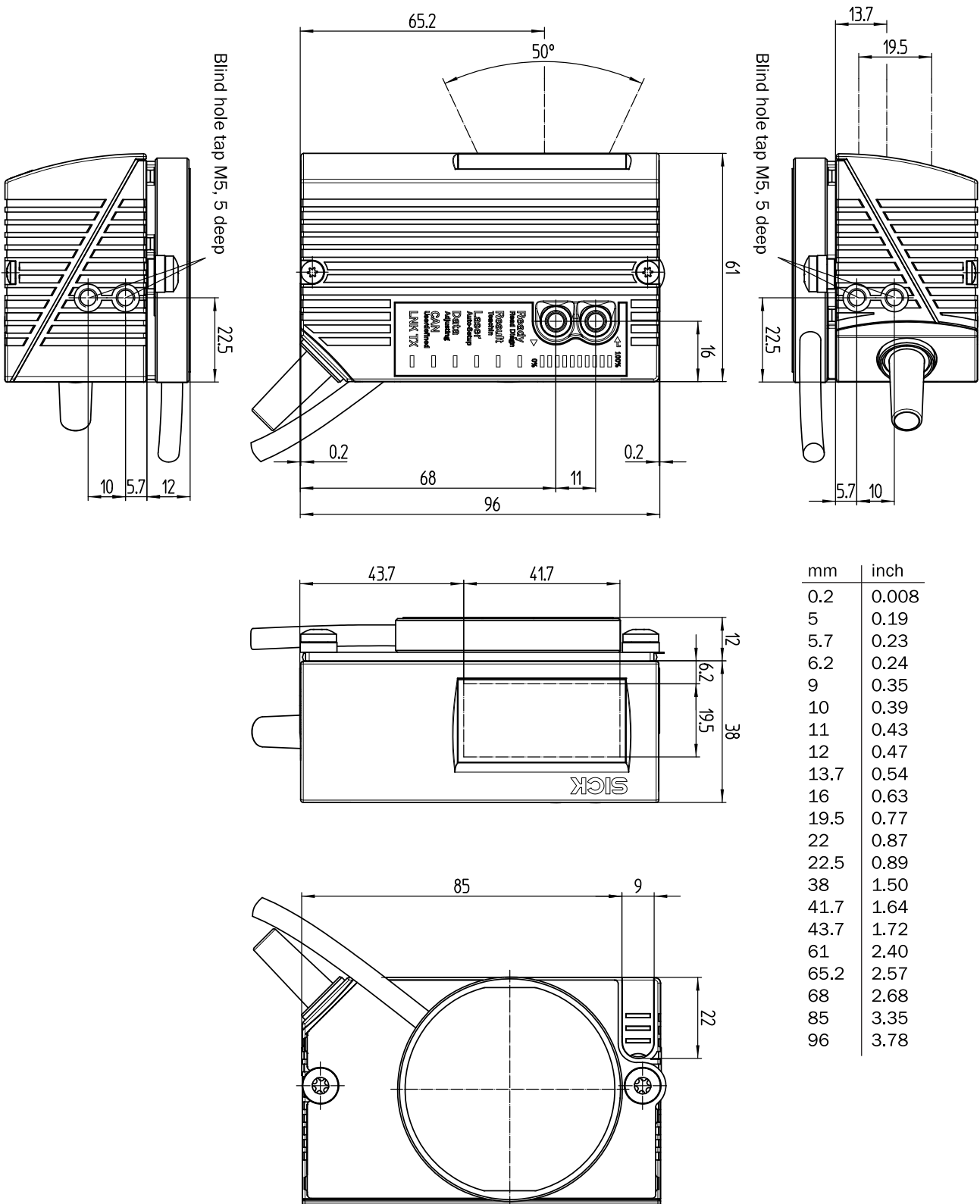

Reading field diagram

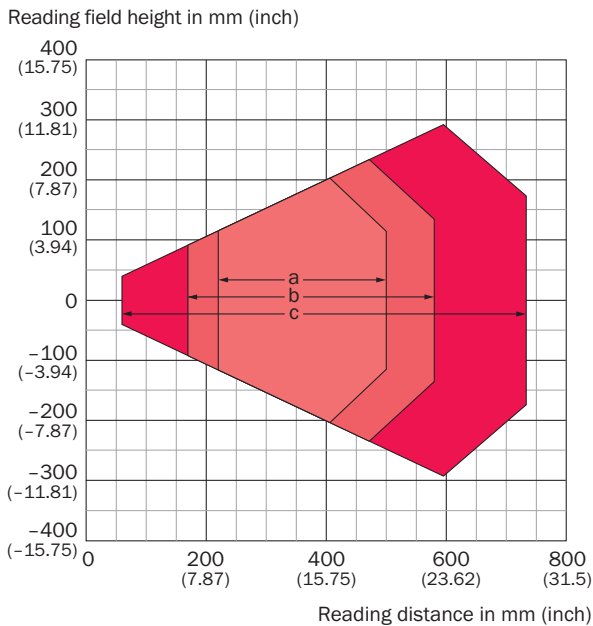





For devices with plastic reading window, the depth of field is reduced by approx. 10 %.



Resolution

- a: 0.35 mm (13.8 mil)
- b: 0.50 mm (19.7 mil)
- c: 1.0 mm (39.4 mil)

Recommended accessories

Other models and accessories → www.sick.com/CLV63x

	Brief description	Type	Part no.
Cloning modules			
	External parameter memory for integration in CDB620/CDB650/CDM42x	CMC600-101	1042259
Electronic modules			
	Additional board for connecting a bar code scanner with heater in combination with CDM-420	Additional board	2055071
Storage media			
	microSD memory card with 1 GB for industrial use	microSD memory card	4051366
Mounting brackets and plates			
	Hanger-shaped mounting bracket, thermally isolated for use with heating devices, mounting hardware included	Mounting bracket	2050705

	Brief description	Type	Part no.
Plug connectors and cables			
	<ul style="list-style-type: none"> • Connection type head A: Male connector, M12, 4-pin, straight, D-coded • Connection type head B: Male connector, RJ45, 8-pin, straight • Signal type: Ethernet • Cable: 2 m, 4-wire, AWG26 • Description: Ethernet, shielded 	YM2D24-020EB2MRJA4	6050198
Modules			
	<ul style="list-style-type: none"> • Sub product family: CDB620 • Supported products: CLV61x - CLV65x, Lector62x, RFH6xx, RFU62x • Brief description: Small connection module for one sensor, 4 cable glands, base for CMC600 	CDB620-001	1042256
	<ul style="list-style-type: none"> • Sub product family: CDM420 • Fieldbus interface: PROFIBUS DP, Ethernet, DeviceNet™ • Supported products: Lector62x, CLV61x - CLV65x, Mobile handheld scanners, RFH6xx, RFU62x, RFU63x • Brief description: Modular connection module for one sensor 	CDM420-0001	1025362

Recommended services

Additional services → www.sick.com/CLV63x

	Type	Part no.
Performance check		
<ul style="list-style-type: none"> • Product area: Fixed mount barcode scanners • Range of services: Inspection of defined functions, e.g., reading performance • Travel expenses: The prices do not include travel costs such as hotel, flight, travel time and expenses. • Duration: Additional work will be invoiced separately 	Performance check CLV4xx/CLV6xx	1682028
Commissioning		
<ul style="list-style-type: none"> • Product area: Fixed mount barcode scanners • Range of services: Inspection of connection, fine adjustment, optimization of parameters of SICK product as well as tests, Setup of previously defined functions of reading configuration, code configuration, data processing and network, interfaces or inputs and outputs • Travel expenses: The prices do not include travel costs such as hotel, flight, travel time and expenses. • Duration: Additional work will be invoiced separately 	Commissioning CLV61x ... CLV64x	1681925
Extended warranty		
<ul style="list-style-type: none"> • Product area: Identification solutions, machine vision, Detection and ranging solutions, safety camera sensors, Safety laser scanners, Safety radar sensors • Range of services: The services correspond to the scope of the statutory manufacturer warranty (SICK general terms of delivery). • Duration: Five-year warranty from delivery date. 	Extended warranty for a total of five years from delivery date	1680671

SICK AT A GLANCE

SICK is one of the leading manufacturers of intelligent sensors and sensor solutions for industrial applications. A unique range of products and services creates the perfect basis for controlling processes securely and efficiently, protecting individuals from accidents and preventing damage to the environment.

We have extensive experience in a wide range of industries and understand their processes and requirements. With intelligent sensors, we can deliver exactly what our customers need. In application centers in Europe, Asia and North America, system solutions are tested and optimized in accordance with customer specifications. All this makes us a reliable supplier and development partner.

Comprehensive services complete our offering: SICK LifeTime Services provide support throughout the machine life cycle and ensure safety and productivity.

For us, that is “Sensor Intelligence.”

WORLDWIDE PRESENCE:

Contacts and other locations –www.sick.com