



Product designation				Enclosed switch disconnecter
Product type designation				GAZM
Number of poles		Nr.		3
Operating voltage type				AC
Contact characteristics				
IEC Conventional free air thermal current I _{th}		A		32
Rated insulation voltage U _i IEC/EN		V		1000
Rated impulse withstand voltage U _{imp}		kV		8
Operating current I _e				
AC21A				
	400V	A		32
	500V	A		32
	690V	A		32
AC22A				
	400V	A		32
	500V	A		32
	690V	A		32
AC23A				
	400V	A		32
	500V	A		25
	690V	A		25
Power dissipation per pole max		W		0.6
Rated operational power AC23A				
	400V	kW		15
	690V	kW		22
Conditional short-circuit current (rms)		kA		10
Short-circuit protection with fuse		Class/A		gG32
Making capacity AC23A 400V		A		400
Breaking capacity AC23A 400V		A		320
Mechanical life		cycles		100000
Electrical life AC21A		cycles		100000
Mechanical features				
Operating position		normal allowable		Vertical plan Any
Terminals				
		type		Pillar
		width	mm	5.6
		height	mm	6.5
		screw		M4
		tool		Phillips 2
Tightening torque for terminals				
		min	Nm	1.8
		max	Nm	2

	min	lbin	16
	max	lbin	18

Conductor section	IEC min	mm ²	0.75
	IEC max	mm ²	16
	AWG/kcmil min		18
	AWG/kcmil max		6

Ambient conditions

Operating temperature	min	°C	-25
	max	°C	+55

Storage temperature	min	°C	-40
	max	°C	+70

Max altitude	m	3000
--------------	---	------

Resistance & Protection

Frontal IP degree	IP65
-------------------	------

IP degree of protection	IP65
-------------------------	------

Pollution degree	3
------------------	---

Dimensions

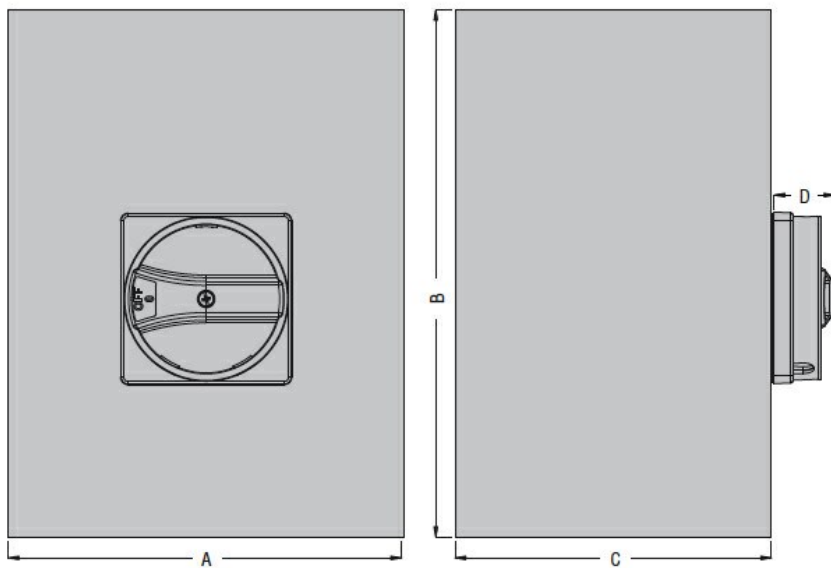

Type	A	B	C	D
GAZM016...GAZM100...	150 (5.90")	200 (7.87")	120 (4.72")	23 (0.90")

Wiring diagrams

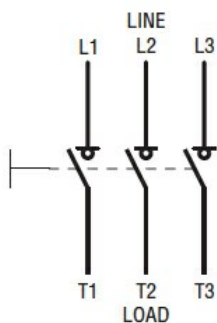

Certifications and compliance

Compliance

IEC/EN 60947-1
IEC/EN 60947-3

ETIM classification

ETIM 8.0

EC000216 -
Switch
disconnecter