

Central Article Code: D06120W03-A

ETN Code or Other: 710 015 115

Created: 06/09/2005

Modified: 10/07/2009

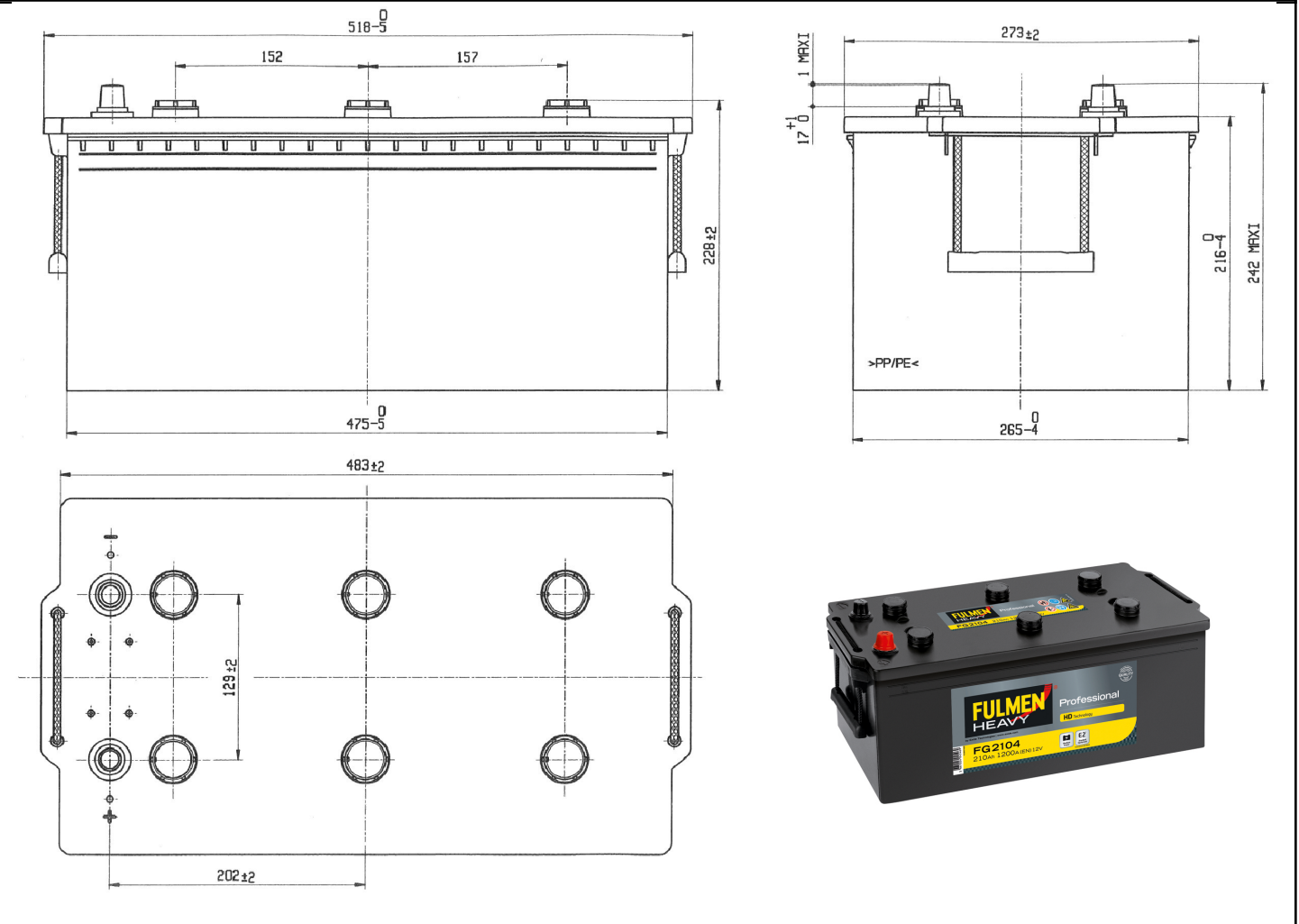

PERFORMANCES		CONTAINER	
Voltage (V):	12 V	Type:	D06 BLACK
C20 (Ah):	210.0 20 h	Hold Down:	B0
Rc (min):	0	H. D. Adapter:	No
Cranking (A):	1200 EN	COVER	
Vibration:	V2 (35Hz/6g/2h)	Type:	Flat/Screw BLACK
Endurance:	E2 (90 cycles@50%)	Polarity:	ETN 4
Charge:	WET	Terminals:	EN taper post
Technology:	Vented/Flooded	Terminal Adapter:	No
Grid :	Hybrid	SOCI:	No
WEIGHT AND STD. DIMENSIONS		Ventilation:	Independent
Battery Weight (kg):	56.64	Filter:	No
Volume acid (l):	16.64	Lateral Plug:	No
Length (mm):	518	PLUGS	
Width (mm):	279	Type:	6 x M27 BLACK
Height (mm):	240	HANDLES	
		Type:	2 x Rope (Rigid holder) BLACK
		OTHERS	
		Degassing Tube:	No