



Product designation

Adjustable roller
lever

Product type designation

KBF

General characteristics

Material

Housing
Roller

Polymer
thermoplastic
Rubber

Contact characteristics

Type of contact

1NO+1NC Slow
action

Thermal current I_{th}

A 10

IEC/EN 60947-5-1 designation

A600 Q300

Rated insulation voltage U_i

V 690

Rated impulse withstand voltage U_{imp}

kV 6

Insulation class

II

Short-circuit protection with fuse

Class/A 10 gG/SC
QUICK FUSE

Switching speed

min	m/s	0.5
max	m/s	1.5

IEC Conventional free air thermal current I_{th}

A 10

Resistance per pole (average value)

mΩ <10

Mechanical features

Operating head fixing

Locking bayonet
insert

Operating torque

Ncm	3
ozin	4.25

Tightening torque (Max)

Switch fixing

Nm	2.5
lbin	22.1

Contact terminals

Nm	0.8
lbin	7

Body lid screw fixing

Nm	0.8
lbin	7

Conductor section

AWG/Kcmil

min	16
max	14

IEC

min	mm ²	1or 2
max	mm ²	2.5

Cable connection	Self-releasing screw terminal
Cable entry	M20 on the bottom

Operations	
Mechanical life	cycles <10000000
Mechanical operation	cycles/h 3600

Ambient conditions	
Temperature	
Operating temperature	
min	°C -25
max	°C +70
Storage temperature	
min	°C -40
max	°C +70

Resistance & Protection	
IP degree	
Terminals	IP20
Body housing	IP65
Pollution degree	3

Dimensions

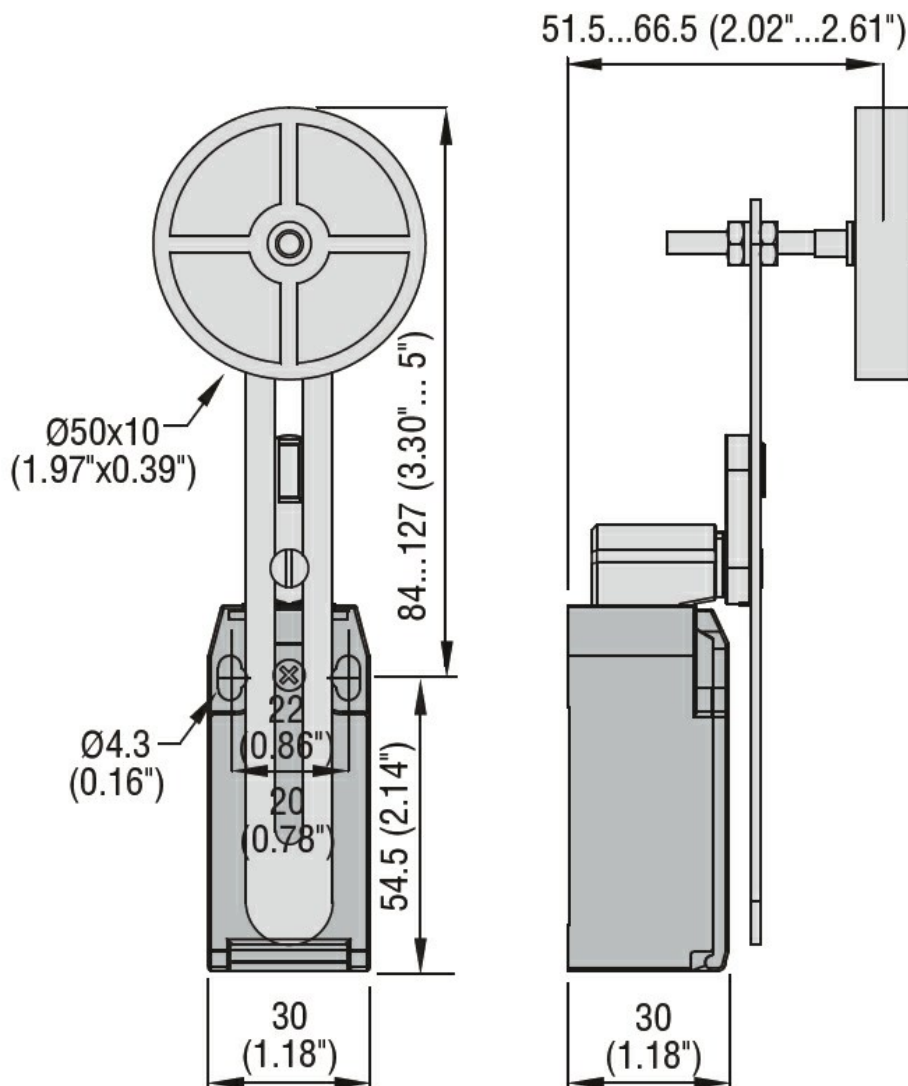

Wiring diagrams

Slow action

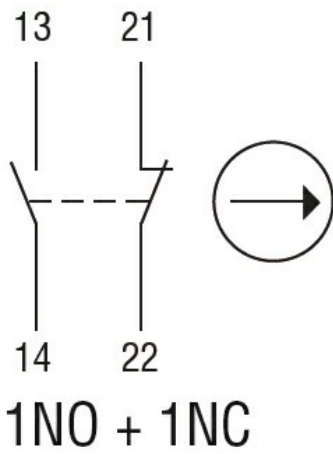

Certifications and compliance

Compliance

CSA C22.2 n° 14

EN 50047

IEC/EN 60204-1

IEC/EN 60947-1

IEC/EN 60947-5-1

UL508

Certificates

CCC

cULus

EAC

ETIM classification

ETIM 8.0

EC000030 - End
switch