



CDVI

EN ENGLISH

FR FRANCAIS

VIRA20245048

VIRA2048

VIRA5024

VIRP20245048

VIRP2048

VIRP5024

VIE20245048

VIE2048

VIE5024

Firedoor Electromagnetic door retainers
Ventouses pour porte coupe-feu

EN 1155 : 1997 + A1 : 2002

CE 0526



VIRA

VIE

VIRP

The installer's choice
cdvigroup.com

VIRA - VIRP - VIE RANGE

Firedoor Electromagnetic door retainers

Thank you for buying our products and for the confidence you placed in our company.

1] PRODUCT PRESENTATION

- **In case of fire, the door is released.**
- **Fail-safe.**
- **Built-in red push button to release the door manually (or for test purposes).**
- **Floor mounted or Wall mounted*.**
- **Supplied with a universal armature.**
- **Holding force: 20 to 50kg*.**

- Extreme reliability, no mechanical parts subject to wear.
- Integrated electronic protection.
- Easy installation.
- No residual magnetism.
- Silent operation.
- Power supply: 24V or 48V*.
- Consumption: 20mA to 80mA*.
- Force 3 to 7.

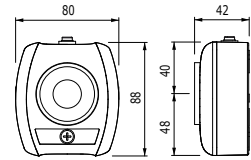

VIRA RANGE

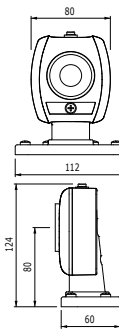

VIRP RANGE

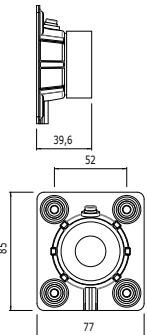

VIE RANGE

Certificat n° 0526-CPD-H09004
Certified products : Electromagnetic door retainers
Standardized classification : 3 5 3/7 1 1 4
Reference standard : EN 1155 : 1997 + A1 : 2002

The Declaration of Performance is available on our website : www.cdvi.com

	Holding force	Power supply	Consumption
VIRA20245048	20/50 Kg	24/48Vdc	24/48 mA
VIRA2048	20 Kg	48 Vdc	24 mA
VIRA5024	50 Kg	24 Vdc	80 mA
VIRP20245048	20/50 Kg	24/48Vdc	24/48 mA
VIRP2048	20 Kg	48 Vdc	24 mA
VIRP5024	50 Kg	24 Vdc	80 mA
VIE20245048	20/50 Kg	24/48Vdc	24/48 mA
VIE2048	20 Kg	48 Vdc	24 mA
VIE5024	50 Kg	24 Vdc	80 mA

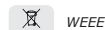

WEEE



IP42



RoHS



EC certification

Recommended power supplies



ARD24



BS24

* Depending on the version.

VIRA - VIRP - VIE RANGE

Firedoor Electromagnetic door retainers

2] REMINDERS AND RECOMMENDATIONS

The function of electromagnetic door retainers is to ensure the integrity of a fire door. This document is a guide of installation which will allow you to complete the installation according to the characteristics of the product, the site and the environmental requirements.

APPROVAL RELATIVE TO EMERGENCY EXITS:

In the case of an installation of fire door electromagnetic door retainers on emergency exits, it is imperative to make sure that these exit points will be automatically free in case of fire alarm, to open in the event of a fire alarm to allow evacuation of the premises. The fire door electromagnetic door retainers installed on emergency exits must be in accordance with the fire approval department.

POWER SUPPLY

A fire door electromagnetic door retainer always operates in DC current, a very low safety voltage. fire door electromagnetic door retainers are recommended for use with power supplies manufactured by CDVI, however, other power supplies may be used on condition that they are of equivalent quality and characteristics rectified, filtered, regulated and protected by fuse in primary and secondary sectors.





MOUNTING RECOMMENDATIONS

- Define the level of security of the access.
- Determine the maximum strength of holding force to this level of security.
- Select the fire door electromagnetic door retainer according to the environment.
- Indeed make sure that the frame and opening, receiving or supporting the fire door electromagnetic door retainer, armature plate and their accessories, are solid and resistant to damage or wear over a period of time.
- Define the passage of cables to ensure the protection against the vandalism and the environmental requirements (in particular through flexible hoses of door, glands, gutters, cross cables, plastic tubes).

MAINTENANCE

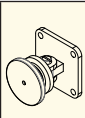
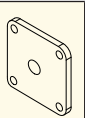
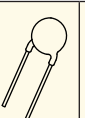
The Electro magnet and armature plate have a specific treatment which strengthens the protection against wear and corrosion. These products do not require high maintenance. Nevertheless to ensure optimum performance, it is recommended to clean regularly the surfaces in contact of the electro magnet and armature plate with a cloth and non abrasive products. If traces of corrosion appear, it is recommended to clean and oil the contact surfaces. Check and tighten regularly all the fixings of the Electro magnet and ensure that while the armature is able to pivot on its mounting, the fixing bolt is not liable to loosen (we recommend thread-lock for all fixing bolts).

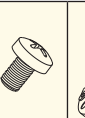
3] PACKAGE CONTENTS

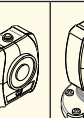
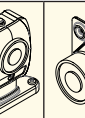
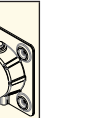
										
	Armature plate	Fixed armature plate	Varistor	Label	M5 screw	Floor fixing plate	Installation manual	Magnetic door retainer	Magnetic door retainer	Magnetic door retainer
VIRA RANGE	1	1	1	1	-	-	1	1	-	-
VIRP RANGE	1	1	1	1	4	1	1	-	1	-
VIE RANGE	1	-	1	-	-	-	1	-	-	1

* For more information, contact CDVI, the local fire officer or the safety officer responsible for the building.

VIRA - VIRP - VIE RANGE

Firedoor Electromagnetic door retainers

4] ELECTRICAL CONNECTIONS

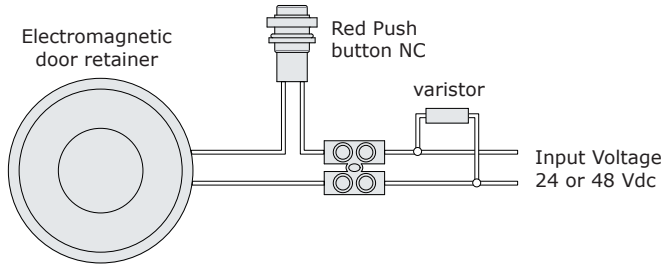

5] INSTALLATION

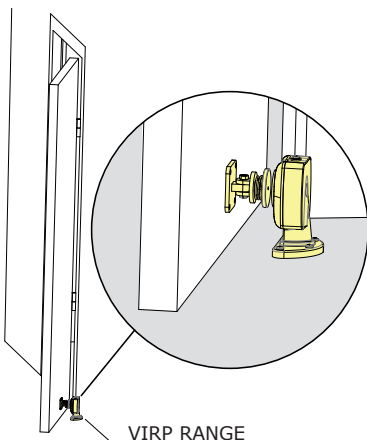
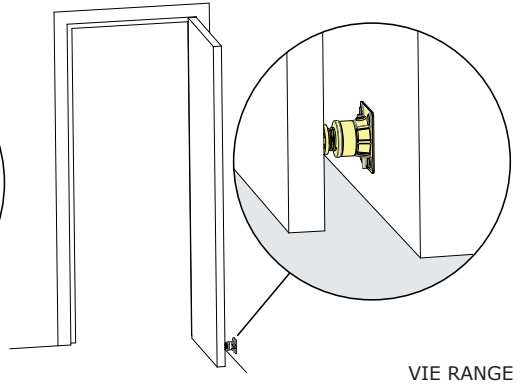
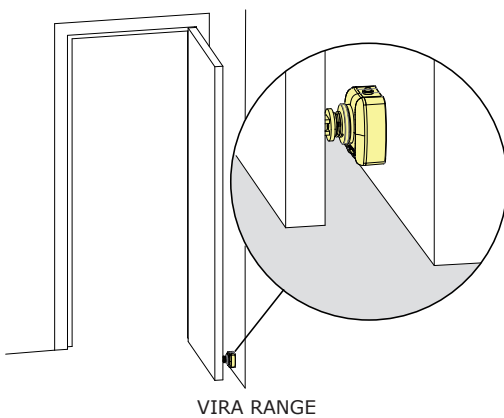

General instructions:

- The door retaining magnet must be mounted on the wall or floor.
- The armature plate is mounted on the door leaf. Ensure both parts are aligned correctly.
- The door must have a reliable door closer.
- Install the magnet and armature.
- Connect the power to the magnet and verify that the magnet holds the armature plate/door securely.
- Remove the power, or push the red test button, to ensure the magnet releases the armature, and allows the door to freely close via the door closer.
- The power to apply to release the door from the door holder has to be minimum 40 Nm in case of switch-off button visible and accessible, whatever the force applied by the door closer, in accordance with EN1155 regulation. In case of non-accessible switch-off button or non-existing one, the power to apply to release the door from the door holder, whatever the force applied by the door closer, must be between 40 and 120Nm, in accordance with the EN1155 regulation.

GAMME VIRA - VIRP - VIE

Ventouses pour porte coupe-feu

Merci pour l'achat de ce produit et pour la confiance que vous accordez à notre entreprise.

1] PRÉSENTATION PRODUIT

- En cas d'incendie, le dispositif libère la porte par rupture de courant.
- Rupture.
- Bouton poussoir rouge pour la dé-condamnation de proximité.
- Avec pied ou sans pied.
- Livrée avec une contre-plaque (fixe et/ou articulée).
- Force de rétention de 20 à 50 kg*.

- Fiabilité extrême, aucune pièce mécanique ne peut s'user.
- Protections électroniques intégrées.
- Facilité d'installation.
- Pas de magnétisme résiduel.
- Fonctionnement silencieux.
- Auto-alignement
- Alimentations : 24 V ou 48 V*.
- Consommation : de 20 mA à 80 mA*.
- Force 3 à 7.

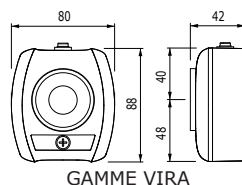

GAMME VIRA

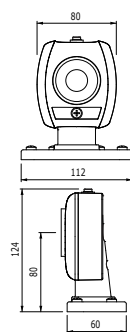

GAMME VIRP

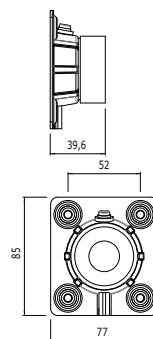

GAMME VIE

Certificat n° 0526-CPD-H09004
Produits certifiés : Dispositif de retenue électromagnétique pour porte
Classification normalisée : 3 5 3/7 1 1 4
Norme de référence : EN 1155 : 1997 + A1 : 2002

La déclaration de performance est disponible sur notre site web : www.cdvi.com

	Force de rétention	Alimentation	consommation
VIRA20245048	20/50 Kg	24/48 Vdc	24/48 mA
VIRA2048	20 Kg	48 Vdc	24 mA
VIRA5024	50 Kg	24 Vdc	80 mA
VIRP20245048	20/50 Kg	24/48 Vdc	24/48 mA
VIRP2048	20 Kg	48 Vdc	24 mA
VIRP5024	50 Kg	24 Vdc	80 mA
VIE20245048	20/50 Kg	24/48 Vdc	24/48 mA
VIE2048	20 Kg	48 Vdc	24 mA
VIE5024	50 Kg	24 Vdc	80 mA

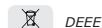

Alimentations préconisées

ARD24 BS24

* Selon version.

GAMME VIRA - VIRP - VIE

Ventouses pour porte coupe-feu

2] RAPPELS ET RECOMMANDATIONS

Ce document est un guide de pose qui vous permettra de sécuriser l'installation en fonction des caractéristiques du produit, du site et des contraintes environnementales.

NORME INCENDIE RELATIVE AUX ISSUES DE SECOURS

Dans le cas d'une installation de ventouses électromagnétiques sur des issues de secours, il est impératif de s'évacuer que ces accès seront automatiquement libres en cas d'alarme incendie, pour permettre une évacuation des lieux. Les ventouses électromagnétiques installées sur des issues de secours doivent impérativement être conforme à la norme incendie locale.

ALIMENTATION

Une ventouse électromagnétique fonctionne toujours en courant continu, impérativement en très basse tension de sécurité (TBTS). Nos ventouses électromagnétiques sont préconisées avec les alimentations de la gamme CDVI, toutefois, d'autres alimentations peuvent être utilisées à la condition que celles-ci présentent une qualité et des caractéristiques équivalentes, notamment redressée, filtrée, régulée, protégé par fusible en primaire et secondaire.







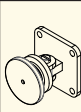
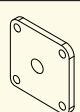

CONSEIL D'INSTALLATION

- Définir le niveau de sécurité de l'accès.
- Adapter la force de rétention maximum à ce niveau de sécurité.
- Sélectionner la ventouse électromagnétique en fonction de l'environnement.
- Bien s'assurer que le dormant et l'ouvrant, recevant ou supportant la ventouse, la contre-plaque et leurs accessoires, soient solides et résistants dans le temps.
- Adapter les éléments de montage en fonction du type support recevant la ventouse et la contreplaque (visserie, chevilles, accessoires,...).
- Définir le passage des câbles pour en assurer la protection contre le vandalisme et les contraintes environnementales (notamment par l'intermédiaire de flexibles de porte, presse-étoupe, goulottes, passe câbles, tubes plastiques, ...).

ENTRETIEN

La ventouse et sa contreplaque disposent d'un revêtement spécifique qui renforce la protection contre l'usure et la corrosion. Ces produits nécessitent donc peu d'entretien. Néanmoins pour assurer une fonctionnalité optimum, il est recommandé de nettoyer régulièrement les surfaces en contact de la ventouse et de sa contreplaque avec un chiffon et produits non abrasifs. Si des traces de corrosion venaient à apparaître, il est recommandé de nettoyer et huiler légèrement ces mêmes surfaces en contact. Vérifier et resserrer régulièrement l'ensemble des fixations de la ventouse. Il est nécessaire de mettre un frein-filet sur la vis pivot de la contreplaque.

3] ÉLÉMENTS FOURNIS

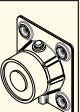
										
	Contre-plaque articulée	Contre-plaque fixe	Varistance	Etiquette	Vis M5	Plaque de fixation au sol	Notice	Ventouse VIRA	Ventouse VIRP	Ventouse VIE
GAMME VIRA	1	1	1	1	-	-	1	1	-	-
GAMME VIRP	1	1	1	1	4	1	1	-	1	-
GAMME VIE	1	-	1	-	-	-	1	-	-	1

* Pour plus d'informations, rapprochez-vous de CDVI, de l'organisme certifié local ou du centre de sécurité du bâtiment.

GAMME VIRA - VIRP - VIE

Ventouses pour porte coupe-feu

4] RACCORDEMENT

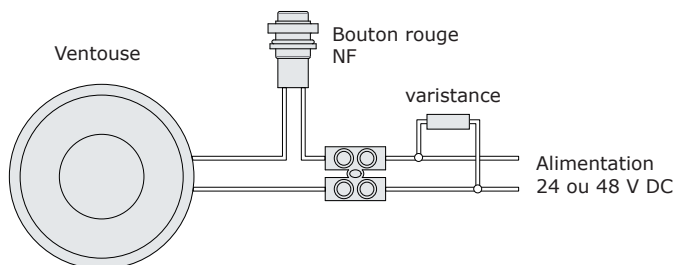

5] INSTALLATION

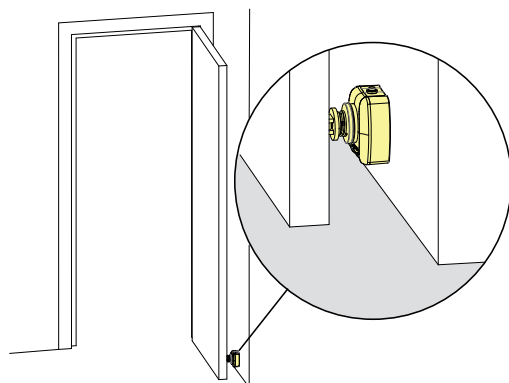

GAMME VIRA

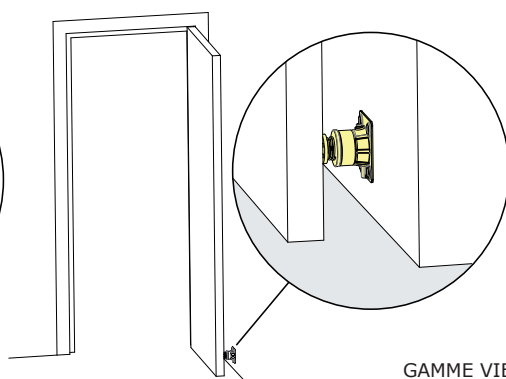

GAMME VIE

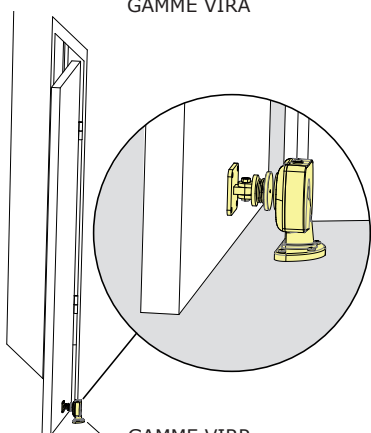

GAMME VIRP

Instructions :

- La ventouse de rétention peut être installée en partie haute ou basse.
- La ventouse se fixe sur le mur et la contre-plaque sur la porte.
- S'assurer du bon alignement de la ventouse et de sa contre-plaque.
- La porte doit être équipée d'un ferme-porte
- Après avoir alimenté la ventouse, vérifier le bon fonctionnement de l'ensemble.
- Quelle que soit la force du ferme-porte, s'assurer que la force d'arrachement nécessaire au déclenchement manuel de la porte est :
 1. Supérieure à 40 Nm, lorsque la ventouse est équipée d'un bouton de dé-condamnation accessible, au regard de la norme EN1155.
 2. Comprise entre 40 et 120 Nm lorsque la ventouse n'est pas équipée d'un bouton de dé-condamnation ou que celui-ci est inaccessible, au regard de la norme EN1155.



CDVI Group

FRANCE (Headquarter/Siège social)
31, avenue du Général Leclerc
93500 Pantin - France
Phone: +33 (0)1 48 91 01 02
Fax: +33 (0)1 48 91 21 21

CDVI

FRANCE + EXPORT
Phone: +33 (0)1 48 91 01 02
Fax: +33 (0)1 48 91 21 21

CDVI AMERICAS

[CANADA - USA]
Phone: +1 (450) 682 7945
Fax: +1 (450) 682 9590

CDVI

BENELUX
[BELGIUM - NETHERLAND - LUXEMBOURG]
Phone: +32 (0) 56 73 93 00
Fax: +32 (0) 56 73 93 05

CDVI

TAIWAN
Phone: +886 (0)42471 2188
Fax: +886 (0)42471 2131

CDVI

SUISSE
Phone: +41 (0)21 882 18 41
Fax: +41 (0)21 882 18 42

CDVI

CHINA
Phone: +86 (0)10 84606132/82
Fax: +86 (0)10 84606182

CDVI

IBÉRICA
[SPAIN - PORTUGAL]
Phone: +34 (0)935 390 966
Fax: +34 (0)935 390 970

CDVI

ITALIA
Phone: +39 0321 90 573
Fax: +39 335 127 89 96

CDVI

MAROC
Phone: +212 (0)5 22 48 09 40
Fax: +212 (0)5 22 48 34 69

CDVI

SWEDEN
[SWEDEN - DENMARK - NORWAY - FINLAND]
Phone: +46 (0)31 760 19 30
Fax: +46 (0)31 748 09 30

CDVI

UK
[UNITED KINGDOM - IRELAND]
Phone: +44 (0)1628 531300
Fax: +44 (0)1628 531003

All the information contained within this document (pictures, drawing, features, specifications and dimensions) could be perceptibly different and can be changed without prior notice.
Toutes les informations mentionnées à titre indicatif sur le présent document (photos, dessins, caractéristiques techniques et dimensions) peuvent varier et sont susceptibles de modifications sans notification préalable.