



# WSE9M4-3P2230

W9

SMALL PHOTOELECTRIC SENSORS

**SICK**  
Sensor Intelligence.



Illustration may differ



### Ordering information

Type	Part no.
WSE9M4-3P2230	1051912

Other models and accessories → [www.sick.com/W9](http://www.sick.com/W9)

### Detailed technical data

#### Features

<b>Functional principle</b>	Through-beam photoelectric sensor
<b>Dimensions (W x H x D)</b>	12.2 mm x 49.8 mm x 23.6 mm
<b>Housing design (light emission)</b>	Rectangular
<b>Mounting hole</b>	M4
<b>Sensing range max.</b>	0 m ... 10 m
<b>Sensing range</b>	0 m ... 7 m
<b>Type of light</b>	Visible red light
<b>Light source</b>	PinPoint LED <sup>1)</sup>
<b>Light spot size (distance)</b>	Ø 25 mm (1 m)
<b>Wave length</b>	650 nm
<b>Adjustment</b>	None

<sup>1)</sup> Average service life: 100,000 h at T<sub>U</sub> = +25 °C.

## Mechanics/electronics

<b>Supply voltage <math>U_B</math></b>	10 V DC ... 30 V DC <sup>1)</sup>
<b>Ripple</b>	< 5 V <sub>pp</sub> <sup>2)</sup>
<b>Current consumption</b>	30 mA <sup>3)</sup>
<b>Switching output</b>	PNP <sup>4)</sup>
<b>Switching mode</b>	Light/dark switching <sup>4)</sup>
<b>Output current <math>I_{max}</math></b>	≤ 100 mA <sup>5)</sup>
<b>Response time</b>	< 0.5 ms <sup>6)</sup>
<b>Switching frequency</b>	1,000 Hz <sup>7)</sup>
<b>Connection type</b>	Male connector M8, 4-pin
<b>Circuit protection</b>	A <sup>8)</sup> B <sup>9)</sup> C <sup>10)</sup>
<b>Protection class</b>	III
<b>Weight</b>	13 g
<b>Housing material</b>	Plastic, VISTAL®
<b>Optics material</b>	Plastic, PMMA
<b>Enclosure rating</b>	IP66 IP67 IP69K
<b>Test input sender off</b>	Sender off
<b>Ambient operating temperature</b>	-40 °C ... +60 °C
<b>Ambient temperature, storage</b>	-40 °C ... +75 °C
<b>UL File No.</b>	NRKH.E181493
<b>Part number of individual components</b>	2057938 WS9M4-3D2230 2057939 WE9M4-3P2230

<sup>1)</sup> Limit values when operated in short-circuit protected network: max. 8 A.

<sup>2)</sup> May not exceed or fall below  $U_V$  tolerances.

<sup>3)</sup> Without load.

<sup>4)</sup> Q = light switching.

<sup>5)</sup> At and above  $T_u$  50 °C, a max. load current of  $I_{max} = 50$  mA is permitted.

<sup>6)</sup> Signal transit time with resistive load.

<sup>7)</sup> With light/dark ratio 1:1.

<sup>8)</sup> A =  $V_S$  connections reverse-polarity protected.

<sup>9)</sup> B = inputs and output reverse-polarity protected.

<sup>10)</sup> C = interference suppression.

## Safety-related parameters

<b>MTTF<sub>D</sub></b>	968 years
<b>DC<sub>avg</sub></b>	0 %
<b>T<sub>M</sub> (mission time)</b>	20 years

## Classifications

<b>ECLASS 5.0</b>	27270901
<b>ECLASS 5.1.4</b>	27270901
<b>ECLASS 6.0</b>	27270901

<b>ECLASS 6.2</b>	27270901
<b>ECLASS 7.0</b>	27270901
<b>ECLASS 8.0</b>	27270901
<b>ECLASS 8.1</b>	27270901
<b>ECLASS 9.0</b>	27270901
<b>ECLASS 10.0</b>	27270901
<b>ECLASS 11.0</b>	27270901
<b>ECLASS 12.0</b>	27270901
<b>ETIM 5.0</b>	EC002716
<b>ETIM 6.0</b>	EC002716
<b>ETIM 7.0</b>	EC002716
<b>ETIM 8.0</b>	EC002716
<b>UNSPSC 16.0901</b>	39121528

### Adjustments

No adjustment possibility

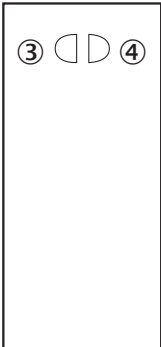

- ③ LED indicator yellow: Status of received light beam
- ④ LED indicator green: power on

### Connection type

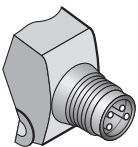

## Connection diagram

Cd-077

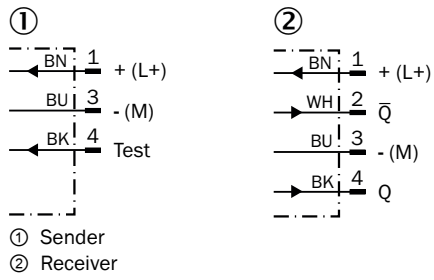

## Characteristic curve

WSE9-3, red light, 10 m

Operating reserve

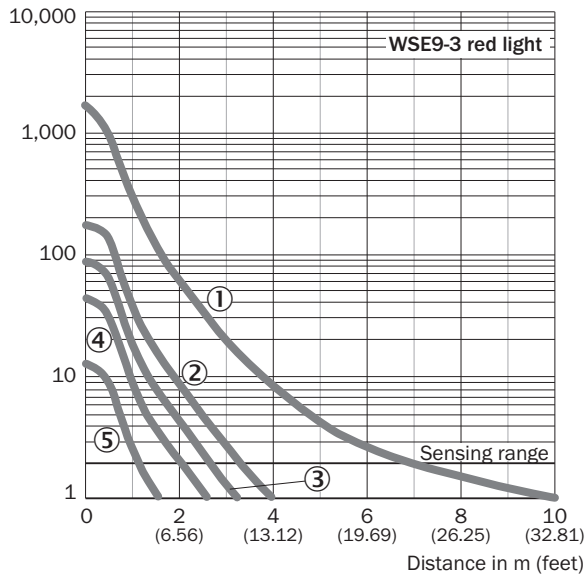

- ① Without masks
- ② With slotted mask, width 2.0 mm
- ③ With slotted mask, width 1.5 mm
- ④ With slotted mask, width 1.0 mm
- ⑤ With slotted mask, width 0.5 mm

### Light spot size

WSE9-3, red light, 10 m

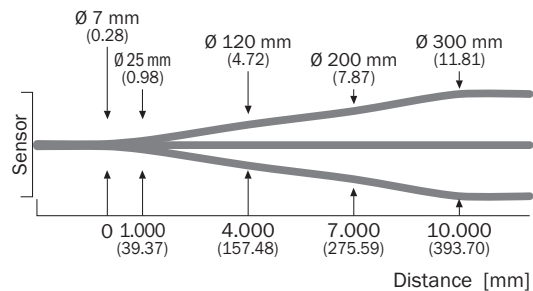

### Sensing range diagram

WSE9-3, red light, 10 m

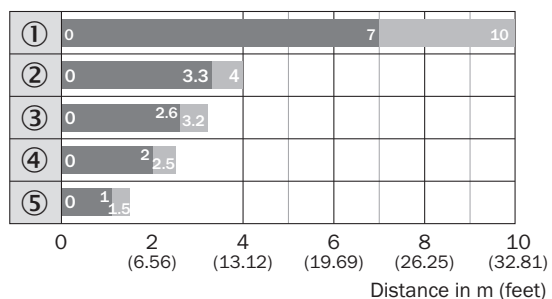

- Sensing range      ■ Sensing range, max. typ.
- ① Without masks
  - ② With slotted mask, width 2.0 mm
  - ③ With slotted mask, width 1.5 mm
  - ④ With slotted mask, width 1.0 mm
  - ⑤ With slotted mask, width 0.5 mm

**Dimensional drawing** (Dimensions in mm (inch))

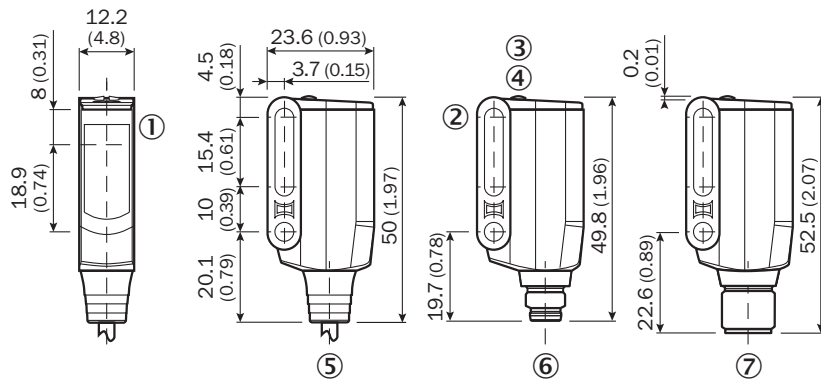

WL9M4-3, WSE9M4-3



- ① Sender and receiver optical axis center
- ② Mounting hole M4 (Ø 4.1 mm)
- ③ LED indicator yellow: Status of received light beam
- ④ LED indicator green: power on
- ⑤ Connecting cable or connector
- ⑥ Male connector M8, 4-pin
- ⑦ Male connector M12, 4-pin

**Recommended accessories**

Other models and accessories → [www.sick.com/W9](http://www.sick.com/W9)

	Brief description	Type	Part no.
<b>Mounting brackets and plates</b>			
	Mounting bracket for wall mounting, steel, zinc coated, mounting hardware included	BEF-W160	5305197
<b>Plug connectors and cables</b>			
	Head A: female connector, M8, 4-pin, straight, A-coded Head B: Flying leads Cable: Sensor/actuator cable, PVC, unshielded, 5 m	YF8U14-050VA3XLEAX	2095889
	Head A: male connector, M8, 4-pin, straight Cable: unshielded	STE-0804-G	6037323

## SICK AT A GLANCE

SICK is one of the leading manufacturers of intelligent sensors and sensor solutions for industrial applications. A unique range of products and services creates the perfect basis for controlling processes securely and efficiently, protecting individuals from accidents and preventing damage to the environment.

We have extensive experience in a wide range of industries and understand their processes and requirements. With intelligent sensors, we can deliver exactly what our customers need. In application centers in Europe, Asia and North America, system solutions are tested and optimized in accordance with customer specifications. All this makes us a reliable supplier and development partner.

Comprehensive services complete our offering: SICK LifeTime Services provide support throughout the machine life cycle and ensure safety and productivity.

For us, that is “Sensor Intelligence.”

## WORLDWIDE PRESENCE:

Contacts and other locations –[www.sick.com](http://www.sick.com)