

Control
number

02013-1E-501

VDI GROUP SA



| | |
|-----------------|------------|
| SPECIFICATION | |
| LITHIUM BATTERY | |
| Ordering Code : | CR-2477/BN |
| Model Code : | CR2477 |

| |
|---------------------|
| Approved by |
| Division/Department |
| Name |
| Title |
| Signature/date |

ISSUED
08,19,2013
PT. Panasonic Gobel Energy Indonesia

Date of Issued : Sep,3,2013

PT. Panasonic Gobel Energy Indonesia

| Approved | Checked | Drafted |
|---|---|--|
|  |  |  |

Revision history

| No. | Date | Revision |
|-----|------------|----------|
| 1 | Sep,3,2013 | Issued |
| 2 | | |
| 3 | | |
| 4 | | |
| 5 | | |
| 6 | | |
| 7 | | |
| 8 | | |
| 9 | | |
| 10 | | |
| 11 | | |
| 12 | | |
| 13 | | |
| 14 | | |
| 15 | | |
| 16 | | |
| 17 | | |
| 18 | | |

1. Applicable range

This specification applies to manganese dioxide lithium batteries which are delivered from PT. Panasonic Gobel Energy Indonesia

2. Nominal specification

- 2.1. Model code (bare cell) CR2477
- 2.2. Nominal voltage 3V
- 2.3. Nominal capacity 1000 mAh
- 2.4. Operation temperature From -30 to 60 °C
(Please consult Panasonic in case continuous high-temperature usage conditions)
- 2.5. Storage Condition (Recommendable) Temperature : 5°C to 35°C, Humidity : 45~85%RH
- 2.6. Mass Refer to drawing 1
- 2.7. Dimension Refer to drawing 1
- 2.8. Battery composition Lithium primary battery composed of cathode from manganese dioxide anode from lithium and electrolyte from organic solvent and lithium salt. Both cathode and anode outer shells are made of Stainless Steel with Ni plating on surface

3. Battery characteristics

Table 1. CR2477 characteristics

| | Items | Test method | Temperature | | initial | After 1 year in room temperature |
|---|----------------------|---------------------------------|-------------|---------------------------------|---------|----------------------------------|
| 1 | Open circuit voltage | Voltage between terminals (Min) | 20 +/- 2°C | | 3.1V | 3.1V |
| 2 | Internal resistance | 1kHz sine wave method (Max.) | 20 +/- 2°C | | 25 Ω | - |
| 3 | Discharge duration | Continuous discharge (Std.) | 20 +/- 2°C | Load : 5.1kΩ cut offV : 2.0V | 1727h | 1693h |
| | | Continuous discharge (Min.) | | | 1545h | 1514h |

4. Indication

4.1. Below items are indicated on battery or its package

- Model code CR2477
- Nominal voltage 3V
- Plus polarity +
- Manufacturer or its brand : Panasonic
- Production country and Classification Made in Indonesia

(Design of indication can be changed without notice)

4.2. Production date

- Stated on minus side of battery
- First digit: End digit of dominical year; Second digit; Month (October=O, November=Y, December=Z)
- Example : 3Z (December/2013)

4.3. UL

This battery is certificate by UL and listed on file number MH12210

4.4 Production Site

PT. Panasonic Gobel Energy Indonesia, Jl.Teuku Umar Km. 44, Cikarang Barat Bekasi, Jawa Barat Indonesia

4.5 RoHS comply

The battery herein complies with EU battery directive (2006/66/EC). Since the batteries shall comply with EU battery directive (2006/66/EC), RoHS directive does not cover batteries. However, this battery does not use the Six substances restricted by RoHS directive. Therefore, each content of Six restricted substances is less than the maximum amount regulated by RoHS.

Drawing 1. Dimensions

Ordering code : CR2477

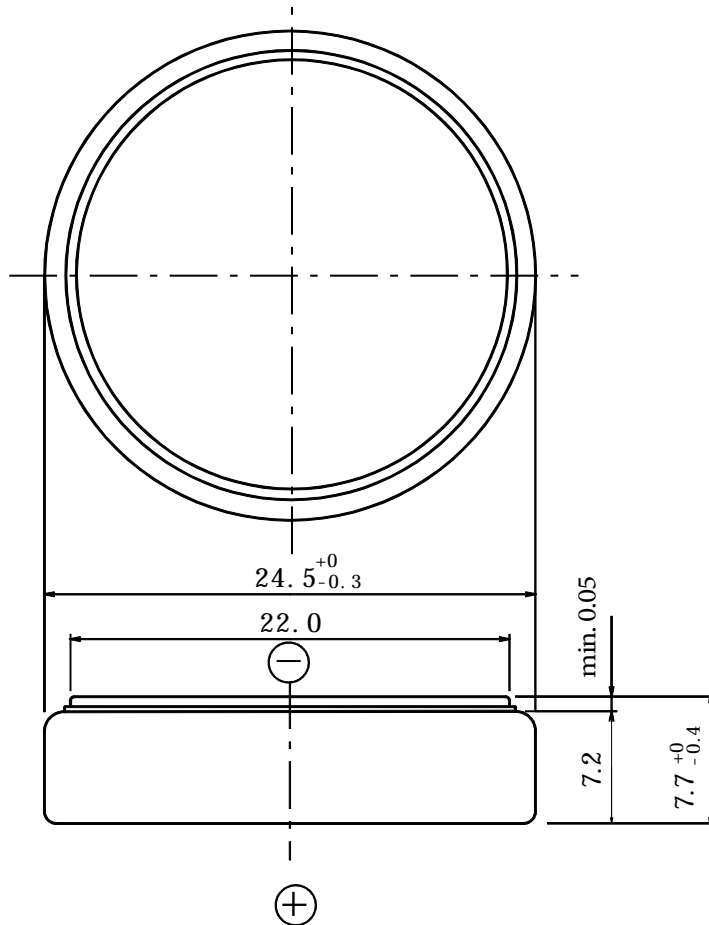

Terminal : Plus terminal material : Nickel plated stainless steel
Minus terminal material : Nickel plated stainless steel

Mass : Approx. 10.5 g

5. Test condition and performance

5.1. External dimensions

Measure the battery dimensions with caliper described in item 6.3.(1) herein without making short-circuit.
Dimensions shall be confirmed with drawing 1 herein.

5.2. Open circuit voltage

Measure the open circuit voltage with the voltage meter described in item 6.3.(2) herein after keeping the battery for 2 hours at least in measurement environment. Open circuit voltage shall conform to table 1 herein.

5.3 Internal resistance

Measure the internal resistance with the resistance meter described in item 6.3.(3) herein after keeping the battery for 2 hours at least in measurement environment. Internal resistance shall conform to table 1 herein.

5.4. Discharge duration

Discharge the battery with the load resistance specified in table 1 herein after keeping the battery in measurement environment for 8 hours at least. The discharge duration is determined as an operation time that the operation voltage reaches to the cut off voltage specified in the table 1 herein.

Discharge duration shall conform to table 1 herein.

5.5. Anti-leakage

Appearance check after 42 cycles of thermal cycle by the condition showing below. Battery shall not have deformation or leakage.

* This test shall be started from high temperature (60°C) position.

* No humidifying to ambient temperature and humidity.

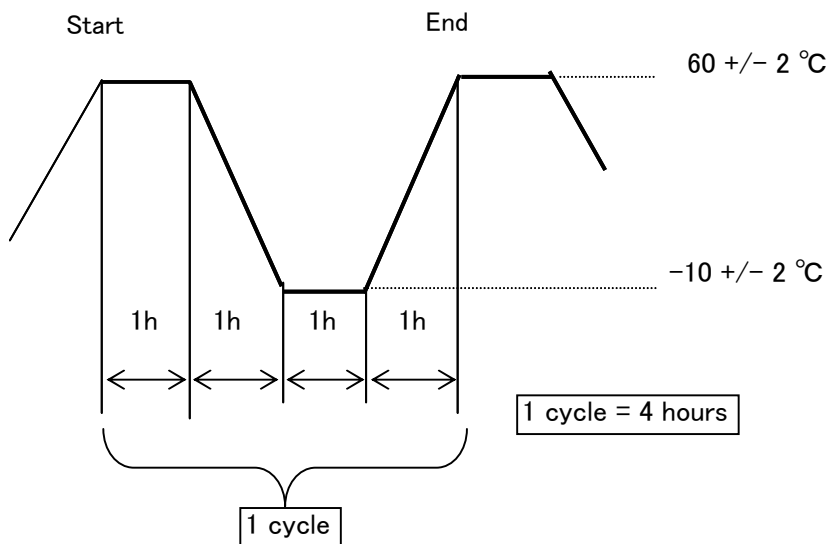

5.6. Storage characteristics

(1) Open circuit voltage

After storage term described on table 1 herein, keep the battery for 4 hours at least in measurement environment, then measure the open circuit voltage with the voltage meter described in item 6.3.(2) herein.

Open circuit voltage shall conform to table 1 herein.

(2) Internal resistance

After storage term described on table 1 herein, keep the battery for 4 hours at least in measurement environment, then measure the internal resistance with the resistance meter described in item 6.3.(3) herein. Internal resistance shall conform to table 1

(3) Discharge duration

After storage term described on table 1 herein, keep the battery for 8 hours at least in measurement environment, then discharge the battery with the load resistance specified in table 1 herein. The discharge duration is determined as an operation time that the operation voltage reaches to the cut off voltage specified in the table 1 herein.

Discharge duration shall conform to values described in table 1 herein.

5.7. Appearance

No deformation, bruise and stain which cause practical interference.

6. Test conditions

- 6.1. Initial test Initial test must be started within 2 months from delivery.
- 6.2. Temperature and humidity Unless otherwise specified, test should be carried out in room temperature (20 +/- 15 °C) and room humidity (65 +/- 20%RH).

6.3. Measuring equipment's

(1) Dimension

Micrometer defined by JIS B7502 or equivalent or more accurate one must be used for dimension measurement.

For one digit decimals tolerance, caliper with 0.05mm accuracy which is defined JIS B7507 or higher accuracy equipment must be used.

(2) Voltage

Voltage meter defined by JIS C1102 class 0.2 or higher, and more than 10Mohm impedance must be used.

(3) Internal resistance

It should be measured by sinusoidal current method (1kHz). Measurement should be finished within 5 seconds.

(As a general rule, Agilent Technologies LCRmeter 4263B or equivalent should be used.)

(4) Load resistance includes all resistance of discharge circuit, and its tolerance shall be less than 0.5%.

(5) Appearance check is observed by visual evaluation.

7. Revision and modification of this specification

Revision and modification must be carried out after the prior mutual agreement.

All accidents or issues caused by any events that are neither defined nor described in this specification, mutual discussion shall take place for the resolution.

8. Important Notes (Warranty)

- 1) The batteries are warranted to conform to the description contained in this specifications for a period of twelve **[12]** months from the ex-factory date and any claim by customer (apparatus manufacturer or distributor) must be made within such period. During that warranty period, if the batteries are proved to become defective, non-defective and conforming batteries will be supplied in due course at sole expense of Panasonic upon Panasonic's own determination that this is apparently caused by negligence of Panasonic.
- 2) Confirm and assure the matching and reliability of batteries on actual set or unit application with customer's responsibility.
- 3) Panasonic shall not warrant or be responsible in any case where customer fails to carry out proper handling, operating, installation, testing, service and checkout of the batteries and/or to follow the instruction, cautions, warnings, notes provided in this specifications, or other Panasonic's reasonable instructions or advise.
- 4) Panasonic will not be held responsible for any issues caused by modifications to the battery taken place after that the battery is delivered to the customer end.
The battery shall not be resoled to any other parties.
- 5) This product specification will be validated assuming that it is accepted when it is not returned within six months from the date of issue.

9. Precautions for use

9.1 Cautions for storage

- Store the battery at a constant temperature of 35 degree C or less in order to prevent deteriorations from heat.
- Keep the battery away from high humidity such as 85% RH or higher in order to prevent dew condensations on the battery that may cause to electrical leakage,
- Keep the battery away from heat sources i.e., boiler, radiator and etc., and from direct sunlight.

9.2 Warning for safety

Following cautions should be taken into consideration in order to use this battery in safe, since the battery contains combustible materials such as Lithium metal and organic electrolyte.

- Do not use except in applicable model or equipment.
- Do not mix fresh and used batteries.
- Do not mix different types (chemistries) of batteries.
- Do not short circuit.
- Do not charge.
- If multiple batteries are kept in contact with each other. The (+) and (-) terminals may short-circuit, and/or the charging possibly happen by other adjacent batteries, which may cause of shorten service life, significant damages and catching fire.
- Do not dispose into fire.
- Do not heat up higher than 100 .
- Do not solder direct to battery.
- Do not disassemble.
- Do not soak in water.
- Do not deform.
- Do not apply inadequacy modifications or remodeling on the batteries.
- Insert the batteries in the correct polarity position.

Warning for prevention of ingestion accident

- Small-sized batteries can easily be swallowed. They must be kept out of the reach of small children.
- Also, in the design of equipment using batteries, the care should be taken to ensure that batteries are NOT easy removable for children.

9.3 Caution for better usage

- Use gold-plated or nickel-plated steel or stainless steel strips for terminals in order to keep good conductivity with the battery surface. Terminals made of gold-plated phosphor bronze will ensure stable conductivity.
- Apply and keep the contact pressure more than 2N for stable conductivity.
- Before inserting batteries, check the terminal contact surfaces on both the equipment and the batteries are clean, and also check that they are not deformed. If the contact surfaces are dirty, clean up and dry them thoroughly before inserting batteries.
- Even if batteries of the same size or same shape, they may differ in type or grade. When replacing batteries, confirm that they are correct type by checking the identification symbol (designated by I.E.C. standards) which is marked on the battery and its packages.
- Lithium primary batteries continuously indicate high voltage even toward the end of their service life. As such, they may be mistakenly judged as yet being strong. In case of multiple batteries are used in an application or equipment, all batteries should be replaced at the same time when the one of those batteries shows it has totally consumed even other batteries seems still operating, since the remaining capacity in other batteries must be also quite little at the time.
- When multiple batteries are used in series in applications or equipments, it may occur that the one battery has a polarity inversion at the end of operation life. That behavior happen when the battery had consumed its capacity earlier than other batteries. Therefore, that is not failure of battery.
- When the Lithium battery has short-circuit, even slightly. A certain amount of time is required for recovering its voltage completely. If the electrical characteristics of the battery are

measured at a time before a sufficient time has passed, it may indicate unstable values due to the battery was in recovering mode.

- If the battery touch with any antistatic conductive materials include packing bags, trays, mats, sheets, films and resin cases, sheets, for example, have a resistance of 10^3 to 10^6 , it may cause of short-circuit since both the positive and the negative terminal of the battery may contact with those materials. In order to prevent short circuit, special attention may apply when handle batteries or battery attached PCB in close to those materials.

Notice for equipment design

- Keep batteries away from heat source or flame, and water.
- Please contact us in case of using multiple batteries.

Packaging specification

| | | | |
|---|--------------|--------------|---|
| Product No. : CR-2477/BN | Drawing No. | 232-C15-014N | * |
| Product name : Lithium battery coin type | Constitution | 2011.02.10 | |
| SPEC : 20pcs.tray × 100pcs.shrink packing × 100pcs.outer carton | | | |

1-Product

Refer to the product drawing

2-Tray for 20pcs.

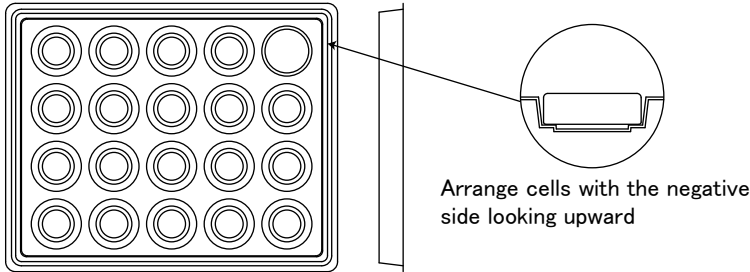

× 5

3-Shrink Packing for 100pcs.

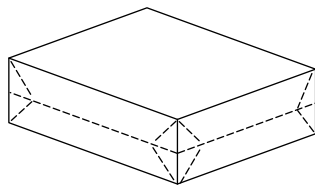

× 1

Empty tray as lid (2325-type) 1pc.



4-Outer Carton for 100pcs.

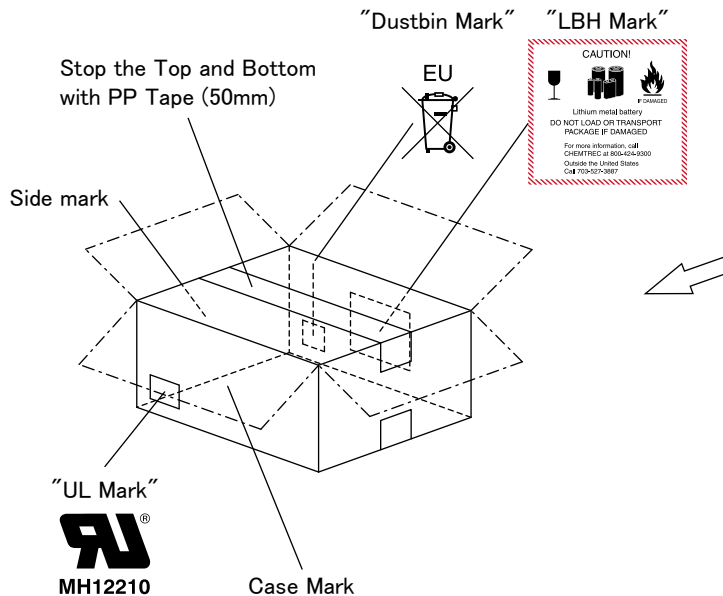

Arrangement

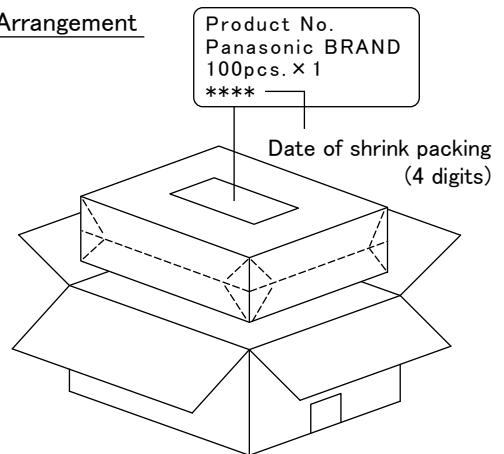

Fill the space with a buffer material

Packing List

| | |
|-----------|------------------------|
| Dimension | : 156 × 188 × 128mm |
| M3 | : 0.0038m ³ |
| Net | : 1.03kg 10.3g/1pc. |
| Gross | : 1.39kg |

unit: mm

S P E C I F I C A T I O N

. Precautions for Use

Please pay attention to the following points in order to maintain satisfactory operating conditions.

- * Use nickel plated(steel or stainless steel) for power terminal contacts.
- * To ensure stable contact, the contact pressure for power terminals must be at least 50 grams.
- * When measuring battery voltage, use a meter with an internal resistance of 1 MΩ or greater. Correct voltage measurements cannot be obtained otherwise.
- * Batteries are extremely sensitive to the adverse effects of humidity. Be sure to store them in a place which is dry and subject to little temperature change.
- * Do not place near the boiler or radiator, nor expose to the direct sunlight.
- * If button-type batteries are kept in contact with each other, the (+) and (-) terminals may short-circuit, greatly shortening their serviceable life.
- * Button-type batteries may expand slightly during use. Therefore, sufficient space must be provided for this expansion when designing equipment.
- * Before inserting batteries, check to confirm that the terminal contact surfaces on both the equipment and the batteries are clean and that they are not deformed. If the contact surfaces are dirty, clean and dry them thoroughly before inserting batteries.
- * Batteries of the same size and shape may differ in type and grade. When exchanging batteries, confirm that they are the correct type by checking the identification symbol (designated by I.E.C. standards) provided on the battery.
- * Alkaline primary batteries continue to register high voltage even toward the end of their serviceable life. As such, they may be mistakenly judged as yet being strong. If one of several batteries being used in a set is found to be exhausted, it can be assumed that there is very little life remaining in the others even though they may continue to register high voltage. It is therefore advisable to exchange all of the batteries at the same time.
- * The direction of polarity in a battery may reverse as it nears the end of its serviceable life. This occurs when it is the first among several batteries being used in a set to be exhausted. It is not due to an abnormality in the battery itself.
- * When a lithium battery is short-circuited, even slightly, a certain amount of time is required for its voltage output to recover completely. If the electrical characteristics of the battery are measured before a sufficient amount of time has passed, the battery may appear to be malfunctioning when actually it is merely in a state of recovery.

The batteries should be used correctly, otherwise the set may be damaged due to leakage trouble. Therefore, keep the following precautions in mind.

- * Do not charge, short-circuit, disassemble, heat or dispose the batteries in fire.
- * Insert the batteries in correct polarity position.
- * Do not directly solder to batteries.
- * Do not use spent batteries with new ones.

Small-sized batteries can easily be swallowed. They must be kept out of the reach of small children. Also, in the design of battery powered equipment, care should be taken to ensure that batteries cannot be easily removed by children.

| 3 | | |
|---------------------|------------------|-------------------|
| 2 | | |
| 1 | | |
| Sym. | Date of Revision | Remarks |
| Date of stipulation | Stipulated | Described |
| May . 4. 1984 | | <i>H. Hattori</i> |

Battery Safety Practices

Avoiding hazards in lithium battery handling



Warning

Mishandling batteries can cause battery leakage, heat generation, rupture, ignition etc., that can lead to possible fire or injury.

Both of coin type and cylinder type of lithium batteries contain flammable materials such as lithium, organic solvent and other chemical ingredients. Improper handling of lithium batteries may result in heat generation, fire or explosion, with a risk of personal injury or damage. To prevent these accidents in battery handling, be sure to observe the following precautions.

1. Do not Short circuit

Direct connection of plus(+) and minus(-) poles may result in leakage, heat generation, explosion and/or fire.
Do not store and/or carry batteries with metallic product such as necklace. (Refer fig.1)

Fig. 1 Short circuit

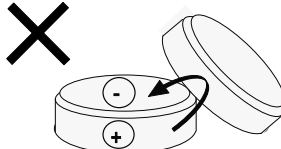

Fig. 2 stacked & jumble batteries



2. Do not stack and/or jumble batteries

Stacked and/or jumbled batteries may cause short circuit and/or forced discharge by the contact of other batteries. This may result in leakage, heat generation, explosion and/or fire.

Especially, a connection with the 006P(9V) type batteries may have a high risk of leakage, heat generation, explosion and/or fire. (Refer fig.2 & 3)

3. Do not make forced discharge batteries

Forced discharge by external power source, the battery voltage goes to negative and this cause gas generation in inside of the battery. This may result in leakage, heat generation, explosion and/or fire. (Refer fig.3)

* In your disposal and/or storage of the batteries, please isolate plus and minus poles by adhesive tape. A connection with other metals and/or batteries may result in leakage, heat generation, explosion and/or fire.

* When using the stored battery, please remove the tape perfectly to avoid high contact resistance problem. (Refer fig.4)

4. Do not dispose of batteries in fire

Disposal of batteries in fire is extremely dangerous with a risk of explosion and violent flaring.

5. Do not heat batteries

Heating batteries above 100 (212°F) may damage the resin in crimping, separator and other parts, causing electrolyte leak, internal short circuit, fire and explosion.

6. Do not solder directly onto batteries

Direct soldering onto batteries may damage the resin in crimping, separator and other parts, causing electrolyte leak, internal short circuit, fire and explosion.

7. Do not charge batteries

Charging of primary batteries may result internal gas generation, causing electrolyte leak, battery swelling, fire and explosion.

8. Do not disassemble batteries

Disassembly batteries may cause gas generation that may irritate your throat. Lithium may also react with moisture to generate heat and fire.

9. Do not deform batteries

Applying extreme pressure to batteries may cause deformation of the crimping and internal short circuit, causing electrolyte leak, battery swelling, fire and explosion.

10. Do not mix different type batteries

For some applications, mixing of different type batteries, or new and old batteries, can cause over discharge due to differences in voltage and discharge capacities. This may lead to the risk of swelling and/or explosion.

11. Do not insert batteries with opposite polarity

For some applications, battery insertion with opposite polarity (reverse insertion of plus and minus) may result in leakage, heat generation, explosion and/or fire.

Please ensure the above precautions are strictly observed by related divisions including production departments, sales departments and external subcontractors. For additional details and information, please contact our sales representatives.

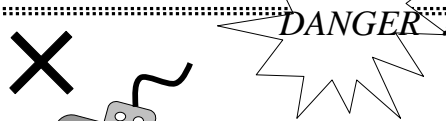
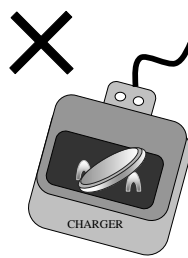

Fig. 3
Examples of forced discharge



Connection with battery charger

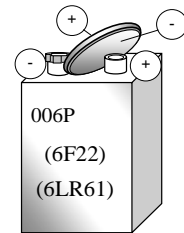
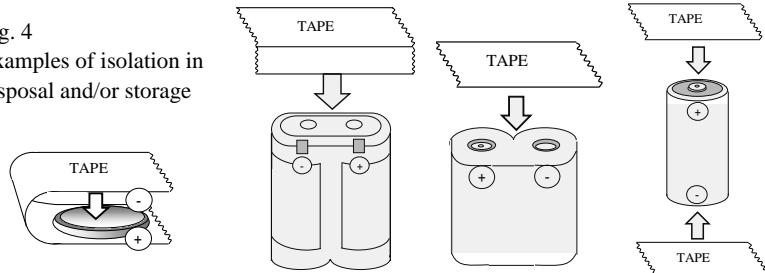

Fig. 4
Examples of isolation in disposal and/or storage



Beware of Antistatic Conductive Materials

Whenever terminal-mounted backup batteries or coin-type lithium batteries contact conductive materials, they discharge. Measures to protect semiconductor parts from static damage have been implemented in plants that use such ICs and LSIs. A number of protective materials are presently being used, and all contain blends of carbon, aluminum and other metals that make them conduct.

Antistatic conductive materials include packing bags, trays, mats, sheets, film and resin cases. Sheets, for example, have a resistance of 10^3 to $10^6 \Omega$, which means that when they contact the positive and negative terminals of a battery, they will discharge the battery.

In a lithium battery, a current flow of several μA to several mA reduces its voltage and electrical capacity. We recommend constant attention when using batteries around protective materials.

Examples

A terminal-mounted battery with its terminals inserted into a conductive mat is completely discharged after several days.

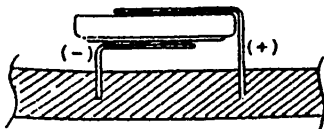

Conductive mat

A PCB-mounted battery is completely discharged by contact with the conductive resin case.

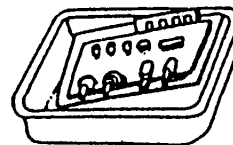

Conductive resin case

PCB-mounted batteries are discharged by contact with spacers and conductive rubber sheets.

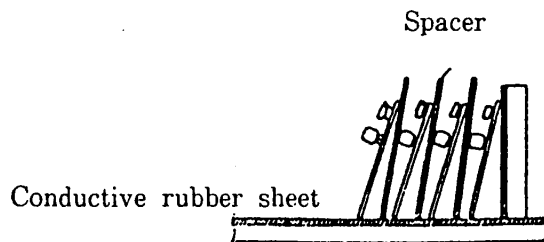

Conductive rubber sheet

Batteries left on a work bench with positive and negative terminals in direct contact with the grounded rubber sheet cover are completely discharged.

Ground wire
Conductive sheet

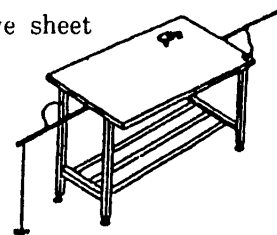

For more information, please make contact with your local dealer.

Preventing Accidental Memory Erasure

Coin-type Lithium batteries are widely used for memory backup purposes. However, there have been an increasing number of cases of accidental memory erasure due to inadequate battery contact.

To prevent unexpected memory erasure, consider the following tips for proper use.

< Long-term Continuous Battery Use >

- Use a battery with solderable tab terminals, so that the battery can be permanently soldered to terminal pads on the circuit board (Fig. 1).
- If the battery requires periodic replacement, use a battery holder (Fig. 2) or a battery with in-line lead connectors (Fig. 3).

The battery holder can be adjusted to suit any Panasonic lithium battery (Fig. 2).

< Batteries Requiring Short-Term Periodic Replacement --- Using batteries without solderable tab terminals or lead connectors >

- Use gold- or nickel-plated steel or stainless-steel strips for battery terminal contacts. Terminals made of gold-plated phosphor bronze will ensure contact with long-term stability.
- Y-shaped terminals (double contacts) for both the anode and cathode offer very stable contact (Fig. 4).

Each contact on the Y-shaped terminals requires a minimum contact pressure of 2-10N {approximately 200~1000gf} (Fig. 5).

- To guard against momentary contact failures of a few milliseconds in duration, use the tantalum capacitor-diode-resistor circuit shown in Fig. 6.
- * Do not touch the contact surfaces of the battery with bare hands, as this will increase the contact resistance and impair proper contact.

Figures 1 through 6 show examples of how to ensure proper battery contact.

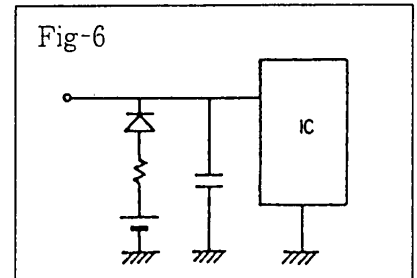
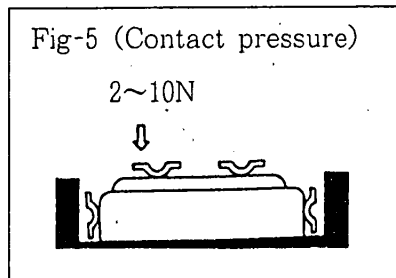
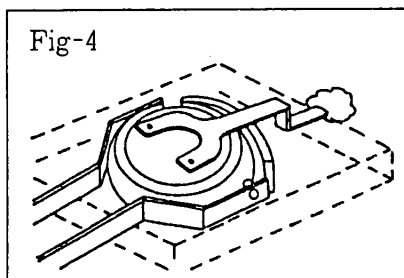
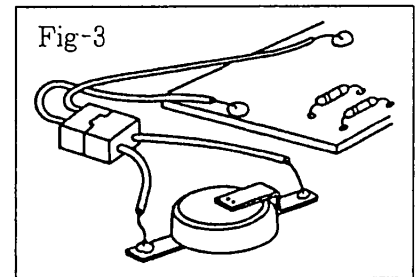
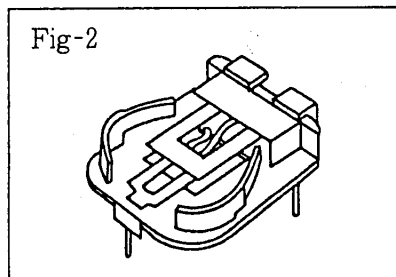
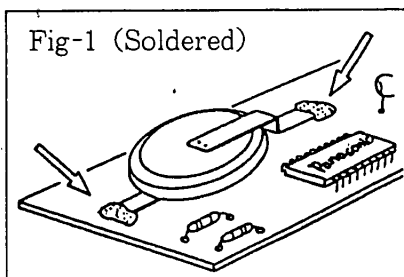

For more information, please make contact with your local dealer.