

User Manual Easy UPS On-Line SRVS1KIL, SRVS2KIL, SRVS3KIL SRVS1KRILRK, SRVS2KRILRK, SRV3KRILRK

Important Safety Instructions

Read the instructions carefully and look at the equipment to become familiar with the device before trying to install, operate, service or maintain it. The following special messages may appear throughout this document or on the equipment to warn of potential hazards or to call attention to information that clarifies or simplifies a procedure.



The addition of this symbol to a “Danger” or “Warning” safety label indicates that an electrical hazard exists which will result in personal injury if the instructions are not followed.



This is the safety alert symbol. It is used to alert you to potential personal injury hazards. Obey all safety messages that follow this symbol to avoid possible injury or death.

⚠ DANGER

DANGER indicates a hazardous situation which, if not avoided, **will result in death or serious injury.**

⚠ WARNING

WARNING indicates a hazardous situation which, if not avoided, **could result in death or serious injury.**

⚠ CAUTION

CAUTION indicates a hazardous situation which, if not avoided, **could result in minor or moderate injury.**

NOTICE

NOTICE is used to address practices not related to physical injury.

Product Handling Guidelines



For Professional Business Applications – Not for Consumer Use

Safety and General Information

Inspect the package contents upon receipt. Notify the carrier and dealer if there is any damages.

Read the Safety Guide before installing the UPS.

- This UPS is for indoor use only.
- Do not operate this UPS in direct sunlight, in contact with fluids, or where there is excessive dust or high humidity.
- Do not operate the UPS near open windows or doors.
- Be sure the air vents on the UPS are not blocked. Allow adequate space for proper ventilation.
Note: Allow a minimum of 20 cm clearance on all four sides of the UPS.
- Environmental factors impact battery life. Elevated ambient temperatures, poor quality utility power, and frequent discharges will shorten battery life. Follow the battery manufacturer recommendations.

Electrical Safety

- When grounding cannot be verified, disconnect the equipment from the utility power outlet before installing or connecting to other equipment. Reconnect the power cord only after all connections are made.
- Connection to the branch circuit (mains) must be performed by a qualified electrician.
- The protective earth conductor for the UPS carries the leakage current from the load devices (computer equipment). An insulated ground conductor is to be installed as part of the branch circuit that supplies the UPS. The conductor must have the same size and insulation material as the grounded and ungrounded branch circuit supply conductors. The conductor will be green and with or without a yellow stripe.
- The grounding conductor is to be grounded to earth at the service equipment, or if supplied by a separately derived system, at the supply transformer or motor generator set.

Battery Safety

⚠ CAUTION
<p>RISK OF HYDROGEN SULPHIDE GAS AND EXCESSIVE SMOKE</p> <ul style="list-style-type: none">• Replace the battery at least every 5 years.• Replace the battery immediately when the UPS indicates battery replacement is necessary.• Replace battery at the end of its service life.• Replace batteries with the same number and type of batteries as originally installed in the equipment.• Replace the battery immediately when the UPS indicates a battery over-temperature condition, or UPS internal over-temperature, or when there is evidence of electrolyte leakage. Power off the UPS, unplug it from the AC input, and disconnect the batteries. Do not operate the UPS until the batteries have been replaced.• *Replace all battery modules (including the modules in External Battery Packs) which are older than one year, when installing additional battery packs or replacing the battery module(s). <p>Failure to follow these instructions can result in injury.</p>

- * Contact Schneider Electric Worldwide Customer Support to determine the age of the installed battery modules.
- Servicing of user replaceable batteries should be performed or supervised by personnel knowledgeable about batteries and required precautions. In this case, batteries is not user replace.
- Schneider Electric uses Maintenance-Free sealed Lead Acid batteries. Under normal use and handling, there is no contact with the internal components of the batteries. Over charging, over heating or other misuse of batteries can result in a discharge of battery electrolyte. Released electrolyte is toxic and may be harmful to the skin and eyes.
- Use tool with insulated handles.
- Wear rubber gloves and boots.
- Determine if battery is either intentionally or inadvertently grounded. Contact with any part of a grounded battery can result in electric shock and burns by high short-circuit current. The risk of such hazards can be reduced if grounds are removed during installation and maintenance by a skilled person.
- Failed batteries can reach temperatures that exceed the burn thresholds for touchable surfaces.

Radio Frequency Warning

This is a category C2 UPS product as per IEC 62040-2. In a residential environment, this product may cause radio interference, in which case the user may be required to take additional measures.

Product Description

The Schneider Electric Easy UPS is a high performance, uninterruptible power supply (UPS). The UPS helps to provide protection for electronic equipment from utility power blackouts, brownouts, sags, and surges and small utility fluctuations and large disturbances. The UPS also provides battery backup power for connected equipment until utility power returns to normal levels or the batteries are fully discharged.







This user manual is available on the Schneider Electric website, www.se.com.

Package Contents

Read the Safety Guide before installing the UPS.

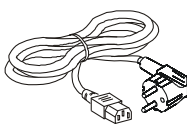
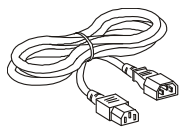
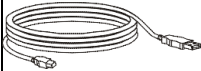
The packaging is recyclable; save it for reuse or dispose of it properly.

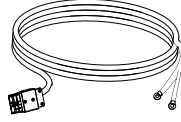
Common for all models

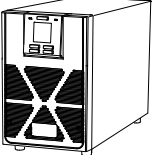
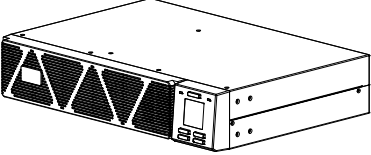
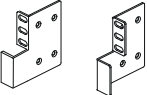
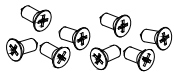
 (1) User manual	 (1) PowerChute™ Serial Shutdown	 (1*) Utility power cable	 (1**) Output cable
 (1) USB cable	 (1) RS-232 cable	 (1) Battery cable	 (2 sets) Screws & nuts
Tower Model		Rack-mounted Model	
 (1) UPS	 (1) UPS	 (2) Rack-mount bracket	 (8) Flat head screws

*: refer to below table.

** : only for the models with IEC outlet (10A).

NOTE: The model and serial numbers are located on a small label, top cover and rear panel.

For package contents of Battery pack, refer to the installation manual supplied along with Battery pack.

UPS Rating	1000 VA	2000 VA	3000 VA
Input Cable type	SCHUKO plug to IEC C13, 1.5 meters	SCHUKO plug to IEC C13, 1.5 meters	SCHUKO plug to IEC C19, 1.8 meters

Optional Accessories

For optional accessories, refer to the Schneider Electric Web site at www.se.com.

Specifications

Environment Specifications

NOTICE	
RISK OF EQUIPMENT DAMAGE	
<ul style="list-style-type: none"> • UPS must be used indoors only. • The installation location should be sturdy to withstand the weight of the UPS. • Do not operate UPS where there is excessive dust or where the temperature or humidity are outside specified limits. 	
Failure to follow these instructions can result in equipment damage.	

Temperature	Operating	0 to 40 °C at rated load 40 to 50 °C with derated load	<p>This unit is intended for indoor use only. Select a location sturdy enough to handle the weight. Do not operate UPS where there is excessive dust or where the temperature or humidity are outside specified limits.</p> <p>Note: Charge the battery modules every six months during storage.</p>
	Storage	-20 to 60 °C	
Elevation	Operating	0 - 2,000 m: normal operation > 2,000 m: The load reduces @ 1% at an increased height of every 100 m > 3,000 m: UPS will not work	
	Storage	0 - 15,000 m	
Humidity		0 to 95% relative humidity, non-condensing	
International Protection Code		IP20	
Type of Electrical Supply System		TT and TN	
Pollution Degree		2	
Overvoltage Category		II	
Applicable Standards		IEC 62040-1	

Physical Specifications

Tower Model

UPS model	SRVSPM1KIL	SRVSPM2KIL	SRVSPM3KIL
Dimensions with package Width x Height x Depth	235 x 330 x 365 mm (9.25 x 12.99 x 14.37 in)	235 x 355 x 525 mm (9.25 x 13.98 x 20.67 in)	325 x 465 x 565 mm (12.8 x 18.31 x 22.24 in)
Dimensions without package Width x Height x Depth	145 x 223 x 288 mm (5.7 x 8.78 x 11.34 in) *D1=256mm(10.8 in), *D2=348mm(13.7 in)	145 x 238 x 400 mm (5.7 x 9.37 x 15.75 in) *D1=363mm(14.3 in), *D2=460mm(18.1 in)	190 x 336 x 425 mm (7.5 x 13.2 x 16.7 in) *D1=393mm(15.5 in), *D2=495mm(19.5 in)
Weight with package	5.9 kg (13.00 lbs)	9.1 kg (20.06 lbs)	9.6 kg (21.16 lbs)
Weight without package	4.4 kg (9.70 lbs)	7.4 kg (16.31 lbs)	7.9 kg (17.42 lbs)

Rack-mounted Model

UPS model	SRVSPM1RKIL	SRVSPM2KRIL	SRVSPM3KRIL
Dimensions with package Width x Height x Depth	455 x 218 x 550 mm (17.9 x 8.6 x 21.7 in)	550 x 218 x 700 mm (21.7 x 8.6 x 27.56 in)	570 x 228 x 794 mm (22.4 x 9.0 x 31.3 in)
Dimensions without package Width x Height x Depth	438 x 86 x 312 mm (17.24 x 3.4 x 12.3 in) *D1=280mm(11.0 in), *D2=372mm(14.6 in)	438 x 86 x 462 mm (17.24 x 3.4 x 18.2 in) *D1=430mm(16.9 in), *D2=522mm(20.6 in)	438 x 86 x 632 mm (17.24 x 3.4 x 24.9 in) *D1=600mm(23.6 in), *D2=702mm(27.6 in)
Weight with package	9.3 kg (20.50 lbs)	13.4 kg (29.54 lbs)	13.7 kg (30.20 lbs)
Weight without package	6.0 kg (13.23 lbs)	9.2 kg (20.28 lbs)	9.5 kg (20.94 lbs)

*Details of D1 and D2

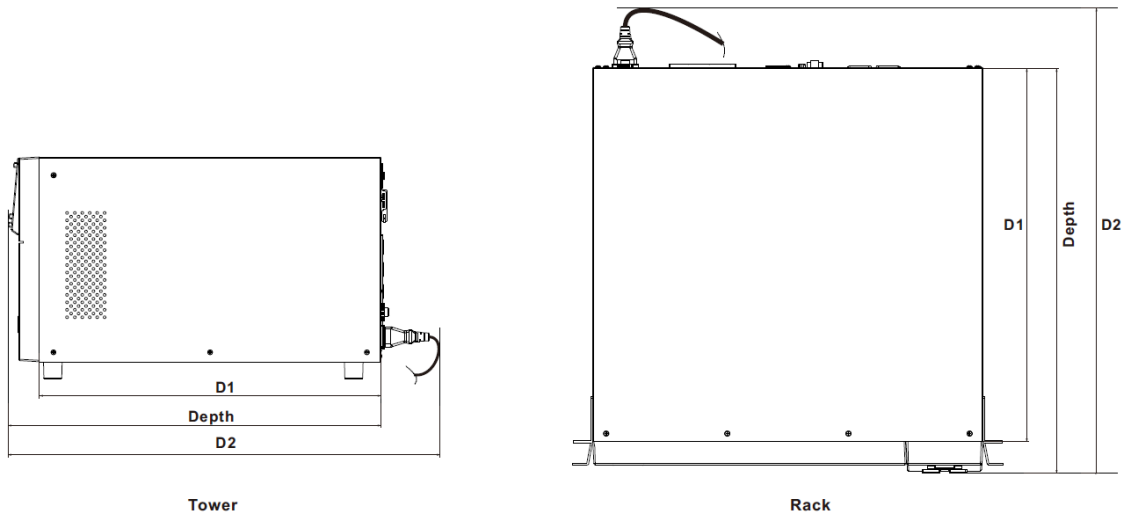

Input/Output Specifications

UPS Model		SRVSPM1KIL SRVSPM1KRIL	SRVSPM2KIL SRVSPM2KRIL	SRVSPM3KIL SRVSPM3KRIL
Input	Voltage	230 VAC Nominal		
	Frequency	40 – 70 Hz		
	Input Voltage Range (100% load)	160 VAC – 280 VAC		
	Input Voltage Range (40% load)	110 VAC – 285VAC		
	Input Power Factor (100% resistive load)	≥ 0.95		
	Input Protection	Input circuit breaker		
Output	UPS Capacity	1000 VA / 800 W	2000 VA / 1600 W	3000 VA / 2400 W
	Nominal Output Voltage	230 VAC		
	Other Programmable Voltage	220 VAC, 240 VAC		
	Efficiency at rated load	88% max.		
	Output Voltage Regulation	± 1% static		

	Output Voltage Distortion	<ul style="list-style-type: none"> • 3% max. for full linear load, • 6% max. for full non linear load (100% VA, 0.9 PF) • 15% for the last 60 seconds of the backup time (with full load only for the internal battery)
	Frequency – On Battery	50 Hz ± 0.5% or 60 Hz ± 0.5%
	Frequency – AC Mode	50 Hz ± 3 Hz or 60 Hz ± 3 Hz
	Crest Factor	3:1
	Waveform	Sinewave
	Short-Circuit Current	90A RMS, 800A Peak
	Output Connection	Please refer to rear panel features
	Bypass	Internal bypass, range 184 VAC to 253 VAC (+/-5%)

Battery

Tower Model

UPS Model	SRVS1KIL	SRVS2KIL	SRVS3KIL
Power Module	SRVSPM1KIL	SRVSPM2KIL	SRVSPM3KIL
Battery Pack Model	SRV36BP-9A	SRV72BP-9A	SRV72BP-9A
Configuration	External battery		
Type	Sealed, maintenance-free, Valve Regulated Lead-Acid battery 12 V, 9 Ah		
Typical Capacity	648 Wh	1296 Wh	1296 Wh
Nominal Voltage	36 V	72 V	72 V
Recommended Charge Voltage	40.8 V	81.6 V	81.6 V
Maximum Battery Pack Support	4		

* XLBP cable length - 600m (23.6 in).

Rack-mounted Model

UPS Model	SRVS1KRILRK	SRVS2KRILRK	SRVS3KRILRK
Power Module	SRVSPM1KRIL	SRVSPM2KRIL	SRVSPM3KRIL
Battery Pack Model	SRV36RLBP-9A	SRV72RLBP-9A	SRV72RLBP-9A
Configuration	External battery		
Type	Sealed, maintenance-free, Valve Regulated Lead-Acid battery 12 V, 9 Ah		
Typical Capacity	648 Wh	1296 Wh	1296 Wh
Nominal Voltage	36 V	72 V	72 V
Recommended Charge Voltage	40.8 V	81.6 V	81.6 V
Maximum Battery Pack Support	4		

* XLBP cable length - 600m (23.6 in).

Front Panel Display

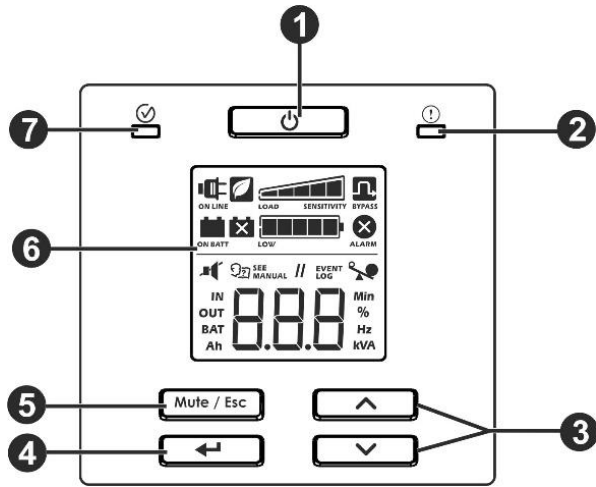





1	UPS POWER ON/OFF button
2	Alarm LED
3	UP/DOWN button
4	ENTER button
5	MUTE/ESC button
6	LCD Display
7	Status LED

Rear Panel Features



SRVSPM1KIL	SRVSPM2KIL	SRVSPM3KIL												
<table border="1" style="width: 100%; border-collapse: collapse;"> <thead> <tr> <th style="width: 50%;">Model</th> <th style="width: 50%;">Output type and quantity</th> </tr> </thead> <tbody> <tr> <td style="text-align: center;">SRVSPM1KIL</td> <td style="text-align: center;"> x 3 </td> </tr> </tbody> </table>	Model	Output type and quantity	SRVSPM1KIL	x 3	<table border="1" style="width: 100%; border-collapse: collapse;"> <thead> <tr> <th style="width: 50%;">Model</th> <th style="width: 50%;">Output type and quantity</th> </tr> </thead> <tbody> <tr> <td style="text-align: center;">SRVSPM2KIL</td> <td style="text-align: center;"> x 4 </td> </tr> </tbody> </table>	Model	Output type and quantity	SRVSPM2KIL	x 4	<table border="1" style="width: 100%; border-collapse: collapse;"> <thead> <tr> <th style="width: 50%;">Model</th> <th style="width: 50%;">Output type and quantity</th> </tr> </thead> <tbody> <tr> <td style="text-align: center;">SRVSPM3KIL</td> <td style="text-align: center;"> x6 x1 </td> </tr> </tbody> </table>	Model	Output type and quantity	SRVSPM3KIL	x6 x1
Model	Output type and quantity													
SRVSPM1KIL	x 3													
Model	Output type and quantity													
SRVSPM2KIL	x 4													
Model	Output type and quantity													
SRVSPM3KIL	x6 x1													

1	AC input	6	Battery connector
2	Input circuit breaker	7	Outlet Group (refer to outlet type and quantity on the bottom side)
3	USB port		
4	RS-232	8	Ground Screw
5	Intelligent card slot		

SRVSPM1KRIL		Model	Output type and quantity
		SRVSPM1KRIL	 x 4
SRVSPM2KRIL		Model	Output type and quantity
		SRVSPM2KRIL	 x 4
SRVSPM3KRIL		Model	Output type and quantity
		SRVSPM3KRIL	 x 6  x 1

1	AC input	6	Battery connector
2	Input circuit breaker	7	Outlet Group (refer to outlet type and quantity on the bottom side)
3	USB port		
4	RS-232	8	Ground Screw
5	Intelligent card slot		

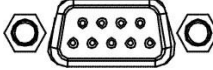
Basic Connectors

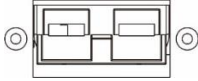
			<p>Power management software and interface kits can be used with the UPS. Use only interface kits supplied or approved by Schneider Electric.</p>
			<p>This UPS is not equipped internal battery. Before turn on the UPS. Please connect the battery by connecting battery cable to external battery.</p>

Rack-Mount Installation

⚠ CAUTION

RISK OF FALLING OBJECTS

- The equipment is heavy. Always practice safe lifting techniques adequate for the weight of the equipment.
- Always use the recommended number of screws to secure brackets to the UPS.
- Always use the recommended number of screws to secure the UPS to the rack
- Always install the UPS at the bottom of the rack.
- Always install the External Battery Pack below the UPS in the rack.

Failure to follow these instructions could result in equipment damage and minor or moderate injury.

- Before installing the UPS and battery pack into the 19-inch rack enclosure, be sure that the rack is already equipped with a shelf.
- Be sure that the installed shelf can withstand the weight of the UPS and/or battery pack. Otherwise, install an optional rail kit accessory **SRVSRK1** which can be purchased separately.

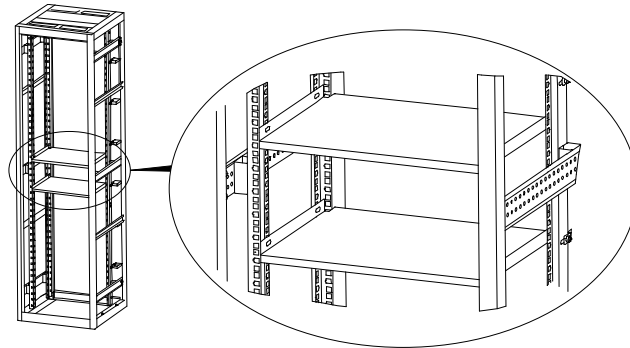

Refer to the below chart to install UPS and battery pack into 19" rack enclosure.

Lift the UPS module and slide it into rack enclosure. Secure the UPS module to the rack with screws, nuts and washers (not supplied in the package) through its mounting brackets into the rails.

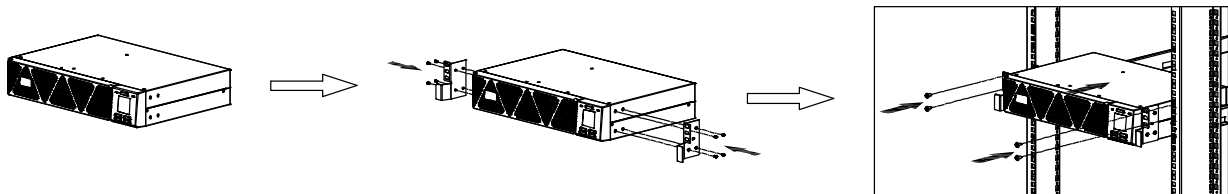

Start Up Settings

Attach the front bezel

Rack UPS is shipped without front bezel. Attach the front bezel first before use (shown at right).

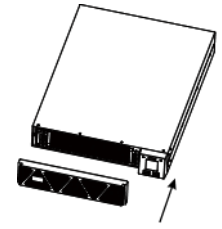

Connect the battery

For Tower UPS model, connect UPS to the external battery pack with a battery cable. Refer to right chart for external battery connection.

Please connect the battery according to the battery voltage indicated on the rear panel. If the connected battery voltage is incorrect, UPS may be damaged and cannot be repaired.

Therefore, be sure to confirm that the battery voltage is in accordance with the UPS specification.

For Rack UPS model, connect UPS to the external battery pack with supplied battery cable as shown below chart.

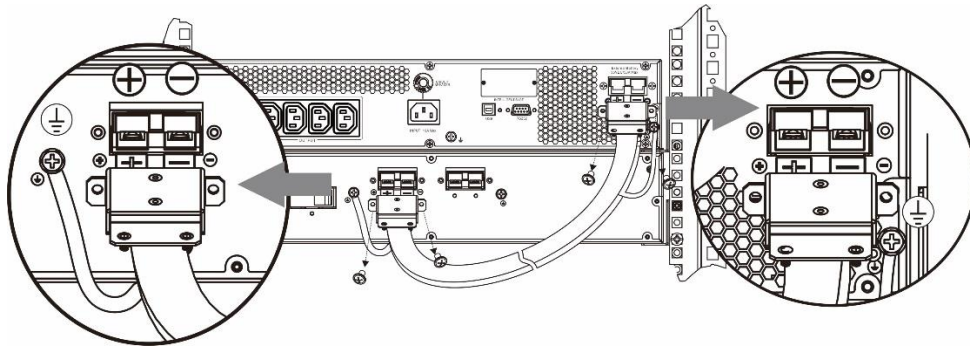
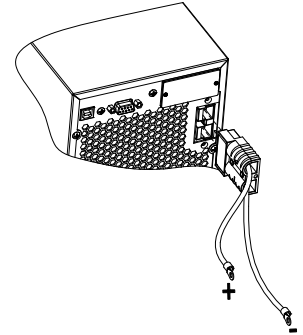

Refer to the User guide supplied with external battery pack while installing more than one external battery pack.

Connect power and equipment to the UPS

⚠ CAUTION

RISK OF ELECTRIC SHOCK

- All electrical work must be performed by a qualified electrician.
- Turn off all power to this equipment before working on the equipment. Practice lockout/tagout procedures.
- Do not wear jewelry when working with electrical equipment.

Failure to follow these instructions can result in minor or moderate injury and equipment damage.

1. Connect equipment to the UPS. Avoid using extension cords.
2. Connect input utility power to the UPS.
3. Switch on the input utility power. Then, the UPS display panel will illuminate when utility power is available.

Start the UPS

Press the POWER ON/OFF button located on the front panel of the UPS.

- The battery charges to 90% capacity during the first five hours of normal operation.
- **Do not** expect full battery run capability during this initial charge period.

Cold start the UPS

Use cold start feature to supply power to connected equipment from the UPS batteries.

Press the POWER ON/OFF button. Then, the display panel will illuminate. Press the POWER ON/OFF button again to supply battery power to the connected equipment.

Connect and install PowerChute™ UPS Management software

Easy UPS On-Line is provided with PowerChute™ UPS Management Software for unattended operating system shutdown, UPS monitoring, UPS control and energy reporting. The following diagram is a representation of a typical server installation.

1. Connect the USB cable from the rear of the UPS to the protected device such as a server.
Note: A USB driver is required to communicate with PowerChute over USB. For more information, refer to Knowledge Base article FAQ000223363 on the Schneider Electric website (<https://www.se.com/ww/en/faqs/home/>).

2. For a server or other device with an operating system, download and install latest version of the PowerChute Serial Shutdown from <https://www.se.com/ww/en/product-range/137943580-powerchute-serial-shutdown/#overview>. PowerChute Serial Shutdown supports graceful shutdown in the event of an extended power outage.
Note: PowerChute is a 64-bit only application and cannot be installed on a 32-bit operating system.

3. A built-in serial port is also available for additional communication options with serial cable.
Note: RS232 and USB cannot be used at the same time

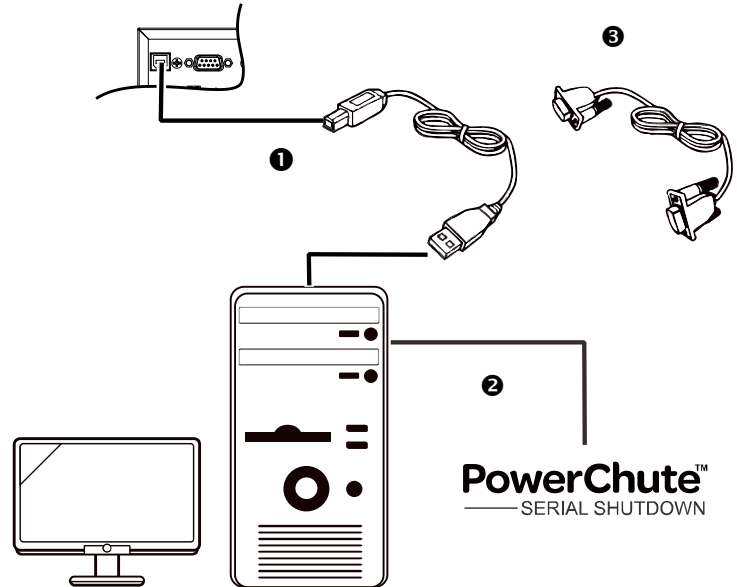

Operation

Using The Display





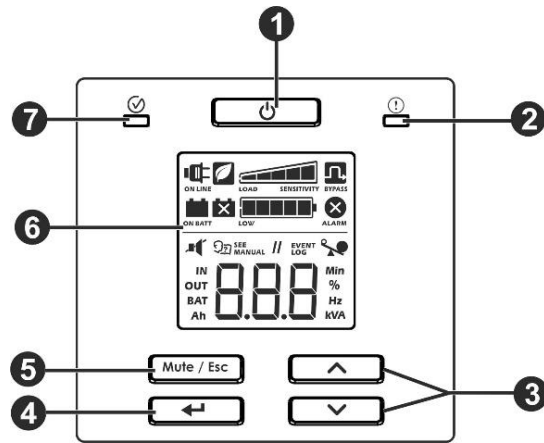



These Easy UPS models are equipped with an intuitive and configurable LCD display. This display complements the software interface as they convey similar information and either may be used to configure the UPS settings.



The display consists of the following keys and indicators:



①	POWER ON/OFF button	<ul style="list-style-type: none"> ● Press this button to turn on the UPS. ● Press and hold this button until a beep is heard to turn off the UPS. ● Press this button to reset alarms.
②	Alarm LED	This Alarm LED illuminates red when the UPS detects an internal error and blinks red for UPS notifications. See “Alerts and Notifications” on page 12 in this manual.
③	UP / DOWN button	Press these buttons to scroll up or down through the main menu options and display screens.
④	ENTER button	Press this button to enter the menu or to select a menu item/value during navigation.
⑤	MUTE/ESC button	<ul style="list-style-type: none"> ● To acknowledge audible alarms and suppress them temporarily. ● To exit a sub menu and return to the main menu.
⑥	LCD Display	The display interface options are visible on this LCD screen. Press the UP or DOWN button to activate LCD, if the display is not illuminated.
⑦	Status LED	<p>The Status LED illuminates green when the power is on. This LED indicates two different states of output power:</p> <ul style="list-style-type: none"> ● Output off: LED blinks. Press Power On/Off button to turn the output power on. ● Output on: LED illuminates green continuously.

LCD Display Icons

 ON LINE	On Line: The UPS is drawing utility power and performing double conversion to supply power to the connected equipment.
 ON BATT	On Battery: The UPS is supplying battery backup power to the connected equipment.
 REPLACE BATT	Replace Battery: The battery is not connected securely or the battery is nearing the end of its service life and should be replaced.
 BYPASS	Bypass: The UPS is in bypass mode, sending utility power directly to connected equipment. Bypass mode operation is the result of an internal UPS event or an overload condition. Battery operation is not available while the UPS is in bypass mode. See “Alerts and Notifications” on page 13 in this manual.
 ALARM	System Alarms: An internal error is detected. See “Alerts and Notifications” on page 12 in this manual.
 OVERLOAD	Overload: The equipment connected to the UPS is drawing more power than the UPS rating.
 LOW	Battery Charge: The battery charge level is indicated by the number of illuminated bar sections. When all five blocks are illuminated, the battery is fully charged. Each bar represents approximately 20% of the battery charge capacity.
 LOAD SENSITIVITY	Load Level: The load percentage is indicated by the number of illuminated load bar sections. Each bar represents approximately 20% of the maximum load capacity.

	Mute: An illuminated line through the icon indicates that the audible alarm is disabled.
	Green Mode: An illuminated icon indicates that the unit is working in Green mode. The connected equipment is receiving the utility input directly as long as the input voltage and frequency are within the configured limits.
 SEE MANUAL	Alarm or notification: The UPS has detected an internal error or the UPS is in configuration mode. See “Alerts and Notifications” on page 12 in this manual.
EVENT LOG	Event: The icon is illuminated when the user is viewing the event log.

Alerts and Notifications

Status Indicators

Continuous beeps, every half second	Low Battery State - The battery is nearing its complete discharge state. The UPS is about to shut down. Overload condition - The equipment connected to the UPS is drawing more power than rated.
4 beeps every 30 sec (first beep starts after 4 sec on battery)	On Battery State - The UPS is supplying battery backup power to the connected equipment.
Beeper continuously on	Alarm State - UPS has detected an internal error. See “Alerts and Notifications” in this manual.
Short beep every 2.5 sec	Battery disconnected.
Continuous short beeps for every half second for 1 minute, repeats every 5 hours.	Bad battery (replace the battery)
Two short beeps every 5 sec	Event Bypass State - UPS has detected an internal error. Connected equipment receives utility input power through the bypass relay.

Alerts

Display code	Description	Solution
SC	UPS has experienced a short circuit at the output terminals. Unit will try to auto-recover from this condition.	Check if there is any short circuit at the UPS output terminals. Remove the short circuit, wait for the unit to auto-recover or Press POWER ON/OFF button to start the UPS.
OL	UPS is experiencing an overload condition.	Disconnect nonessential equipment from the UPS to eliminate the overload condition.
dCH	The UPS has detected a DC voltage error. Unit will try to auto-recover from this condition.	If the UPS does not recover automatically, contact Schneider Electric Customer Support.
Hot	Temperature of the unit is rising above the set limits.	Disconnect nonessential equipment from the UPS to reduce the UPS load. Ensure that ambient temperature is within limits. Ensure that adequate clearance is maintained.
CH9	UPS has detected a charger error.	Press POWER ON/OFF button to start the UPS. If the charger error is persists, contact Schneider Electric Customer Support.

Contact Schneider Electric Customer Support for all other alert codes.

Notifications

Display code	Description	Solution
	Battery is not connected.	Connect battery to the UPS. Refer “Connect the battery” on page 9 for details.

UPS Display Parameters

Operational data displayed in the display panel is given in the table.

Navigate using the UP or DOWN button.

Parameter	Units	Indicator Icons
Output voltage	Vac	OUT, V
Output frequency	Hz	OUT, Hz
Input voltage	Vac	IN, V
Input frequency	Hz	IN, Hz
Battery voltage	V DC	BAT, V
Ambient temperature	° C	NUMBER, C
State of battery charge	%	BAT, %
Load level in percentage (Maximum of	%	OUT, %
Load level in kVA	kVA	OUT, kVA
Total Ah capacity of connected battery	Ah	BAT, Ah
Remaining On Battery runtime	Minutes	BAT, Min

Configuration

Configure UPS Parameters

Follow the steps to configure parameters in the UPS:

1. Press the ENTER button.
2. Press the UP/DOWN button to navigate to “Set”.
3. Press the ENTER button.
4. Navigate through the parameters using the UP/DOWN button.
5. Press the ENTER button to edit a parameter. Icons start flashing to indicate the editing.
6. Press the UP/DOWN button to navigate between the options available for the selected parameter.
7. Press the ENTER button to select the option or MUTE/ESC button to abort the editing of current parameter. Flashing of icons stops after this.
8. Press the UP/DOWN button to navigate between parameters.
9. Press the MUTE/ESC button to exit menu navigation.

UPS Settings

Configure UPS settings using the display interface. See “Configure UPS parameters” section to edit the parameters.

Function	Factory Default	User Selectable Options	Description
Output voltage	230 VAC	220, 230, 240 VAC	Allows the user to select output voltage while the UPS is operating online.
Audible alarm	Enable	Enable, disable	UPS will mute audible alarms when set to disable or when the MUTE button is pressed.
Green mode/ high efficiency mode	Disabled	Enable/Disable	When this mode is enabled, connected equipment receives utility input power through the bypass relay as long as input voltage is within the range of $\pm 5\%$ of configured output voltage and ± 3 Hz of configured output frequency. Inverter is turned off during this mode. If utility power input goes out of range, inverter is turned on. The load is transferred to online mode or battery mode. The power to the connected equipment may be interrupted up to 10 milliseconds.
Minimum battery capacity to restart setting	0%	0%, 15%,50%,90%,	UPS output will not be turned on until the battery is charged to a level such that it can provide the runtime configured by this setting. If configured to 0%, UPS output is turned on immediately after utility power returns.
Low battery state indication setting	2 min	2 min, 5 min, 7min, 10min,	The UPS will emit audible alarm when the actual run time reaches the limit set by the user. The audible alarm will emit only when the UPS is working in battery mode.

Advance Display Navigation

There are five options in main menu and two sub-menu options in UPS display. Press the ENTER button from the Home Screen to access these menu options. Use the UP/DOWN button to navigate between the menu options.

Menu Option	Description								
SET	<p>Configure the UPS Use this menu option to configure the UPS parameters. Press the ENTER button to see the configuration options. Refer “Configure UPS parameters” on page 13 for details. Press the MUTE/ESC button to return to the Home Screen.</p>								
LOG	<p>Show Event Log Use this menu option to see the UPS event log. The UPS records the last 10 events and displays the codes in this log. Press the ENTER button to see the log. Use the UP/DOWN button to see the logged events. The DOWN button navigates towards old events and the UP button navigates to new events. Every log entry has a numeric and textual event code. At the end of the log, the word “End” will be displayed. Press the MUTE/ESC button to return to the Home Screen.</p>								
UPS	<p>Show UPS information Use this menu option to see the UPS information. Press the ENTER button to see the rating of the UPS. Press the UP button to see the UPS firmware version. Press the MUTE/ESC button to return to the Home Screen.</p>								
byp	<p>User Command to bypass Use this menu option to switch the UPS to bypass mode or to online mode. Press ENTER button:</p> <table border="0"> <tr> <td>Put</td> <td>Put: Use to switch the UPS to bypass mode of operation.</td> </tr> <tr> <td>Out</td> <td>Note: Power to the connected equipment will drop, if the mains voltage is not within the threshold limits.</td> </tr> <tr> <td></td> <td>Out: Bring the UPS out of bypass and restore clean power to the connected equipment. The Easy UPS will start a count down on the display while switching to Bypass mode or coming out of Bypass mode.</td> </tr> </table>	Put	Put: Use to switch the UPS to bypass mode of operation.	Out	Note: Power to the connected equipment will drop, if the mains voltage is not within the threshold limits.		Out: Bring the UPS out of bypass and restore clean power to the connected equipment. The Easy UPS will start a count down on the display while switching to Bypass mode or coming out of Bypass mode.		
Put	Put: Use to switch the UPS to bypass mode of operation.								
Out	Note: Power to the connected equipment will drop, if the mains voltage is not within the threshold limits.								
	Out: Bring the UPS out of bypass and restore clean power to the connected equipment. The Easy UPS will start a count down on the display while switching to Bypass mode or coming out of Bypass mode.								
tst	<p>Execute Battery Self-Test Use this menu option to conduct a self-test and determine the battery status. Press the ENTER button to initiate the test. If the test command is accepted, the UPS will initiate a self-test and will start a count down on the display. Display messages are shown at the end of the test.</p> <table border="0"> <tr> <td>rFd</td> <td>Test refused. The output is off or battery is not charged.</td> </tr> <tr> <td>FId</td> <td>Test not passed</td> </tr> <tr> <td>PAS</td> <td>Test passed</td> </tr> <tr> <td>Abt</td> <td>Test is aborted due to internal reasons</td> </tr> </table> <p>Press the MUTE/ESC button to return to the Home Screen</p>	rFd	Test refused. The output is off or battery is not charged.	FId	Test not passed	PAS	Test passed	Abt	Test is aborted due to internal reasons
rFd	Test refused. The output is off or battery is not charged.								
FId	Test not passed								
PAS	Test passed								
Abt	Test is aborted due to internal reasons								

Troubleshooting

Use the table below to solve minor installation and operation problems. Refer to the Schneider Electric Web site, www.se.com for assistance with complex UPS problems.

Problem and/or Possible Cause	Solution
UPS will not turn on when utility input is available or there is no power output	
The UPS is not turned on.	Press the POWER ON/OFF button to turn on the UPS.
The UPS is not connected to utility power supply.	Check that the power cable from the UPS to the utility power supply is securely connected at both ends. See “Start Up” on page 9 in this manual.
Input thermal circuit breaker on the UPS is tripped.	Press the input thermal circuit breaker reset button in the rear panel.
The UPS is operating on battery, while connected to the input utility power	
There is high, low, or distorted input voltage or frequency.	Connect the UPS to a different outlet on a different circuit. Test the utility input power to ensure the unit is receiving input power. If display is on, navigate and check the input voltage and frequency.
UPS, when connected to battery, is not supplying power to the connected equipment	
The UPS is not turned on.	If the UPS has shutdown (the display is not on), follow the procedure “Cold start the UPS” on page 9.
The battery is not connected.	Connect battery to the UPS. See “Start Up” on page 9 in this manual.
Low battery cut off. UPS may have discharged the battery due to utility power outage and turned the output off due to low battery condition.	Wait for the utility power to return and charge the battery. To turn on the output power after utility power returns, press POWER ON/OFF button.
UPS emits an audible beeping sound at long intervals	
The UPS is operating normally when running on battery.	UPS has detected an error. See “Alarms and Notifications” on page 12 in this manual.
Alarm LED is illuminated. The UPS displays an alarm message and emits a constant beeping sound	
The UPS has detected an error.	See “Alarms and Notifications” on page 12 in this manual.
No audible sounds from UPS even when the Alert LED is illuminated.	
Audible alarm is disabled.	Change the UPS configuration to enable audible alarms.
UPS is not providing expected backup time.	
The UPS battery is discharged due to a recent power outage.	The batteries require recharging after extended outages. Batteries can wear faster when put into service without proper recharging or when operated at elevated temperatures.
The battery is near the end of its service life.	If the battery is near the end of its service life, consider replacing the battery, even if the replace battery indicator is not illuminated. See “Start Up” on page 9 in this manual.

Problem and/or Possible Cause	Solution
UPS is not turning off	
POWER OFF button not pressed properly	Press and hold the POWER ON/OFF button until the beep is heard to power off the UPS.
Utility input power is available.	UPS logic power can not be turned off if utility input power is available. To turn off the UPS, turn off utility input power and press POWER ON/OFF button. Release when a beep is heard.
UPS is in Bypass mode and the LED is not illuminated red.	
UPS is in green mode.	Disable green mode if not desired.
UPS is configured to stay in the bypass mode.	Change the configuration to exit bypass mode.
UPS is in bypass mode even after over temperature alarm is cleared.	Reduce the connected load to <90% to bring the UPS to online mode.
The UPS has experienced an overload condition and transferred to bypass.	<p>Connected equipment exceeds the “maximum load” as defined in specifications on the Schneider Electric Website, www.se.com.</p> <p>The alarms remain on until the overload condition is corrected. Disconnect nonessential equipment from the UPS to eliminate the overload condition.</p> <p>The UPS continues to supply power as long as it is in bypass mode and the circuit breaker does not trip. The UPS will not provide battery power in the event of a utility voltage interruption.</p>
UPS detected an error and transferred to bypass.	See “Alarms and Notifications” on page 12 in this manual.

Transport

1. Shut down and disconnect all connected equipment.
2. Disconnect the unit from mains power.
3. Disconnect all internal and external batteries (if applicable).
4. Follow the shipping instructions outlined in the *Service* section of this manual.

Service

If the unit requires service, do not return it to the dealer. Follow these steps:

1. Review the *Troubleshooting* section of the manual to eliminate common problems.
2. If the problem persists, contact Schneider Electric Customer Support through the Schneider Electric Web site, **www.se.com**.
 - a. Note the model number and serial number and the date of purchase. The model and serial numbers are located on the top cover of the unit and are available through the LCD display on select models.
 - b. Call Customer Support. A technician will attempt to solve the problem over the phone. If this is not possible, the technician will issue a Returned Material Authorization Number (RMA#).
 - c. If the unit is under warranty, the repairs are free.
 - d. Service procedures and returns may vary internationally. For country specific instructions refer to the Schneider Electric Web site, **www.se.com**.
3. Pack the unit properly to avoid damage in transit. Never use foam beads for packaging. Damage sustained in transit is not covered under warranty.
Note: Before shipping, always disconnect battery modules in a UPS or external battery pack. The disconnected internal batteries may remain inside the UPS or external battery pack.
4. Write the RMA# provided by Customer Support on the outside of the package.
5. Return the unit by insured, prepaid carrier to the address provided by Customer Support.

Limited Factory Warranty

Schneider Electric IT Corporation (SEIT), warrants its products to be free from defects in materials and workmanship for a period of two (2) years from the date of purchase. The SEIT obligation under this warranty is limited to repairing or replacing, at its own sole option, any such defective products. Repair or replacement of a defective product or part thereof does not extend the original warranty period.

This warranty applies only to the original purchaser who must have properly registered the product within 10 days of purchase. Products may be registered online at warranty.se.com.

SEIT shall not be liable under the warranty if its testing and examination disclose that the alleged defect in the product does not exist or was caused by end user or any third person misuse, negligence, improper installation, testing, operation or use of the product contrary to SEIT recommendations of specifications. Further, SEIT shall not be liable for defects resulting from: 1) unauthorized attempts to repair or modify the product, 2) incorrect or inadequate electrical voltage or connection, 3) inappropriate on site operation conditions, 4) Acts of God, 5) exposure to the elements, or 6) theft. In no event shall SEIT have any liability under this warranty for any product where the serial number has been altered, defaced, or removed.

EXCEPT AS SET FORTH ABOVE, THERE ARE NO WARRANTIES, EXPRESS OR IMPLIED, BY OPERATION OF LAW OR OTHERWISE, APPLICABLE TO PRODUCTS SOLD, SERVICED OR FURNISHED UNDER THIS AGREEMENT OR IN CONNECTION HEREWITH. SEIT DISCLAIMS ALL IMPLIED WARRANTIES OF MERCHANTABILITY, SATISFACTION AND FITNESS FOR A PARTICULAR PURPOSE.

SEIT EXPRESS WARRANTIES WILL NOT BE ENLARGED, DIMINISHED, OR AFFECTED BY AND NO OBLIGATION OR LIABILITY WILL ARISE OUT OF, SEIT RENDERING OF TECHNICAL OR OTHER ADVICE OR SERVICE IN CONNECTION WITH THE PRODUCTS.

THE FOREGOING WARRANTIES AND REMEDIES ARE EXCLUSIVE AND IN LIEU OF ALL OTHER WARRANTIES AND REMEDIES. THE WARRANTIES SET FORTH ABOVE CONSTITUTE SEIT'S SOLE LIABILITY AND PURCHASER EXCLUSIVE REMEDY FOR ANY BREACH OF SUCH WARRANTIES. SEIT WARRANTIES EXTEND ONLY TO ORIGINAL PURCHASER AND ARE NOT EXTENDED TO ANY THIRD PARTIES.

IN NO EVENT SHALL SEIT, ITS OFFICERS, DIRECTORS, AFFILIATES OR EMPLOYEES BE LIABLE FOR ANY FORM OF INDIRECT, SPECIAL, CONSEQUENTIAL OR PUNITIVE DAMAGES, ARISING OUT OF THE USE, SERVICE OR INSTALLATION OF THE PRODUCTS, WHETHER SUCH DAMAGES ARISE IN CONTRACT OR TORT, IRRESPECTIVE OF FAULT, NEGLIGENCE OR STRICT LIABILITY OR WHETHER SEIT HAS BEEN ADVISED IN ADVANCE OF THE POSSIBILITY OF SUCH DAMAGES. SPECIFICALLY, SEIT IS NOT LIABLE FOR ANY COSTS, SUCH AS LOST PROFITS OR REVENUE, WHETHER DIRECT OR INDIRECT, LOSS OF EQUIPMENT, LOSS OF USE OF EQUIPMENT, LOSS OF SOFTWARE, LOSS OF DATA, COSTS OF SUBSTITUANTS, CLAIMS BY THIRD PARTIES, OR OTHERWISE.

NOTHING IN THIS LIMITED WARRANTY SHALL SEEK TO EXCLUDE OR LIMIT SEIT LIABILITY FOR DEATH OR PERSONAL INJURY RESULTING FROM ITS NEGLIGENCE OR ITS FRAUDULENT MISREPRESENTATION OF TO THE EXTENT THAT IT CANNOT BE EXCLUDED OR LIMITED BY APPLICABLE LAW.

To obtain service under warranty you must obtain a Returned Material Authorization (RMA) number from customer support. Customers with warranty claims issues may access the SEIT worldwide customer support network through the Schneider Electric Web site: www.se.com. Select your country from the country selection drop down menu. Open the Support tab at the top of the web page to obtain information for customer support in your region. Products must be returned with transportation charges prepaid and must be accompanied by a brief description of the problem encountered and proof of date and place of purchase.

Schneider Electric Worldwide Customer Support

Customer support for this or any other Schneider Electric product is available at no charge in any of the following ways:

- Visit the Schneider Electric Web site to access documents in the Schneider Electric Knowledge Base and to submit customer support requests.
 - **www.se.com** (Corporate Headquarters)
Connect to localized Schneider Electric Web sites for specific countries, each of which provides customer support information.
 - **www.se.com/support/**
Global support searching Schneider Electric Knowledge Base and using e-support.
- Contact the Schneider Electric Customer Support Center by telephone or e-mail.
 - Local, country specific centers: go to **www.se.com/support/contact** for contact information.

For information on how to obtain local customer support, contact the Schneider Electric representative or other distributor from whom you purchased your Schneider Electric product.