

sarlam

KALANK

NT 37 016/02

T 1 (Ø 198 mm)

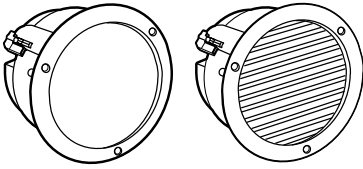

T 2 (Ø 270 mm)

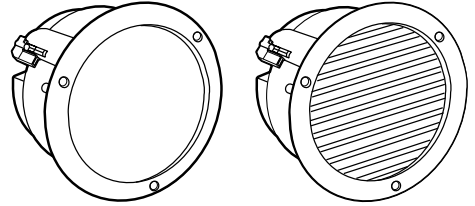

T1 Max.	10 W	1 W 16 Leds
T2 Max.	E27 - 60 W	
T2 Max.	18W	2 x 9W

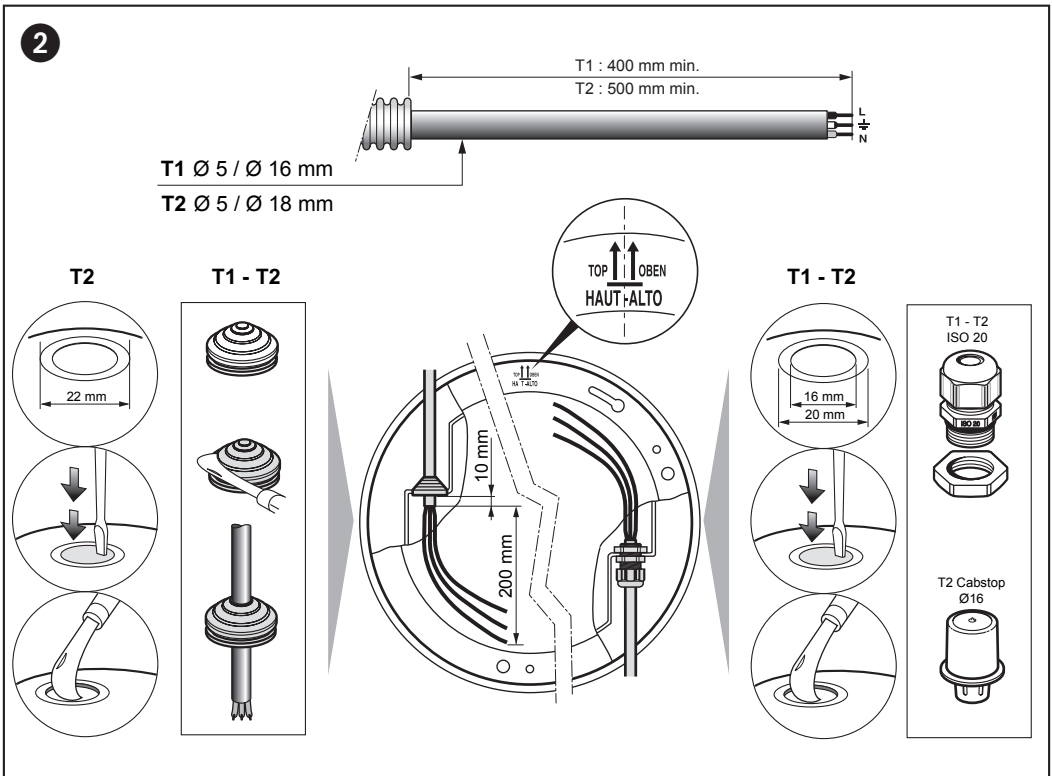
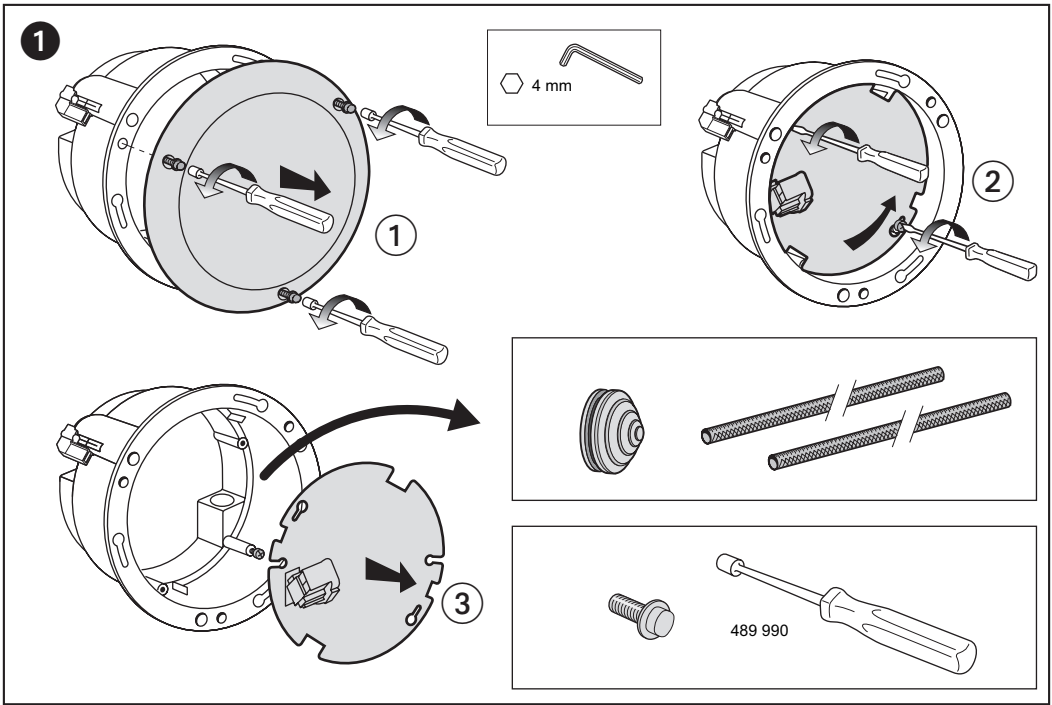

3

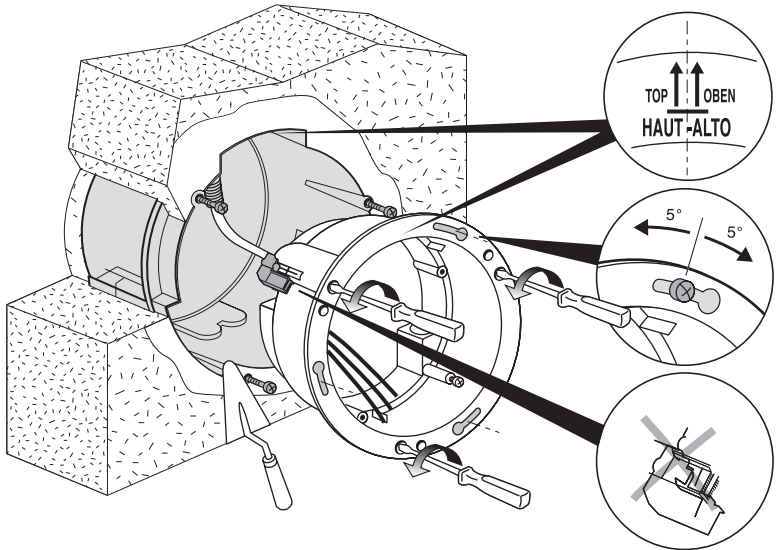
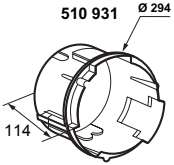
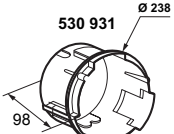

510 920

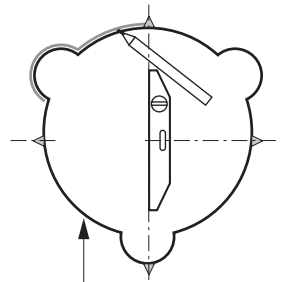
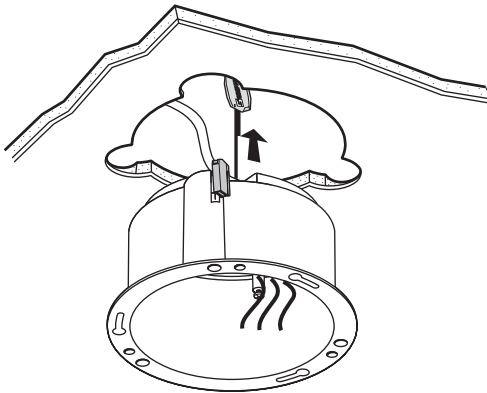

T 1 : \varnothing 170

T 2 : \varnothing 230

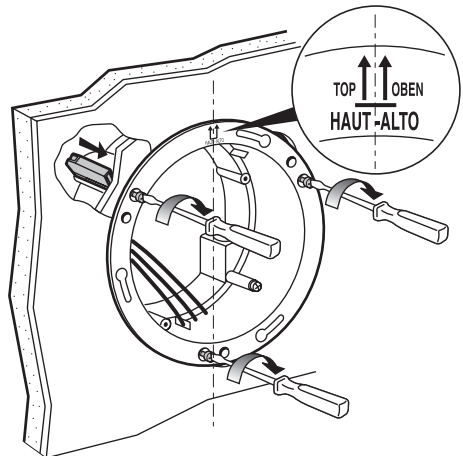
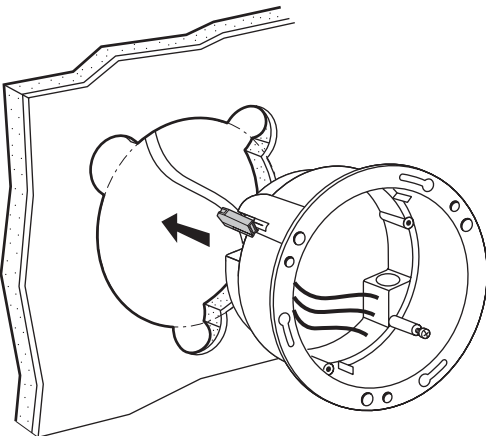

T 1 - T 2

Cl. I

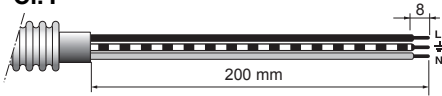

T 2

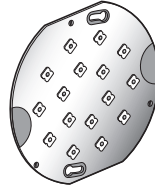
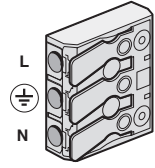
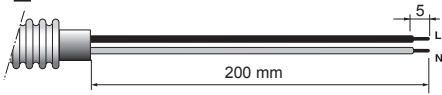

4

