

MR16 CONSTANT CURRENT



OUTPUT RANGE: VIVID SERIES	485 - 580 lumen
BEAM ANGLE RANGE	10°, 25°, 36°
COLOR TEMPERATURE RANGE	2700K, 3000K, 4000K
APPLICATION	LED constant current lamp for indoor applications



POINT SOURCE OPTICS

Exceptional beam control enables unique 10° narrow spot and smooth uniform beams

Single light source, single crisp shadow

VP₃ VIVID COLOR AND VP₃ NATURAL WHITE

VIVID series provides accurate color rendering across the visible spectrum from 400nm to 700nm, with CRI/95, R9/95, Rf/90, Rg/100

Whiteness rendering matches or exceeds that of halogen and incandescent sources at 2700K and 3000K

ENERGY EFFICIENCY AND LONG LIFE

Rated lifetime to L70: 35,000hrs

Warranty: 3yrs or 25,000hrs whichever comes first

Detailed warranty information available at soraalighting.com/resources/legal

CERTIFICATIONS



RoHS



GENERAL SPECIFICATIONS

Form Factor	Operating Temperature	Operating Current	Forward Voltage
Width: 50.1mm (1.97")	Minimum: -40°C (ambient)	Minimum: 20mA	Nominal: 28.4V
Height: 45.5mm (1.79")	Typical: 85°C - 90°C (base)	Typical: 300mA	Range: 25V – 30V
Weight: 44g	Maximum: 90°C (base)	Maximum: 350mA	Power Supply Requirement: 20V – 35V DC*

*Power supply voltage range requirement is related to operation at low current amplitude, for example under current amplitude dimming

HIGHLY COMPATIBLE

Fixture compatibility and driving current are subject to the lamp base temperature. Exceeding maximum ratings for operating and storage temperature will reduce expected life time or destroy the CC MR16 lamp, voiding the lamp warranty. The temperature at the base of the lamp must be measured at the point indicated on this specification sheet.

Geometrically compatible with standard MR16 fixtures

Not recommended for enclosed fixtures or for use with front glass cover

Suitable for damp locations

Compatible with the Soraa SNAP System™

INTENDED USE AND APPLICATIONS

Intended for use in MR16 compatible recessed downlights, track lighting and other indoor applications

Designed to work with external constant current drive

STORAGE CONDITIONS

Maximum storage temperature of 90°C

DIMENSIONS

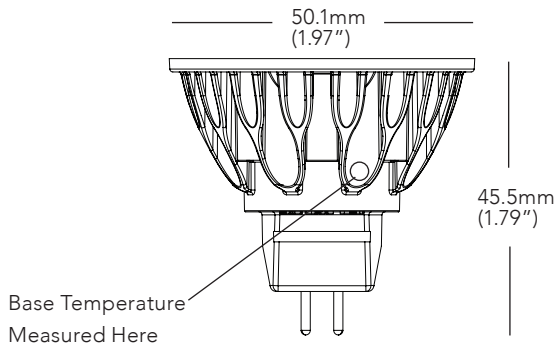

COLOR RENDERING

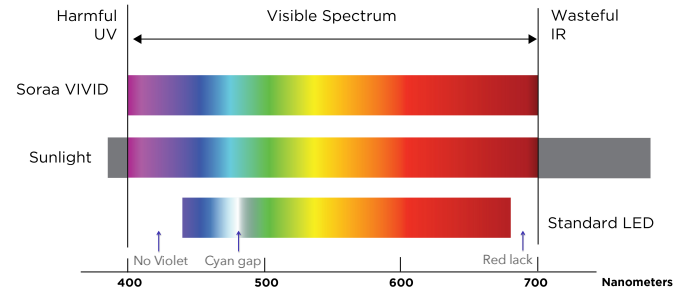

10 DEGREE BEAM

PHOTOMETRICS: 95CRI, 3000K AT 300MA, 85°C

Beam Dia at 50% CBCP (ft)	Field Dia at 10% CBCP (ft)	Foot-candles (% of CBCP)
0.5	0.9	11.1%
1.0	1.8	2.8%
1.6	2.7	1.2%
2.1	3.6	0.7%
2.6	4.5	0.4%

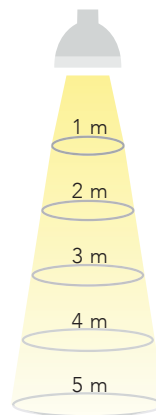

25 DEGREE BEAM

PHOTOMETRICS: 95CRI, 3000K AT 300MA, 85°C

Beam Dia at 50% CBCP (ft)	Field Dia at 10% CBCP (ft)	Foot-candles (% of CBCP)
1.3	2.1	11.1%
2.7	4.1	2.8%
4.0	6.2	1.2%
5.3	8.3	0.7%
6.7	10.3	0.4%

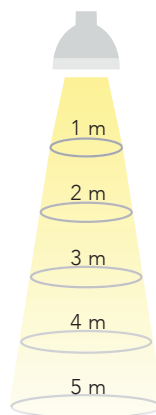

36 DEGREE BEAM

PHOTOMETRICS: 95CRI, 3000K AT 300MA, 85°C

Beam Dia at 50% CBCP (ft)	Field Dia at 10% CBCP (ft)	Foot-candles (% of CBCP)
1.9	3.1	11.1%
3.9	6.1	2.8%
5.8	9.2	1.2%
7.8	12.2	0.7%
9.7	15.3	0.4%

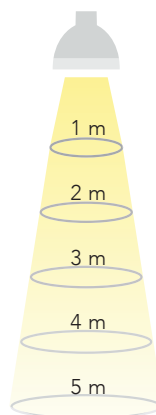

Note: Lux may be calculated by multiplying the peak Intensity of the desired model number by the percentage in the tables above
Footcandle multiplication factors for other CCTs 2700K: 0.93, 4000K: 1.04

SPECIFICATIONS BY MODEL NUMBER* SORAA LED MR16 CONSTANT CURRENT

Model #	Product Code	CCT (K)	Beam Angle	Field Angle	CBCP (Cd)	Total Flux (Lm)	Efficacy (Lm/W)	McA	SNAP
VIVID SERIES									
SM16C-CC1-10D-927-03	01331	2700	10	17	7120	485	57	3	YES
SM16C-CC1-25D-927-03	01333	2700	25	39	2860	515	60	3	-
SM16C-CC1-36D-927-03	01335	2700	36	54	1360	515	60	3	-
SM16C-CC1-10D-930-03	01337	3000	10	17	7700	525	62	3	YES
SM16C-CC1-25D-930-03	01339	3000	25	39	3060	550	65	3	-
SM16C-CC1-36D-930-03	01341	3000	36	54	1460	550	65	3	-
SM16C-CC1-10D-940-03	01343	4000	10	17	8060	550	65	4	YES
SM16C-CC1-25D-940-03	01345	4000	25	39	3220	580	68	4	-
SM16C-CC1-36D-940-03	01347	4000	36	54	1520	580	68	4	-

CCT: Correlated Color Temperature **McA:** White Point Accuracy in McA step **SNAP:** SORAA SNAP System Compatible **EI:** Energy Efficiency Index

*Specifications are at 300mA and 85°C body temperature

TYPICAL FORWARD VOLTAGE CHARACTERISTICS

Current	Body Temperature				
	25°C	45°C	65°C	85°C	105°C
50mA	27.7	27.3	26.9	26.6	26.3
150mA	28.7	28.2	27.8	27.5	27.2
200mA	29.0	28.5	28.2	27.8	27.6
250mA	29.3	28.8	28.5	28.2	27.9
300mA	29.6	29.1	28.8	28.4	28.2

LIGHT OUTPUT NORMALIZED TO 300mA, 85°C

Current	Body Temperature				
	25°C	45°C	65°C	85°C	105°C
50mA	0.19	0.19	0.19	0.18	0.18
150mA	0.55	0.55	0.54	0.53	0.59
200mA	0.72	0.71	0.70	0.69	0.67
250mA	0.89	0.88	0.86	0.85	0.82
300mA	1.04	1.04	1.02	1.00	0.97

SERIES/CCT

COLOR ACCURACY

WHITENESS INDEX

SPECTRAL POWER DISTRIBUTION

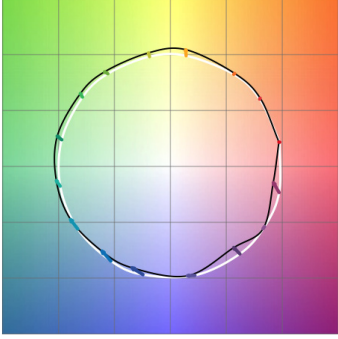
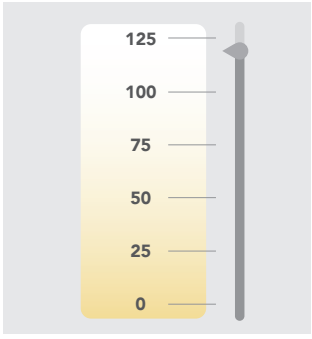
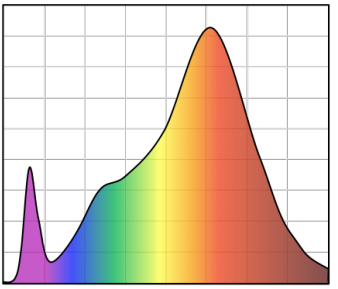
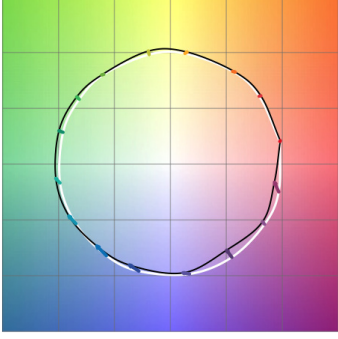
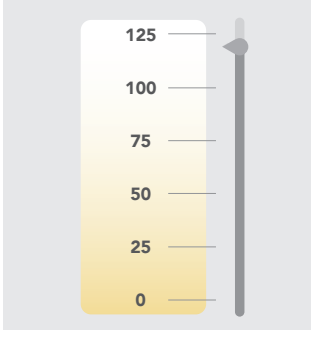
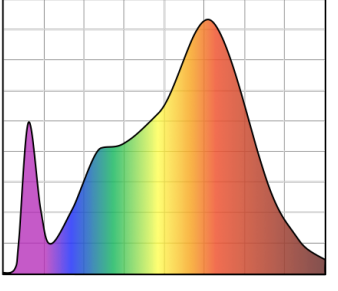
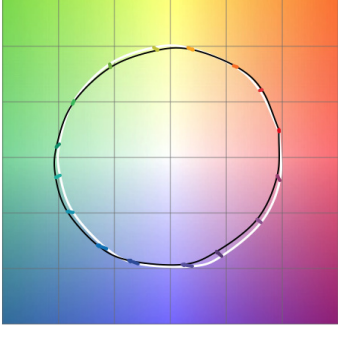
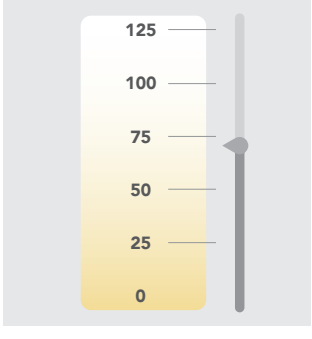
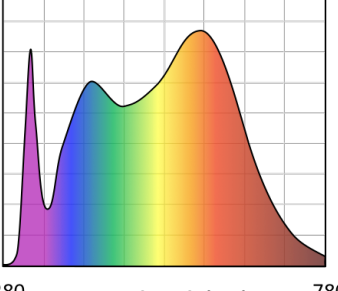
<p>VIVID 2700K</p>	 <p>Rf: 90, Rg: 100, Rfh1: 95</p>	 <p>Rw: 120</p>	 <p>380 Wavelength (nm) 780</p> <p>CRI: 95, R9: 95</p>
<p>VIVID 3000K</p>	 <p>Rf: 90, Rg: 100, Rfh1: 95</p>	 <p>Rw: 120</p>	 <p>380 Wavelength (nm) 780</p> <p>CRI: 95, R9: 95</p>
<p>VIVID 4000K</p>	 <p>Rf: 90, Rg: 100, Rfh1: 95</p>	 <p>Rw: 70</p>	 <p>380 Wavelength (nm) 780</p> <p>CRI: 95, R9: 95</p>