

Product Specifications

The Soraa Arc™ Downlight series combines elegant design with Soraa's unique quality of light to create a dynamic and versatile solution for retail, hospitality, and residential applications. Soraa Arc gets its name from the form of its unique die-cast curved heat sink, which is precisely engineered for optimal thermal performance.

Soraa VIVID™ LED: Soraa Full Spectrum integral LED Light Engine available in 2700K, 3000K, and 4000K with 95 CRI, 95 R9 and 100 Rw. IR and UV free.

Soraa Optics: Soraa optic technology with exceptional beam control and smooth uniform light distribution.

Electrical: 220-240VAC fully integral LED electronic constant current driver (included). Frequency: 50/60Hz Power Factor: 0.93 Wattage: 18W.

Dimming and Flicker: Dimming as low as 1%*; Triac, 0-10V, and ELV dimming standard options. < 30% Flicker. See soraa.com for details.

Installation: Recessed mounting with trimmed or trimless options. 90mm (3.5") ceiling opening recommended.

Optional Trimless Adaptor: Order separately for use with trimless light engines only.

Construction and Finish: Light engine includes die-cast aluminum heat sink designed for optimal thermal management. Collar made of die cast aluminium. Durable non-glare satin finish.

SNAP Trims Construction and Finish: Die-cast aluminum construction. Magnetic snap attachment allows easy tool-free installation and tight ceiling fit. 4 color options available.

Operating Temperature: Minimum -40°C, 25°C typical.

Compliance: CE compliant.

Warranty: Five year warranty. See www.soraa.com.



Simple Installation, Including SNAP™ Trim

Replaceable Light Engine

Soraa Vivid Full Spectrum LED- 95CRI, R9 >95

Flicker-Free Phase Dim, DALI, 0-10V
Dimming as low as 1%*

25,000 hr Lifetime at 70% Lumen Maintenance

5 year Warranty



Full Spectrum



Natural White



CRI 95



R9 95



No IR



No UV



Dimmable



Soraa SNAP Compatible



IC Rated



IP 20



UL LISTED

* see soraa.com/resources/arc_compatibility

90mm LED Wall Wash Recessed Downlight (50mm lens) 220-240VAC

Luminaire Specification Guide

1. Driver

Sample Number: DD50-E-S3

Product Code

DD50 Downlight Driver Kit

Driver

E 220-240VAC Phase Dim
ED 220-240VAC DALI
E10 220-240VAC 0-10V

Region

S3 EU, APAC

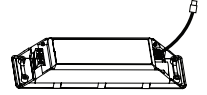

Trimless Adaptor

May be ordered in advance as separate part number

Product Code

DMS50 Downlight Trimless Adaptor Square

DMR50 Downlight Trimless Adaptor Round

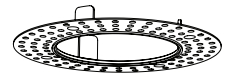

2. Light Engine & Collar

Sample Number: DESW50-927-WW-R-T-W-S3

Product Code

DESW50 Downlight Light Engine Square Wall Wash

DERA50 Downlight Light Engine Round Wall Wash

CRI/CCT

927 95/2700K
930 95/3000K
940 92/4000K

Beam

WW Wall Wash

Mount

R Remodel

Collar

T Trimmed
TL Trimless

Finish

B Black
W White

Region

S3 EU, APAC

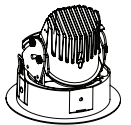

3. SNAP™ Trim

Sample Number: DTSW50-W

Product Code

DTSW50 Downlight Trim Square Wall Wash

DTRW50 Downlight Trim Round Wall Wash

Finish

B Black
W White
S Silver
T Tangerine
C Custom

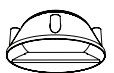

90mm LED Wall Wash Recessed Downlight (50mm lens) 220-240VAC

Light Engine Overview

Output	Color & Optics	Operation	Electrical
Lumens 880-1040	CCT 2700K, 3000K, 4000K	Efficacy 48-58 lm/W	Input Voltage 220-240VAC, 50/60hz
CBCP 2560-8380	CRI 95	Ambient Operating Temperature Minimum -40°C, 25°C typical	Power Factor 0.93
	R9 >95	Lifetime 25,000 hours	Top Rated Power 18W
	SDCM 3-step McA		Dimming 100% - 1% (see soraa.com for performance details*)

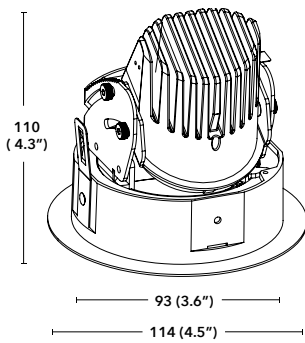

DERW50-T
Downlight Light Engine Round
Wall Wash Trimmed

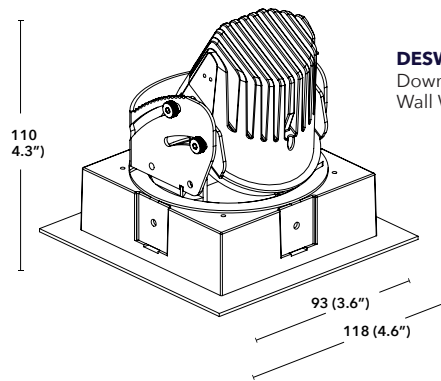

DESW50-T
Downlight Light Engine Square
Wall Wash Trimmed

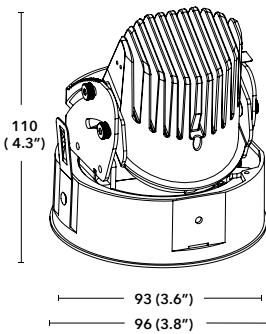

DERW50-TL
Downlight Light Engine Round
Wall Wash Trimless

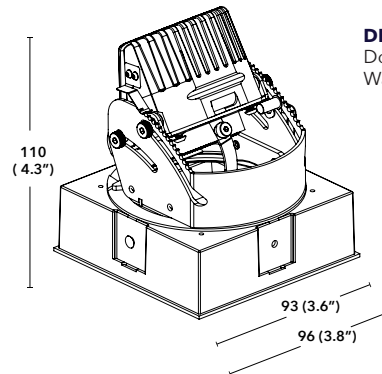

DESW50-TL
Downlight Light Engine Square
Wall Wash Trimless

* soraa.com/resources/arc_compatibility

SNAP Trim Overview

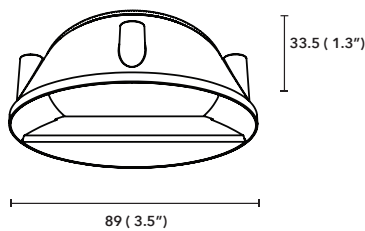

DTRW50 Downlight Trim Round Wall Wash

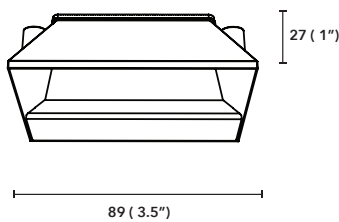

DTSW50 Downlight Trim Square Wall Wash



B Black



W White

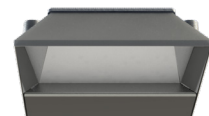

S Silver



T Tangerine

Photometrics

Candlepower

Angle	Across ⊥	45°	Along
0	416	416	416
5	455	438	415
10	483	452	405
15	498	456	391
20	506	453	370
25	497	441	344
30	476	422	316
35	445	395	290
40	400	365	251
45	343	312	213
50	279	257	171
55	225	197	127
60	161	141	87
65	118	95	54
70	87	60	30
75	60	35	14
80	37	19	7
85	22	10	4
90	13	5	3

Coefficients Of Utilization - Zonal Cavity Method
Effective Floor Cavity Reflectance 0.20

rc rw RCR	80				70				50			30			10			0
	70	50	30	10	70	50	30	10	50	30	10	50	30	10	50	30	10	0
0	119	119	119	119	116	116	116	116	111	111	111	106	106	106	102	102	102	100
1	111	107	103	100	108	104	101	98	100	98	95	96	94	92	93	91	90	88
2	102	95	89	84	100	93	88	93	90	85	82	87	83	80	84	81	78	76
3	94	85	78	72	92	84	77	72	81	75	71	78	73	69	76	72	68	66
4	87	77	69	73	85	75	68	63	73	67	62	71	65	61	69	64	60	58
5	81	69	61	55	79	68	61	55	66	60	55	64	59	54	63	58	53	52
6	75	63	55	49	73	62	55	49	60	54	49	59	53	48	57	52	48	46
7	70	58	50	44	68	57	49	44	55	49	44	54	48	43	53	47	43	41
8	65	53	45	40	64	52	45	40	51	44	39	50	44	39	49	43	39	37
9	61	49	41	36	60	48	41	36	47	41	36	46	40	36	45	40	36	34
10	58	45	38	33	56	45	38	33	44	37	33	43	37	33	42	37	33	31

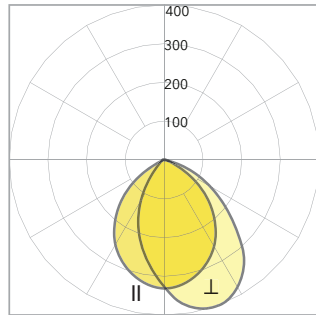

Zonal Lumen Summary

Zone	Lumens	% Fixture
0-30	313	37
0-40	493	58
0-60	762	90
0-90	850	100
0-180	850	100

Base Configuration

CCT: 3000K

Scaling

2700K 0.95
4000K 1.04

Layout Illuminance Calculations

Spacing (m) Distance (m)	0.9		0.9		0.9		1.2		1.2		1.2		1.5		1.5	
	0.9		1.2		1.5		0.9		1.2		1.5		1.2		1.5	
	Illuminance (lx)		Illuminance (lx)		Illuminance (lx)		Illuminance (lx)		Illuminance (lx)		Illuminance (lx)		Illuminance (lx)		Illuminance (lx)	
Dist from Ceiling (m)	Below Fixture	Between Fixtures	Below Fixture	Between Fixtures	Below Fixture	Between Fixtures	Below Fixture	Between Fixtures	Below Fixture	Between Fixtures	Below Fixture	Between Fixtures	Below Fixture	Between Fixtures	Below Fixture	Between Fixtures
0.25	85	82	48	47	34	33	73	54	38	36	26	26	34	27	22	21
0.5	169	171	96	95	63	61	140	116	74	72	48	48	64	54	40	38
0.75	231	235	143	141	94	91	186	172	108	109	71	71	93	84	58	58
1	243	250	178	175	123	119	191	183	135	137	95	94	113	109	77	77
1.25	220	223	187	182	146	138	170	169	144	146	112	110	118	114	90	91
1.5	186	190	179	176	153	146	144	145	139	143	119	117	114	114	98	97
1.75	153	157	163	160	149	144	123	123	126	128	118	117	106	103	95	98
2	133	132	144	141	139	137	105	105	114	115	113	111	94	95	94	95
2.25	115	114	130	127	133	128	95	91	104	104	109	105	87	86	88	88
2.5	103	104	118	115	122	121	85	84	96	93	101	97	80	79	83	83
2.75	96	94	111	108	113	111	78	81	91	88	97	96	76	77	80	79

Soraa Arc™ Color and Whiteness Rendering

CCT	CRI	R9	Rf	Rg	Rfh1	Rw	McA
2700	95	95	90	100	95	120	3
3000	95	95	90	100	95	120	3

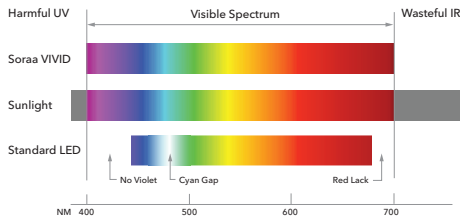

Soraa has engineered the perfect balance between color rendering and white rendering. Soraa's core technology uses a violet LED emitter as the basis for full spectrum light. This allows both Vivid™ color rendering and Natural White™ white rendering, which creates whiteness by exciting fluorescing agents with violet radiation, without the harmful effect of UV.

Rf: The TM-30 metric for color fidelity (similarity to colors under natural light), a more accurate version of the CRI Ra. Rf is 100 for natural light.

Rg: The TM-30 metric for color gamut (whether colors are more saturated than under natural light). Rg is 100 for natural light.

Rfh1: The TM-30 metric for color fidelity for red tones. Rfh1 is a more accurate version of the CRI R9. Rfh1 is 100 for natural light.

Rw: The Soraa-developed metric for white fidelity. Rw measures the magnitude of excitation of whitening agents within white materials. Rw is 100 for natural light.

2700K

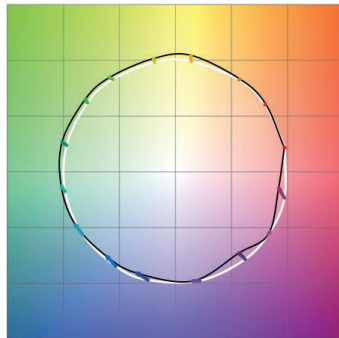

Rf: 90, Rg: 100, Rfh1: 95

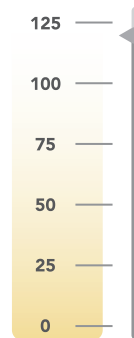

Rw: 120

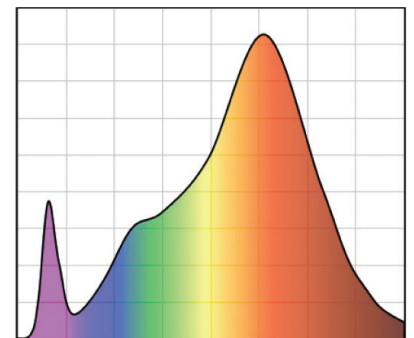

CRI: 95, R9: 95

3000K

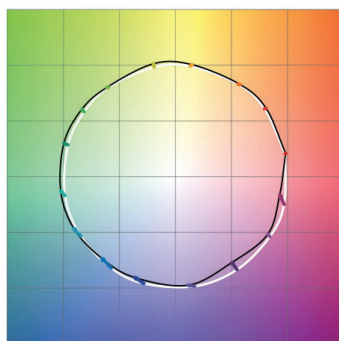

Rf: 90, Rg: 100, Rfh1: 95

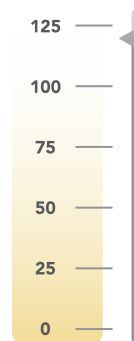

Rw: 120

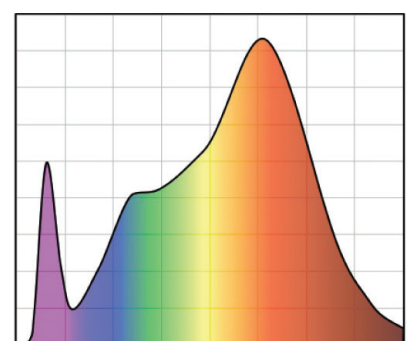

CRI: 95, R9: 95

4000K

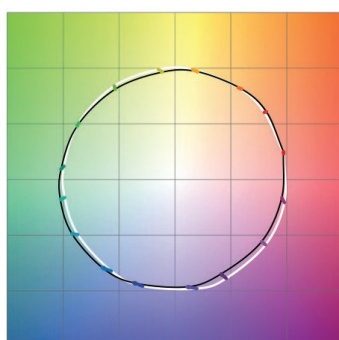

Rf: 90, Rg: 100, Rfh1: 95

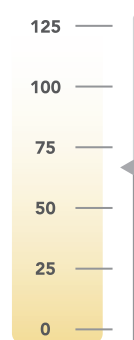

Rw: 70

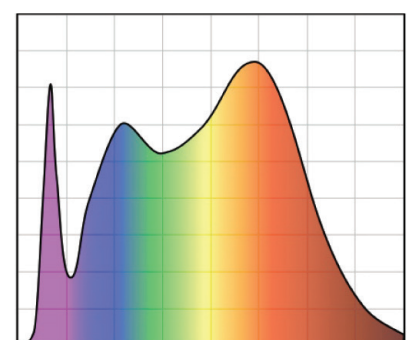

CRI: 95, R9: 95