

Product Specifications

The Soraa Arc™ Downlight series combines elegant design with Soraa's unique quality of light to create a dynamic and versatile solution for retail, hospitality, and residential applications. Soraa Arc gets its name from the form of its unique die-cast curved heat sink, which is precisely engineered for optimal thermal performance.

Soraa VIVID™ LED: Soraa Full Spectrum integrated LED Light Engine available in 2700K, 3000K, and 4000K with 95 CRI, 95 R9 and 100 Rw. IR and UV free.

Soraa Optics: Soraa optic technology with exceptional beam control and smooth uniform light distribution. The 15° beam versions are compatible with all Soraa SNAP™ accessories.

Electrical: 220-240VAC fully integrated LED electronic constant current driver (included, nom. 550mA). Frequency: 50/60Hz Power Factor: 0.93 Wattage: 18W.

Dimming: Dimming as low as 1%, Triac phase dim, 0-10V and DALI dimming. See Soraa.com for details.

Installation: Recessed mounting with trimmed or trimless options. 93mm ceiling opening recommended. Required installation depth 115mm. Thickness of plasterboard material: 12-30mm.

Optional Trimless Adaptor: Order separately for use with trimless light engines only.

Construction and Finish: Light engine includes die-cast aluminum heat sink designed for optimal thermal management. Collar made of die cast aluminium. Durable non-glare satin finish.

SNAP Trims Construction and Finish: Die-cast aluminum construction. Magnetic snap attachment allows easy tool-free installation and tight ceiling fit. 4 color options available.

Operating Temperature: Minimum -40°C, 25°C typical.

Compliance: CE compliant.

Warranty: Five year warranty. See www.soraa.com.



Simple Installation, Including SNAP™ Trim

Replaceable Light Engine

Soraa Vivid Full Spectrum LED- 95CRI, R9 >95, Rw 100

Flicker-Free Phase Dim, DALI, 0-10V
Dimming as low as 1%*

25,000 hr Lifetime at 70% Lumen Maintenance

5 year Warranty



* see soraa.com/resources/arc_compatibility

Luminaire Specification Guide

1. Driver

Sample Number: DD50-E-S3

Product Code

DD50 Downlight Driver Kit

Driver

E 220-240VAC Phase Dim
ED 220-240VAC DALI
E10 220-240VAC 0-10V

Region

S3 EU, APAC

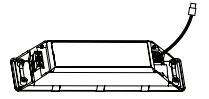

Trimless Adaptor

Sample Number: DMS50

Trimless Adaptor required for trimless installation.
May be ordered in advance as separate part number.

Product Code

DMS50 Downlight Trimless Adaptor Square
DMR50 Downlight Trimless Adaptor Round

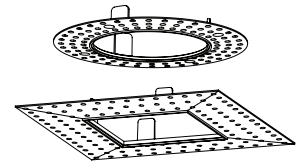

2. Light Engine & Collar

Sample Number: DESF50-15D-927-R-T-W-S3

Product Code

DESF50 Downlight Light Engine Square Fixed
DERF50 Downlight Light Engine Round Fixed

Beam

15D 15° Narrow Spot (SNAP Compatible) 
25D 25° Narrow Flood
36D 36° Flood

CRI/CCT

927 95/2700K
930 95/3000K
940 92/4000K

Mount

R Remodel

Collar

T Trimmed
TL Trimless

Finish

B Black
W White

Region

S3 EU, APAC

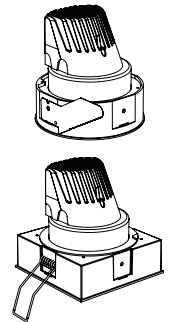

3. SNAP™ Trim

Sample Number: DTSF50-W

Product Code

DTSF50 Downlight Trim Square Fixed
DTRF50 Downlight Trim Round Fixed
DTSFW50 Downlight Trim Square Fixed IP44 (Solite Lens)
DTRFW50 Downlight Trim Round Fixed IP44 (Solite Lens)

Finish

B Black
W White
S Silver
T Tangerine
C Custom

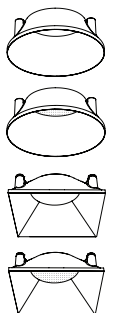

Light Engine Overview

Output	Color & Optics	Operation	Electrical
Lumens 880-1040	CCT 2700K, 3000K, 4000K	Efficacy 48-58 lm/W	Input Voltage 220-240VAC, 50/60hz
CBCP 2560-8380	CRI 95	Ambient Operating Temperature Minimum -40°C, 25°C typical	Power Factor 0.93
	R9 >95	Lifetime 25,000 hours	Current 550mA, nom
	SDCM 3-step McA		Top Rated Power 18W
	Beams 15°, 25°, 36°		Dimming 100% - 1% (see soraa.com for performance details*)

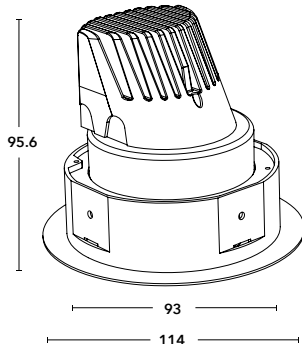

DERF50-T
Downlight Light Engine Round
Fixed Trimmed

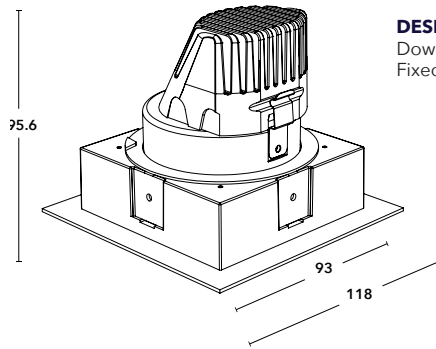

DESF50-T
Downlight Light Engine Square
Fixed Trimmed

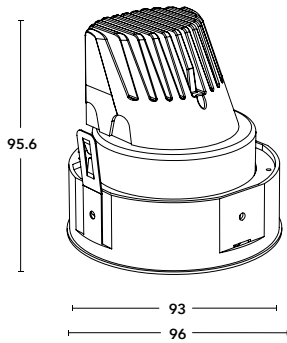

DERF50-TL
Downlight Light Engine Round
Fixed Trimless

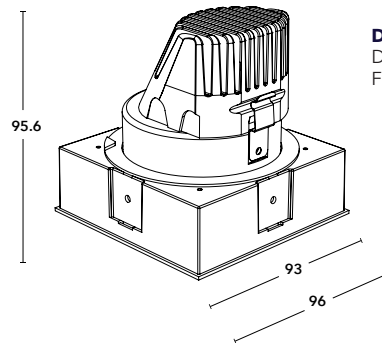

DESF50-TL
Downlight Light Engine Square
Fixed Trimless

*soraa.com/resources/arc_compatibility

SNAP Trim Overview

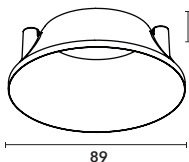

DTRF50
Downlight Trim
Round Fixed

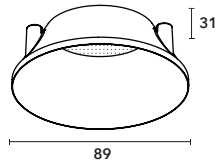

DTRFW50
Downlight Trim
Round Fixed IP44
(Solite Lens)



B Black



W White

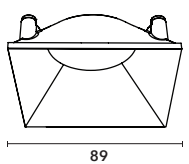

DTSF50
Downlight Trim
Square Fixed

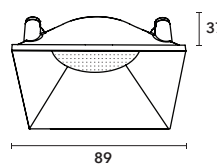

DTSFW50
Downlight Trim Square
Fixed IP44
(Solite Lens)

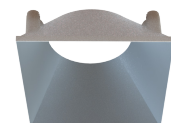

S Silver



T Tangerine

Photometrics

Data is shown for 3000K
FC Multipliers: 2700K: 0.95; 4000K: 1.0

Spot 15°

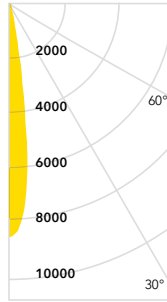

W	CCT	Lm	CBCP
18	2700	880	7650 cd
18	3000	930	8080 cd
18	4000	965	8380 cd

Candelas at Nadir

0°	8165
5°	6573
15°	628
25°	151
35°	87
45°	46

Narrow Flood 25°

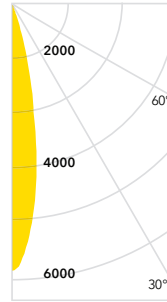

W	CCT	Lm	CBCP
18	2700	950	5510 cd
18	3000	1000	5800 cd
18	4000	1040	6030 cd

Candelas at Nadir

0°	5870
5°	4970
15°	1562
25°	128
35°	37
45°	25

Flood 36°

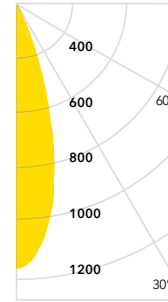

W	CCT	Lm	CBCP
18	2700	950	2560 cd
18	3000	1000	2700 cd
18	4000	1040	2800 cd

Candelas at Nadir

0°	2771
5°	2683
15°	1627
25°	408
35°	82
45°	32



Soraa SNAP
Compatible

Aiming Angles

L and W refer to outer points where footcandles drop to 50% of maximum. FC refers to initial footcandles at the center of the beam.

Key (distances in metres)

- L Beam Distance
- D Distance
- W Beam Width
- FC Footcandles
- C Distance to Center Beam

0° Horizontal

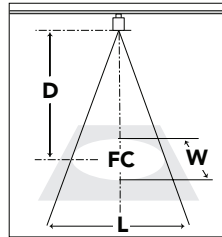

30° Horizontal

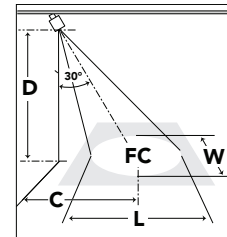

30° Vertical

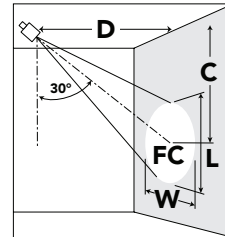

	D	FC	L	W	D	C	FC	L	W	D	C	FC	L	W
Spot 15°	6	226	1.6	1.6	6	3.7	151	2.1	1.8	2	3.7	307	1.7	0.9
	8	127	2.1	2.1	8	4.8	86	2.8	2.3	3	5.4	140	2.5	1.3
	10	82	2.6	2.6	10	5.9	55	3.4	2.9	4	7.1	79	3.3	1.8
	12	57	3.1	3.1	12	7.0	39	4.1	3.5	5	8.7	51	4.1	2.1
Narrow Flood 25°	6	164	2.2	2.2	6	3.6	109	2.9	2.5	2	3.9	239	2.1	1.2
	8	93	2.9	2.9	8	4.8	62	3.8	3.3	3	5.7	108	3.1	1.8
	10	61	3.6	3.6	10	6.0	41	4.6	4.1	4	7.5	62	4.1	2.4
	12	43	4.3	4.3	12	7.1	28	5.5	4.9	5	9.3	40	5.1	2.9
Flood 36°	6	78	3.3	3.2	6	3.8	57	3.8	3.5	2	4.2	152	2.1	1.5
	8	45	4.3	4.2	8	5.0	32	5.0	4.6	3	6.0	68	3.2	2.2
	10	29	5.3	5.3	10	6.1	21	6.2	5.5	4	7.7	39	4.2	3.0
	12	21	6.2	6.2	12	7.1	15	7.5	6.6	5	9.3	25	5.1	3.6

Soraa Arc™ Color and Whiteness Rendering

CCT	CRI	R9	Rf	Rg	Rfh1	Rw	McA
2700	95	95	90	100	95	120	3
3000	95	95	90	100	95	120	3
4000	95	95	90	100	95	70	4

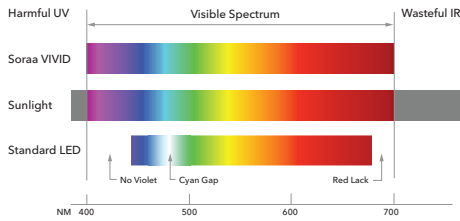

Soraa has engineered the perfect balance between color rendering and white rendering. Soraa's core technology uses a violet LED emitter as the basis for full spectrum light. This allows both Vivid™ color rendering and Natural White™ white rendering, which creates whiteness by exciting fluorescing agents with violet radiation, without the harmful effect of UV.

Rf: The TM-30 metric for color fidelity (similarity to colors under natural light), a more accurate version of the CRI Ra. Rf is 100 for natural light.

Rg: The TM-30 metric for color gamut (whether colors are more saturated than under natural light). Rg is 100 for natural light.

Rfh1: The TM-30 metric for color fidelity for red tones. Rfh1 is a more accurate version of the CRI R9. Rfh1 is 100 for natural light.

Rw: The Soraa-developed metric for white fidelity. Rw measures the magnitude of excitation of whitening agents within white materials. Rw is 100 for natural light.

2700K

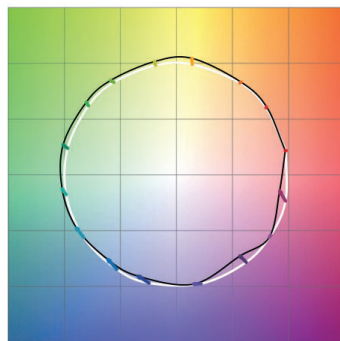

Rf: 90, Rg: 100, Rfh1: 95

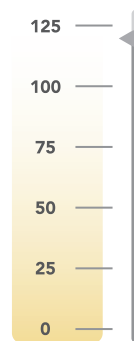

Rw: 120

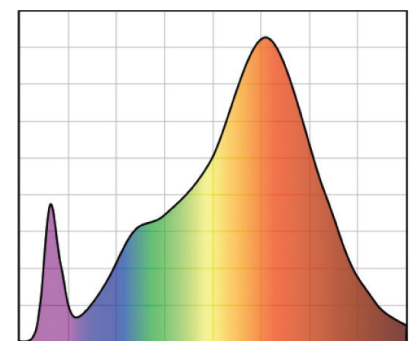

CRI: 95, R9: 95

3000K

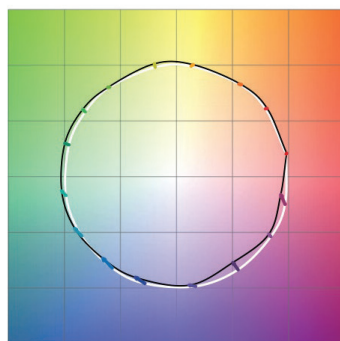

Rf: 90, Rg: 100, Rfh1: 95

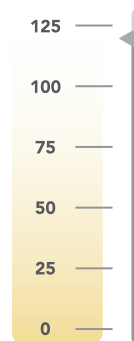

Rw: 120

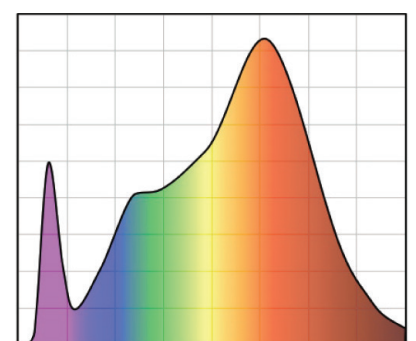

CRI: 95, R9: 95

4000K

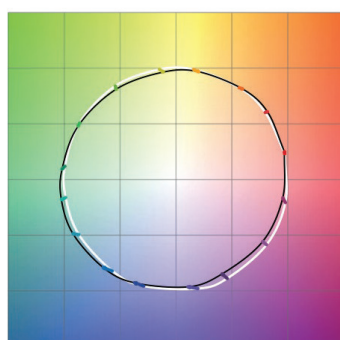

Rf: 90, Rg: 100, Rfh1: 95

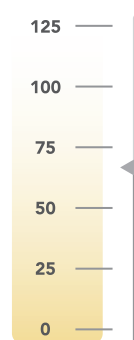

Rw: 70

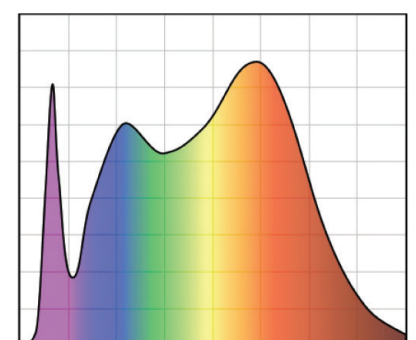

CRI: 95, R9: 95