

The Soraa Arc™ Adjustable luminaire combines elegant design with Soraa's unique quality of light to create a dynamic and versatile solution for retail, hospitality, and residential applications. Soraa Arc gets its name from its unique die-cast curved heat sink, which features a form carefully engineered for optimal thermal performance. Soraa Arc is compatible with the Soraa SNAP System™, which allows you to shape beams, shift color, and more - in a snap.

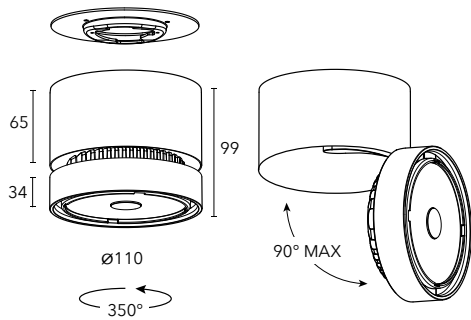

Soraa VIVID™ LED

Soraa Full Spectrum integral LED Light Engine available in 2700K, 3000K, and 4000K with 95 CRI and 95 R9. IR and UV free.

Soraa Optics

Soraa optic technology with exceptional beam control and smooth uniform light distribution. The 9° beam version is compatible with Soraa SNAP System accessories.

Construction and Finish

Light engine is made of die cast aluminium, transformer case from extruded aluminum. Durable satin finish. Custom colors available. Tilt: 0-90°, rotation: 350°.

Applications

Suitable for damp or dry locations. For interior use only.

Installation

Surface mounting with trim ring (included) attached to ceiling.

Electrical

220-240VAC integrated electronic constant current LED driver (included).
Frequency: 50/60Hz
Power Factor: 0.93
Wattage: 20W
Protection: Class 1

Dimming

Dimmable to <1%
Phase dimming standard
Visit www.soraa.com for details

Operating Temperature

Minimum -40°C, 25°C typical.

Accessories

Luminaire accommodates both Arc accessories and Soraa SNAP System simultaneously.

Compliance

CE Compliant. Rated for damp locations.

Warranty

Five year warranty. See www.soraa.com.

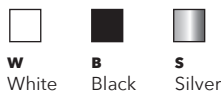

Build Your Luminaire Sample Number: ARA100-25D-927-E-S-W

Series	Beam & Wattage	CCT	Driver	Mounting	Finish	Region
ARA100 Soraa Arc Adjustable, 100mm	09D 9° Narrow Spot	927 2700K	ED 220-240VAC DALI	S Surface	B Black	S3 EU, APAC
	25D 25° Narrow Spot	930 3000K	EH1 220-240VAC Triac & ELV, 0-10V		W White	
	36D 36° Flood	940 4000K			S Silver	
	60D 60° Wide Flood				C Custom	

Photometrics - Soraa Arc™ 100mm

Data is shown for 3000K, for 2700K multiply Lux by 0.95, for 4000K by 1.04.

Narrow Spot 9°

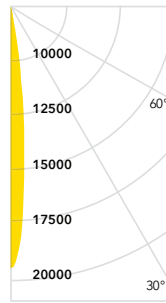

W	CCT	Lm	CBCP
20	2700	950	17500 cd
20	3000	1000	18500 cd
20	4000	1040	19240 cd

Candelas at Nadir

0°	20732
5°	9736
15°	437
25°	171
35°	106
45°	48



Soraa SNAP
Compatible

Narrow Flood 25°

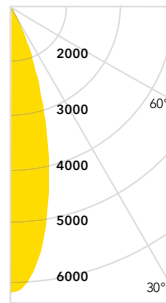

W	CCT	Lm	CBCP
20	2700	995	5770 cd
20	3000	1050	6090 cd
20	4000	1090	6320 cd

Candelas at Nadir

0°	5689
5°	4891
15°	1558
25°	165
35°	52
45°	36

Flood 36°

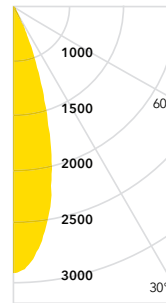

W	CCT	Lm	CBCP
20	2700	995	2680 cd
20	3000	1050	2830 cd
20	4000	1090	2940 cd

Candelas at Nadir

0°	2939
5°	2759
15°	1608
25°	427
35°	93
45°	46

Wide Flood 60°

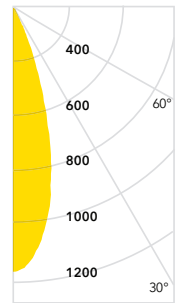

W	CCT	Lm	CBCP
20	2700	995	1090 cd
20	3000	1050	1150 cd
20	4000	1090	1190 cd

Candelas at Nadir

0°	958
5°	953
15°	905
25°	701
35°	342
45°	108

Aiming Angles

L and W refer to outer points where lux drops to 50% of maximum. LX refers to initial lux at the center of the beam.

Key (distances in metres)

L Beam Distance **LX** Lux
D Distance **C** Distance to Center Beam
W Beam Width

0° Horizontal

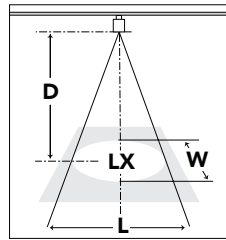

30° Horizontal

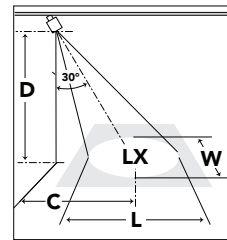

30° Vertical

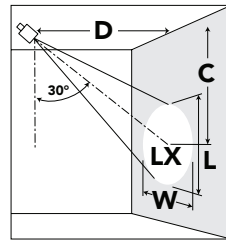

60° Vertical

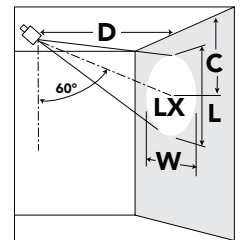

	D	LX	L	W	D	C	LX	L	W	D	C	LX	L	W	D	C	LX	L	W
Narrow Spot 9°	1.8	5985	0.3	0.3	1.8	1.1	4090	1.6	1.4	0.6	1.1	6997	1.4	0.7	0.6	0.4	29773	0.2	0.4
	2.4	3466	0.4	0.4	2.4	1.5	2293	2.2	1.9	0.9	1.6	3197	2.1	1.0	0.9	0.6	14843	0.2	0.6
	3.0	2228	0.5	0.5	3.0	1.8	1464	2.7	2.3	1.2	2.1	1841	2.7	1.4	1.2	0.8	8686	0.3	0.8
	3.7	1561	0.6	0.6	3.7	2.1	1044	3.2	2.8	1.5	2.6	1195	3.4	1.7	1.5	1.0	5705	0.3	1.0
Spot 15°	1.8	1690	0.7	0.7	1.8	1.1	1130	2.1	1.8	0.6	1.2	2465	1.7	0.9	0.6	0.4	9849	0.3	0.9
	2.4	947	0.9	0.9	2.4	1.5	646	2.8	2.3	0.9	1.7	1109	2.5	1.3	0.9	0.6	4478	0.4	1.3
	3.0	614	1.1	1.1	3.0	1.8	420	3.4	2.9	1.2	2.3	624	3.3	1.8	1.2	0.8	2540	0.6	1.7
	3.7	431	1.3	1.3	3.7	2.2	291	4.1	3.5	1.5	2.8	420	4.1	2.1	1.5	1.0	1636	0.7	2.1
Narrow Flood 25°	1.8	883	1.0	1.0	1.8	1.2	614	2.9	2.5	0.6	1.3	1625	2.1	1.2	0.6	0.4	5414	0.4	1.2
	2.4	495	1.3	1.3	2.4	1.5	344	3.8	3.3	0.9	1.8	732	3.1	1.8	0.9	0.6	2433	0.6	1.8
	3.0	323	1.6	1.6	3.0	1.9	226	4.6	4.1	1.2	2.3	409	4.1	2.4	1.2	0.8	1378	0.8	2.3
	3.7	226	1.9	1.9	3.7	2.2	161	5.5	4.9	1.5	2.8	269	5.1	2.9	1.5	1.0	893	1.0	2.9
Flood 36°	1.8	291	1.8	1.8	1.8	1.3	248	3.8	3.5	0.6	1.3	1033	2.1	1.5	0.6	0.5	2153	0.5	1.9
	2.4	172	2.3	2.3	2.4	1.6	140	5.0	4.6	0.9	1.8	474	3.2	2.2	0.9	0.7	969	0.8	2.7
	3.0	108	2.9	2.9	3.0	1.9	97	6.2	5.5	1.2	2.2	258	4.2	3.0	1.2	1.0	549	1.0	3.7
	3.7	75	3.2	3.2	3.7	2.0	65	7.5	6.6	1.5	2.5	172	5.1	3.6	1.5	1.2	355	1.2	4.5

Soraa Arc™ Color and Whiteness Rendering

CCT	CRI	R9	Rf	Rg	Rfh1	Rw	McA
2700	95	95	90	100	95	120	3
3000	95	95	90	100	95	120	3
4000	95	95	90	100	95	70	4

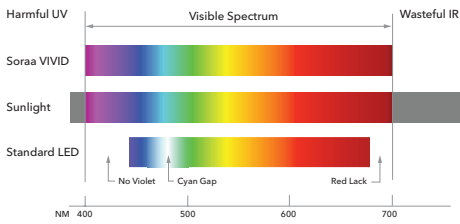

Soraa has engineered the perfect balance between color rendering and white rendering. Soraa's core technology uses a violet LED emitter as the basis for full spectrum light. This allows both Vivid™ color rendering and Natural White™ white rendering, which creates whiteness by exciting fluorescing agents with violet radiation, without the harmful effect of UV.

Rf: The TM-30 metric for color fidelity (similarity to colors under natural light), a more accurate version of the CRI Ra. Rf is 100 for natural light.

Rg: The TM-30 metric for color gamut (whether colors are more saturated than under natural light). Rg is 100 for natural light.

Rfh1: The TM-30 metric for color fidelity for red tones. Rfh1 is a more accurate version of the CRI R9. Rfh1 is 100 for natural light.

Rw: The Soraa-developed metric for white fidelity. Rw measures the magnitude of excitation of whitening agents within white materials. Rw is 100 for natural light.

2700K

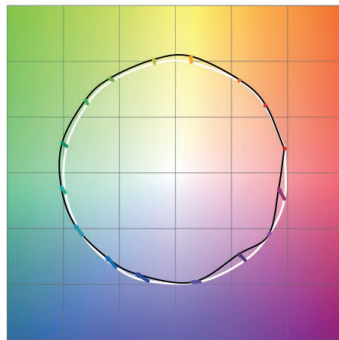

Rf: 90, Rg: 100, Rfh1: 95

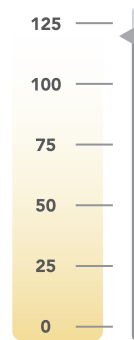

Rw: 120

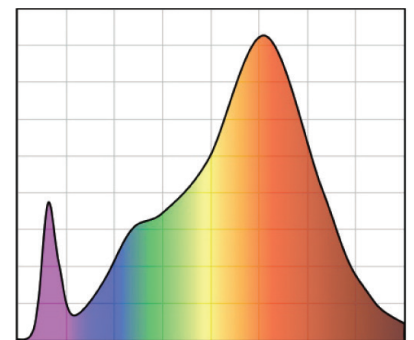

CRI: 95, R9: 95

3000K

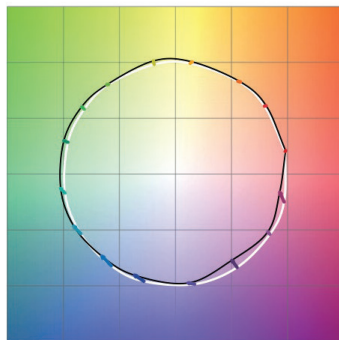

Rf: 90, Rg: 100, Rfh1: 95

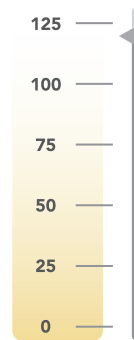

Rw: 120

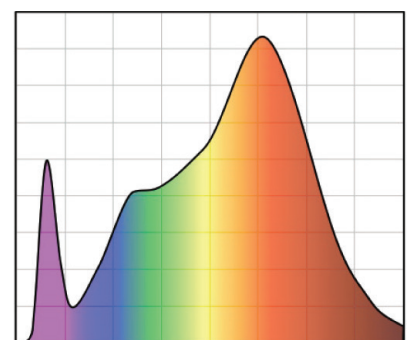

CRI: 95, R9: 95

4000K

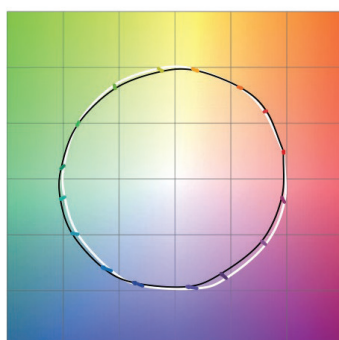

Rf: 90, Rg: 100, Rfh1: 95

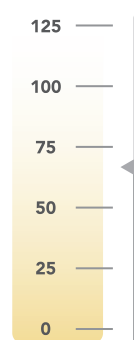

Rw: 70

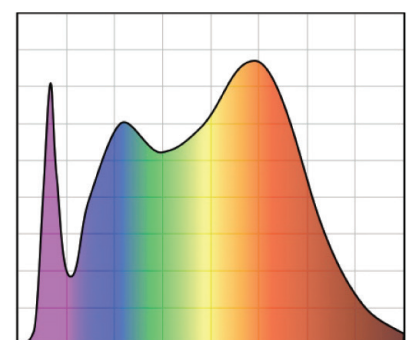

CRI: 95, R9: 95