

HITACHI

Ducted split air conditioning

Cooling & Heating

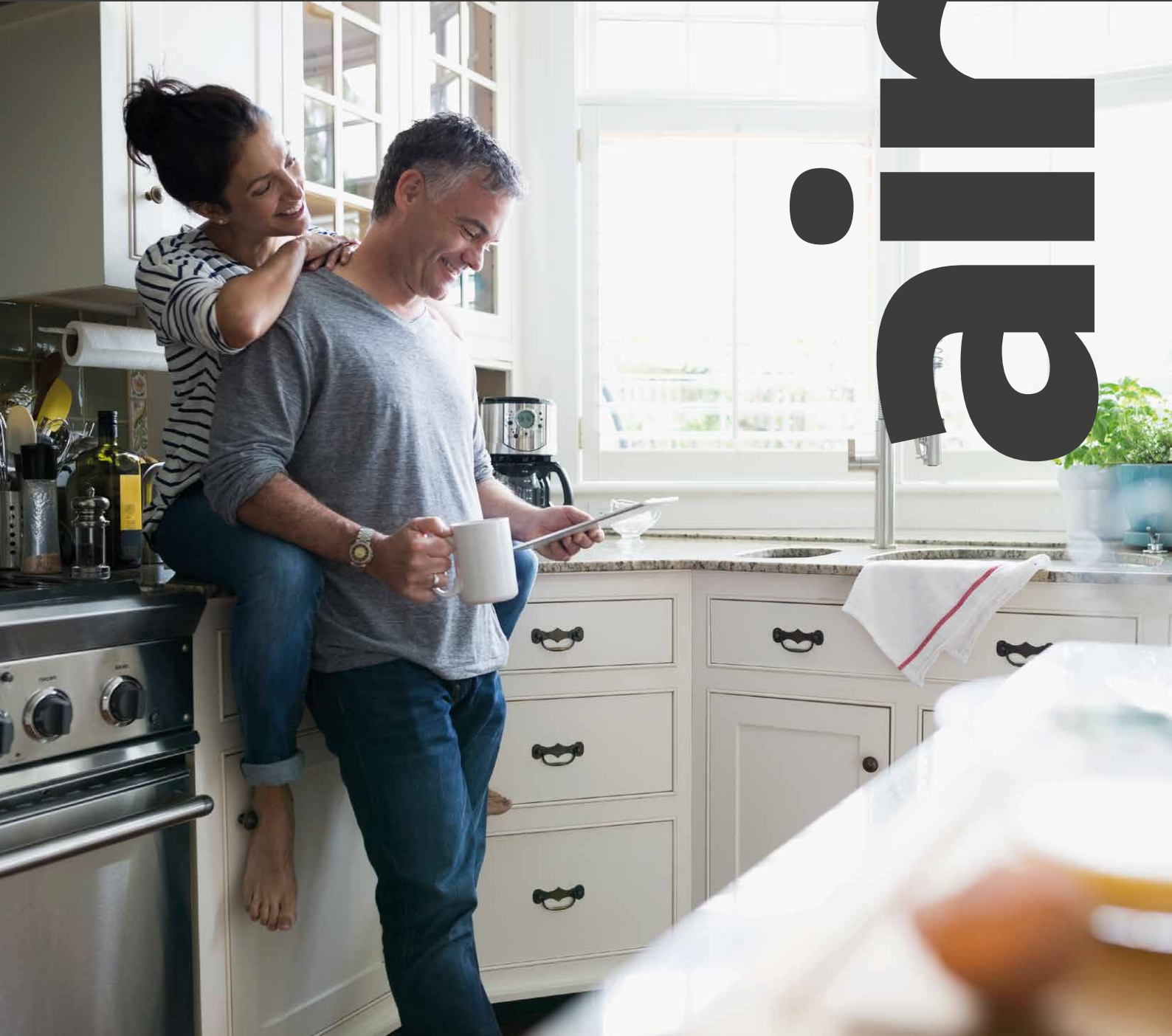

Split

Creating truly comfortable living spaces

We want to help you find the air conditioner that best suits your lifestyle. Our partnership with **temperzone** combines innovative global products with local knowledge and support to meet your needs faster, smarter and more responsibly than ever before.

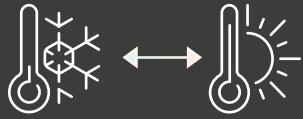

WIDE AMBIENT OPERATING RANGE
-15°C IN WINTER*
46°C IN SUMMER



A++
COOLING & HEATING
EFFICIENCY



5 YEAR
WARRANTY



QUIET
CONTROL

* RAD models -15°C in winter / RPI models -20°C in winter.



The best option for your home

Featuring a lightweight, compact design, our ducted one-to-one systems are the ideal option when installation spaces are tight and challenging.

FLEXIBILITY

Incorporating the power of DC technology, Hitachi's ducted range offers stepless inverter control and the ability to achieve superior operating efficiency.

Ranging in capacity from 5kW to 16kW, we deliver the level of comfort, convenience, and reliability that you've come to expect from Hitachi.

COMPACT DESIGN

Offering great flexibility when negotiating constrained or limited ceiling cavities, it offers a simple yet highly effective air conditioning solution.

Thanks to a unique condenser fan design, outdoor noise levels are also extremely low, making them an ideal choice for use in highly built-up areas. They also feature a unique heat exchanger fan design that increases the unit's heating capacity in cold conditions.



Advancements in technology



Key areas we have developed

COMPACT AND LIGHT

Downsizing has led to a dramatic reduction in the footprint of the range compared with previous models. This has made installation easier and improved maintenance access.

OUTDOOR UNITS

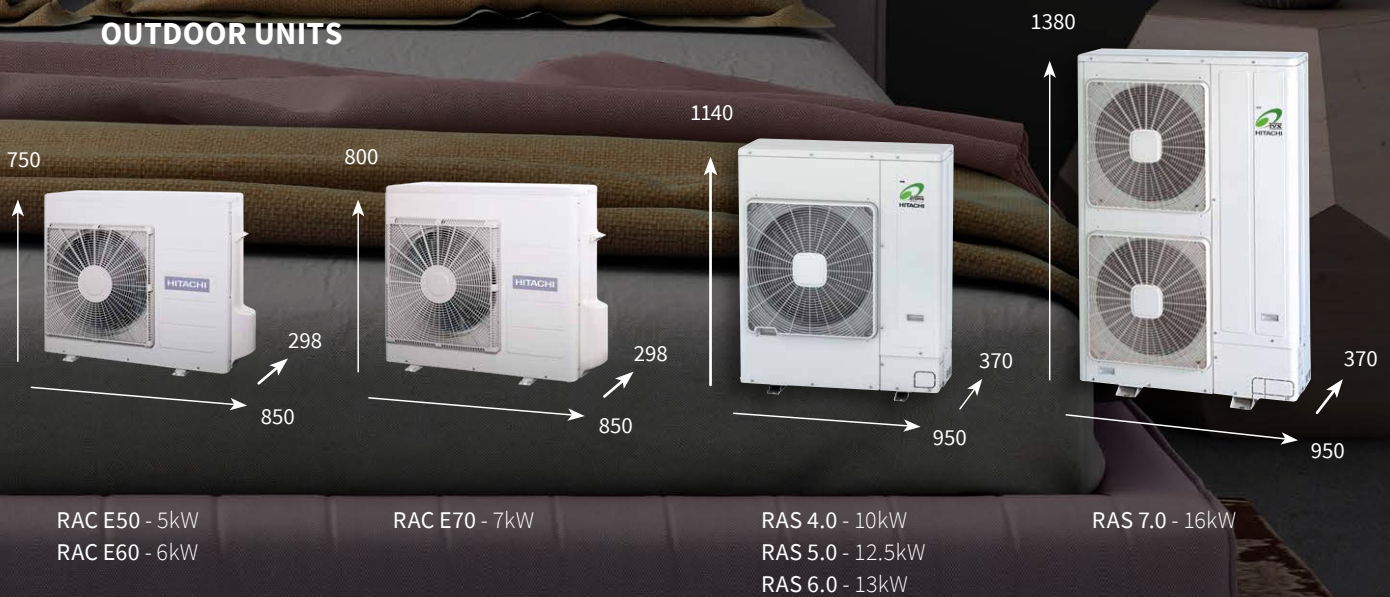

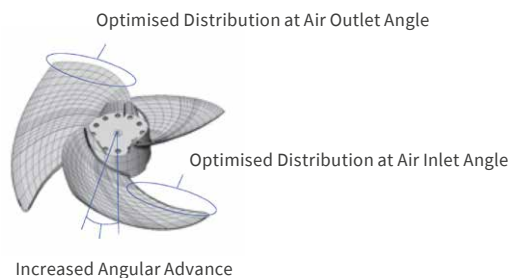
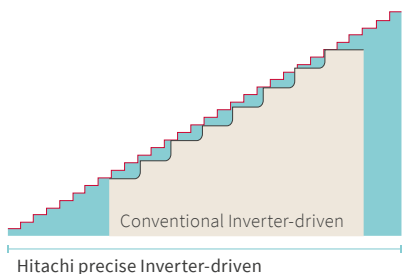

PRECISE INVERTER CONTROL

The operating speed of the compressor’s DC motor can be adjusted continuously in 1Hz increments and in free relation to the variability of system capacity.

QUIET OPERATION - SUPER HIGH-STREAM FAN

Advancements in the blade design and optimisation of the inlet and outlet angles have led to an increase in efficiency while still maintaining low operating noise levels.

DC INVERTER TECHNOLOGY

A DC compressor offers improved performance during periods of extended operation. It also features a split rotor with displaced electrical poles, enabling the suppression of electromagnetic noise. Low-speed performance characteristics have also been improved, leading to significant reductions in annual running costs.

STYLISH REMOTE CONTROLLERS

A fully-programmable 7-day timer offers the ability to switch all units on and off automatically to conserve power when rooms are unoccupied.

Units are able to accept external control inputs such as remote stop/start and fire alarm. System outputs including fault conditions, mode (heat/cool), and thermostat on are also available.

WALL CONTROLLERS



PC-ARF
Applicable to indoor models RPI-4.0, 5.0, 6.0 & 7.0

- 24/7 time schedule
- Eco mode
- Room temperature indication
- Sleep timer
- Power consumption display
- Backlight display



SPX-WKT
Applicable to indoor models RAD-E50, 60, 70

- 24/7 time schedule
- Eco mode
- Room temperature indication
- Sleep timer
- Power consumption display
- Backlight display

Already highly efficient, Hitachi Premium Inverter models offer **two additional ways** to configure systems to achieve even greater energy savings.

SELF-DEMAND CONTROL

Power consumption levels (as a percentage of the maximum) can be selected in advance. Following an external command during operation, the system will automatically detect the amount of power being used and limit itself to the predetermined amount during peak power usage periods.

WAVE MODE

When activated by an external command, this function cycles the system between full-power and a pre-selected reduced power setting every 10 to 20-minutes until the command is cancelled. Wave Mode results in lower average power usage and cost savings.

Applicable to RPI models

INTERNAL DRAIN PUMP

31cm Drain pump pressure lift.
RAD-E50, 60 and 70 only.



MODEL DIMENSIONS



RAD-E50 - 5kW
 RAD-E60 - 6kW
 RAD-E70 - 7kW

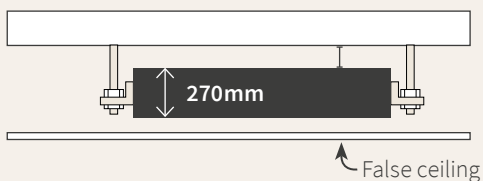

RPI 4.0 - 10kW
 RPI 5.0 - 12.5kW
 RPI 6.0 - 13kW

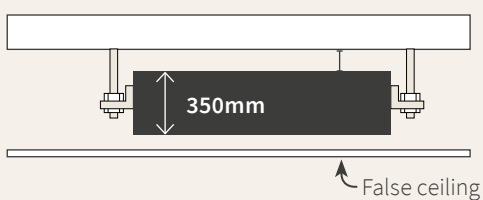

RPI 7.0 - 16kW

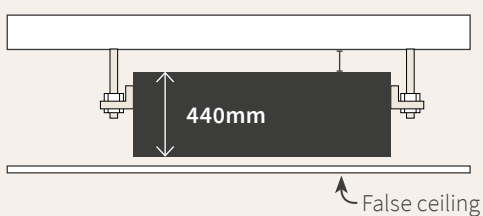

DUCTED SYSTEM

Can be combined with ducting grilles and accessories to provide superior filtration and effective clean air distribution.

KEY FEATURES

1. Space Saving Design

With a height of 270mm the RAD-E50, 60 and 70 can be installed in almost any application including homes, apartments or commercial buildings.

2. Easy Installation & Maintenance

Separable design unit for easier installation in limited roof space (RPI-4.0-6.0FSN2SQ).

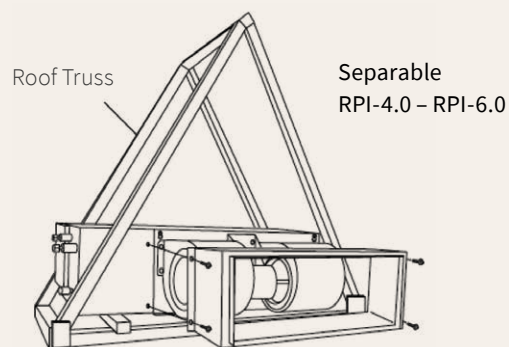

3. Quiet Operation

The well-balanced centrifugal fan provides quiet and efficient operation.



Zoning your spaces

PREMIUM ZONE CONTROL FEATURES

- Colour Touch Screen Controller
 - Can add additional touch pads
- Standard WiFi / 4G Access and Control suits:
 - IOS
 - Android
 - Windows
 - Smartphones and
 - Tablets
- Max 14 Zones available using WiFi Zone sensor
- Optional Wired iSense Zone Sensor Available
 - Has built in Motion Detector
 - Can close a zone off if motion is not detected
 - Can adjust zone temperature setting from the zone controller
- Individual temperature control for each Zone
 - Set airflow for each zone
- Personalise Zone names
- Set up Favourite Zones to suit your lifestyle
- Set up an Operating Schedule for Individual Zones to suit your lifestyle
- Maintains your personal settings in the event of a power failure
 - Memory via battery back up
- Auto Restart on resumption of power after a power failure.

Not applicable on RAD-E50, 60 & 70 models.

From single storey...

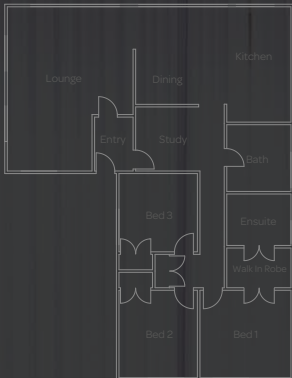

22.5°C

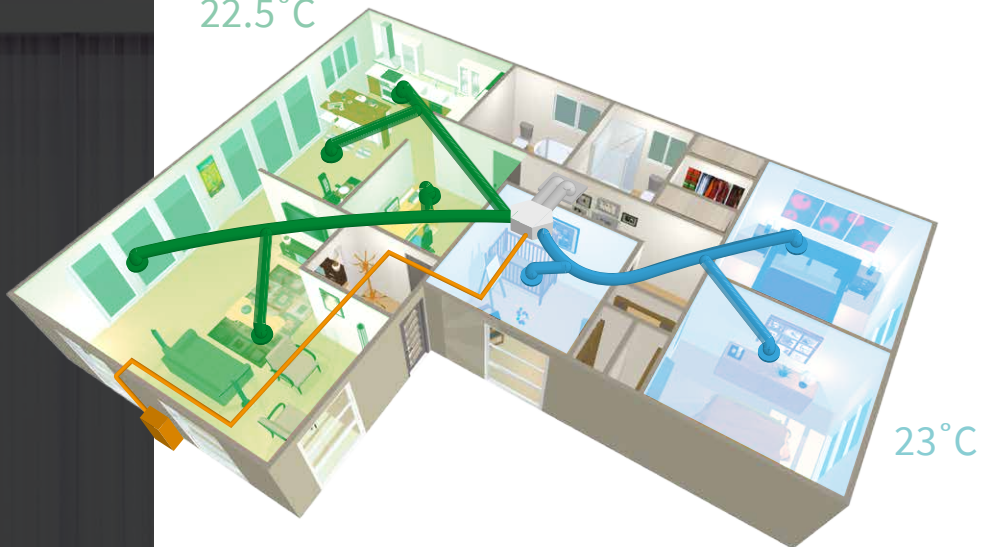

to multi storey homes, we've got your solution.



21.5°C

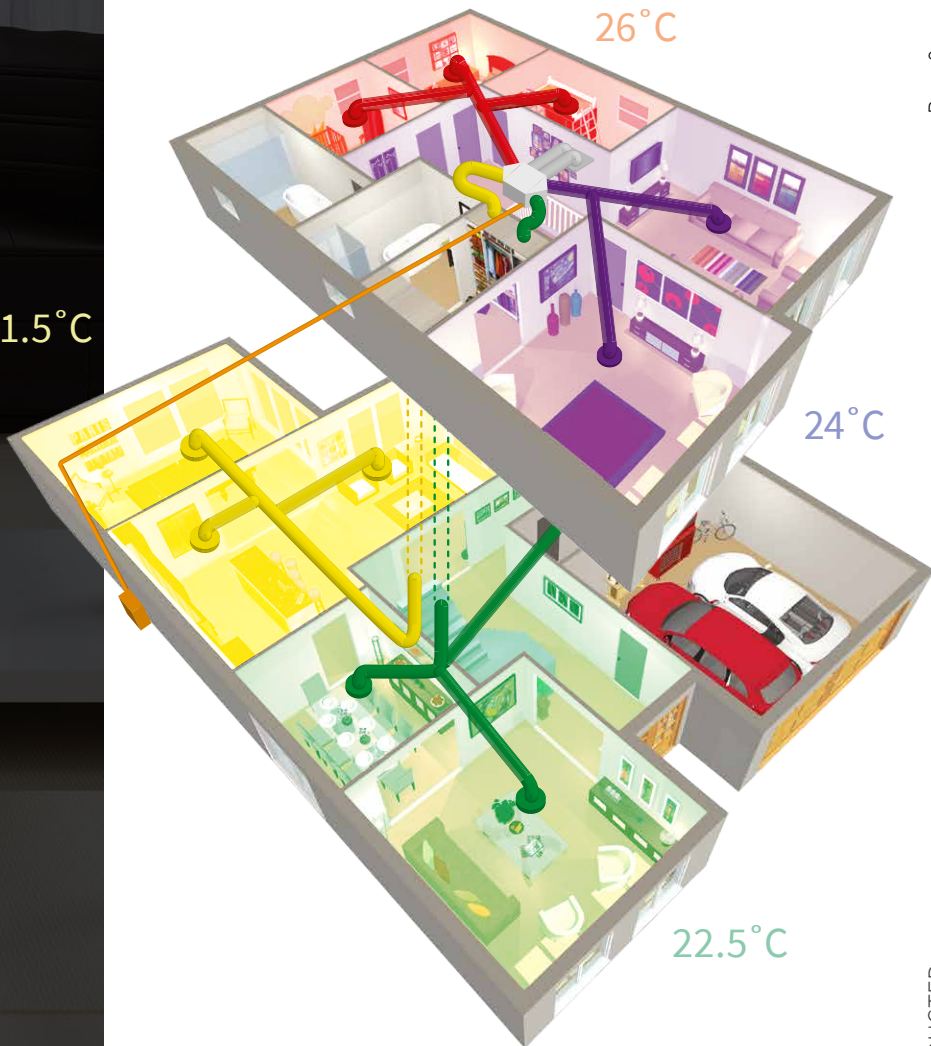



Premium zone control at the touch of a button

Intelligent design inside and beautiful design outside, Premium zone control offers you total temperature and airflow control of your ducted system at the touch of a button.

Premium Control Option

* Entire zone system not applicable on RAD-E50, 60, 70 models.



Optional WiFi app



Local room controller options*



The optional touch screen technology gives you total temperature control of your Hitachi ducted system. Easily adjust the air distribution, temperature or airflow to optimise your comfort.

You can design your control system just the way you like. From a layout consisting of WiFi sensors or wired controllers in each room linked to a centralised touch screen controller to touch screen controllers in each individual room - the choice is yours.

WiFi CONTROL APP

The WiFi and 4G enabled iZone App enables you to control your air conditioning system via your smart phone or tablet from anywhere. Now the whole family can come home to the perfect temperature.

WIRELESS SENSORS

Sleek temperature (zone) sensors that can operate the on/off feature for the zone.

SET AND FORGET - FAVOURITES

Create up to 9 'favourite' zone scenarios to suit your lifestyle, then schedule these 'favourites' to match everyday living. But for a quick set and forget 'system off' timer, just press the seven-setting sleep timer button and the Premium Zone Control takes care of the rest.

ISENSE HUMAN SENSOR

This clever optional zone controller detects if a room is unoccupied. iSense will then automatically adjust the room temperature or switch off the air conditioning to that room. iSense significantly improves energy efficiency and reduces the running cost of ducted air conditioning system's in homes and offices, directing the airflow only to the rooms you are using.

Optional Accessories



CARD KEY 'ON' AND 'OFF' FUNCTION

Switches the unit on or off via a remote device such as a hotel room card key. Save energy by switching the unit off when the room is unoccupied.



RUN AND ALARM SIGNAL

Signal indicates when a unit is running, or if the unit has stopped due to an internal fault. This is beneficial for projects where multiple units have been installed.



DEMAND RESPONSE MODULE (DRED)

Optional DRM module for instances where local requirements specify DRED compatibility.



Hi-KUMO



Convenient and intuitive, Hi-Kumo is a remote control interface allowing you to control your Hitachi air conditioner from anywhere.

Optional accessory*

With this application, you can:

- Simply and quickly pair all your compatible Hitachi units
- Create in seconds a weekly schedule to minimise your energy consumption
- Ensure optimal comfort in your home by checking the temperature at a glance
- Change modes and temperature
- Change airflow remotely
- Benefit from a comfortable environment on your return from holiday by activating 'Holiday Mode'
- Remotely control if the unit is on or off.

*Applicable to RAD-E50YHA, RAD-E60YHA, RAD-E70YHA models only.



Features and options comparison table

	RAD-E50 – 70 RAC-E50 – 70	RPI 4.0 – 7.0 RAS-HVNC 4.0 – 7.0
	5, 6, 7kW	10, 12.5, 13, 16kW
Eco mode function	●	●
Sleep mode	●	●
Room temperature display	●	●
Ultra low standby power	●	●
Auto restart function if set on outdoor unit	●	●
Anti corrosion paint - outdoor unit	●	●
12hr timer control	●	●
24/7 time clock function	●	●
Power consumption display	●	●
PC-ARF wired controller	–	●
4 speed indoor fan	●	–
SPX-WKT wired controller	●	■
Remote key card input	■	■
DRED Demand response module	■	■
Run and Alarm signal	■	■
Hi-Kumo WiFi control	■	–
Premium Zone control (with WiFi)	–	■

- STANDARD
- OPTIONAL
- NOT AVAILABLE



—
Technical specifications

Ducted - Technical Data

MODEL

Indoor	RAD-E50YHA	RAD-E60YHA	RAD-E70YHA
Outdoor	RAC-E50YHA	RAC-E60YHA	RAC-E70YHA
Capacity (kW)			
Cooling Capacity	5.0	6.0	7.0
Cooling Capacity Range	1.2 - 5.8	1.2 - 6.5	1.5 - 8.0
Heating Capacity	6.0	7.0	8.0
Heating Capacity Range	1.2 - 6.8	1.2 - 8.0	1.5 - 8.5
Energy Efficiency			
EER / AEER	3.82 / 3.80	3.54 / 3.52	3.34 / 3.32
COP / ACOP	3.90 / 3.87	3.71 / 3.69	3.40 / 3.39
Air Flow			
Air Flow l/s (Hi / Med / Low / S low)	300 / 250 / 200 / 170	300 / 250 / 200 / 170	415 / 325 / 200 / 170
External Static Pa	50 ~ 160	50 ~ 160	50 ~ 160
Dimensions			
Indoor Unit: (H x W x D mm)	270 x 900 x 720	270 x 900 x 720	270 x 900 x 720
Outdoor: (H x W x D mm)	750 x 850 x 298	750 x 850 x 298	800 x 850 x 298
Indoor Unit Separable	No	No	No
Weights: Indoor kg / Outdoor kg	35 / 50	35 / 50	35 / 52
Sound Pressure Level (dB(a))			
Indoor Unit (Hi / Med / Low / S low) cooling	39 / 35 / 32 / 29	39 / 35 / 32 / 29	39 / 35 / 32 / 29
Outdoor Unit (Cool / Heat / Night)	50 / 53	50 / 53	50 / 53
Working Range (°C db)			
Cooling	-15° / 46°C		
Heating	-15° / 24°C		
Piping			
Pipe Connection Sizes Liquid Ømm / Gas Ømm	6.35 / 12.70 (1/4" / 1/2")	6.35 / 12.70 (1/4" / 1/2")	6.35 / 15.88 (1/4" / 5/8")
Max Pipe Length (m)	30	30	30
Max Pre Charged Length (m)	30	30	30
Max Pipe Lift (m) (Outdoor Above / Outdoor Below)	20		
Refrigeration Connections (Indoor / Outdoor)	Flare Nut / Flare Nut		
Air Spigot / Drain Dimensions			
Supply Air Spigot (W x H mm)	815 x 219	815 x 219	815 x 219
Return Air Spigot (W x H mm)	805 x 220	805 x 220	805 x 220
Drain dimensions	Ø32	Ø32	Ø32
Electrical			
Power Supply	AC 1 Ph 220 - 240V 50Hz		
Outdoor Unit Max Current	12	14	16
Recommend fuse size	20A	20A	20A
Interconnection Wires mains	3pcs + Earth 1.5mm ²		
Interconnection Wires comms	Refer installation manual		
Refrigerant			
	R32		

NOTES:

The nominal cooling and heating capacity is the combined capacity of the Hitachi standard split system, and is based on the JIS standard B8616. Cooling Operation Conditions: Indoor Air Inlet Temperature: 27°C DB, 19.0°C WB; Outdoor Air Inlet Temperature: 35°C DB. Heating Operation Conditions: Indoor Air Inlet Temperature: 20°C DB; Outdoor Air Inlet Temperature:

RPI-4.0FSN2SQ RAS-4HVNC1	RPI-5.0FSN2SQ RAS-5HVNC1	RPI-6.0FSN2SQ RAS-6HVNC1	RPI-7.0FSN2SQ RAS-7HVRNM2
10.0	12.5	13.0	16.0
4.5 - 11.2	5.7 - 14.0	6.0 - 16.0	6.0 - 18.0
11.2	14.0	16.0	18.0
5.0 - 14.0	5.0 - 18.0	5.0 - 20.0	5.0 - 20.0
3.63 / 3.46	3.18 / 3.01	3.11 / 2.96	3.52 / 3.35
4.26 / 4.02	4.05 / 3.78	3.90 / 3.68	3.91 / 3.71
600 / 550 / 416 / - 150 (max)	783 / 716 / 566 / - 150 (max)	933 / 833 / 666 / - 135 (max)	1083 / 950 / 766 / - 150 (max)
350 x 1076 x 800 1140 x 950 x 370 Yes 57 / 79	350 x 1300 x 800 1140 x 950 x 370 Yes 61 / 89	350 x 1300 x 800 1140 x 950 x 370 Yes 63 / 89	440 x 1430 x 550 1380 x 950 x 370 No 75 / 104
48 / 45 / 41 / - 52 / 54 / 50	49 / 46 / 43 / - 52 / 54 / 50	53 / 49 / 45 / - 55 / 57 / 53	51 / 47 / 42 / - 49 / 53 / 46
<p>..... -5°/46°C</p> <p>..... -20°/24°C</p>			
9.52 / 15.88 (3/8" / 5/8") 70 30	9.52 / 15.88 (3/8" / 5/8") 75 30	9.52 / 15.88 (3/8" / 5/8") 75 30	9.52 / 15.88 (3/8" / 5/8") 75 30
<p>..... 30 / 20</p> <p>..... Flare Nut / Flare Nut</p>			
980 x 220 813 x 306 Ø25	1205 x 220 813 x 306 Ø25	1205 x 220 935 x 306 Ø25	830 x 300 1288 x 402 Ø25
<p>..... AC 1 Ph 220 - 240V 50Hz</p>			
26 -	26 -	26 -	32 -
<p>..... 0.75mm² 2C + E (min)</p> <p>..... Twisted Pair Cable with Shield - 0.75mm² min</p>			
<p>..... R410A</p>			

7°C DB, 6°C WB. Published capacities based on Piping Length: 7.5 metres. The sound pressure level is based on following conditions: 1.5 metres beneath the unit with discharge duct (2.0m) and return duct (1.0m). Outdoor Units: 1 metre from the unit service cover surface, and 1.5 metres from floor level. Voltage of the power source for the indoor fan motor is 220V. In case of the power

source of 240V, the sound pressure level increases by about 1 or 2dB. The above data was measured in an anechoic chamber so that reflected sound should be taken into consideration in the field.

temperzone Australia Pty Ltd

ENQUIRIES

sales@temperzone.com.au

AUSTRALIA

Sydney: (02) 8822 5700
Melbourne: (03) 8769 7600
Brisbane: (07) 3308 8333
Adelaide: (08) 8115 2111

DISTRIBUTORS

Newcastle: (02) 4962 1155
Perth: (08) 6399 5900
Launceston: (03) 6331 4209

NEW ZEALAND

Auckland: (09) 279 5250
Wellington: (04) 569 3262
Christchurch: (03) 379 3216

HITACHI. CERTIFIED QUALITY



5 YEAR WARRANTY ON PARTS AND LABOUR*



WARRANTY

hitachiaircon.com.au
hitachiheatpump.co.nz



The specifications of this catalogue may change without prior notice to allow Hitachi Cooling & Heating to incorporate the latest innovations for its customers. The information contained in this catalogue is merely informative. Hitachi Cooling & Heating declines any responsibility in the broadest sense, for damage, direct or indirect, arising from the use and / or interpretation of the recommendations in this catalogue.

Find Hitachi Cooling & Heating products with the best service and conditions at your Hitachi Distributor.

* Refer to Australia Hitachi Warranty for fully conditions.