



PRODUCT CATALOG

Rugged. Versatile. Custom Designed.

STANLEY.

VIDMAR

For more than 40 years, Vidmar has meant one thing to customers around the world—heavy-duty storage solutions for heavy-duty applications.

Swiss manufacturer A&R Weidemar introduced the first modular-drawer cabinet in the 1940s in the form of a tool crib composed of enclosed steel storage modules that held full-suspension heavy-duty drawers. When introduced to these tool cribs, John Kleinoder, a Brooklyn-based tool and die maker, saw them as the perfect solution for storing metal working tools. He also saw that they were much more than toolboxes, and knew that their potential market went well beyond machine shops.

In 1958, Kleinoder arranged to manufacture Weidemar cabinets in the United States under the name “Vidmar.” In 1962, Vidmar cabinets became part of the first photocopiers made by Haloid Corporation, which would become Xerox Corporation. In 1965, Xerox asked Vidmar to open a plant in Allentown, Pennsylvania. A year later, Kleinoder sold the company to The Stanley Works, now known as Stanley Black & Decker of New Britain, Connecticut.

Today, Vidmar, as the company is now known, still makes all of our products to order at our Allentown facility. In the years that have passed since our inception in 1966, Vidmar has watched the demand for efficient, durable storage continue to grow and grow as businesses and industries become more space-, cost-, and productivity-conscious. Vidmar is a common name in countless fields, including military, automotive, manufacturing, healthcare, heavy equipment, agricultural, power generation/utilities, government (GSA Contract #GS-27F-5062C), and many more.

Whether it's preconfigured or custom-configured storage cabinets, workstations and technical benching, mobile cabinets and toolboxes, mezzanines, vertical automated storage and retrieval systems, adjustable racking systems, or seating, professionals worldwide depend on Vidmar for productivity improvements that directly contribute to a healthier bottom line. Couple this with a knowledgeable, highly trained team of Territory Sales Managers that can guide, train, and make recommendations on all aspects of the Vidmar product offering—including onsite, no-obligation surveys—and you have a turnkey solution that dramatically reduces the time required between initial concept and final implementation. Superior products, innovative solutions, and an unmatched knowledge base all combine to deliver the type of ROI that's critical to staying competitive in today's market. This winning combination has positioned the Vidmar brand as the market leader it is today.

About Vidmar: A division of Stanley Black & Decker, Vidmar offers storage solutions to all industries, with modular space-saving systems that provide quick, safe access to parts, tools, and supplies. A Vidmar system can maximize valuable floor space while providing an integrated solution for inventory control. Customers can arrange a free analysis of their storage needs by calling 800-523-9462. Detailed information on Vidmar products is available at STANLEYVidmar.com



VIDMAR: Table of Contents



VIDMAR

| | |
|-----------------------|----------|
| Introduction | opposite |
| Table of Contents | page 1 |
| Value Proposition | page 2 |
| Industry Applications | page 4 |

CABINETS

| | |
|----------------------------------|---------|
| Preconfigured Cabinets | page 6 |
| How to Configure | page 28 |
| Housing Features & Accessories | page 30 |
| Drawer Features & Accessories | page 32 |
| Roll-Out Shelf/Roll-Out Tray | page 38 |
| Shelf/Shelf Door Cabinets | page 40 |
| Overhead Cabinets | page 42 |
| Mobile Cabinets | page 44 |
| Workcenters/Toolboxes | page 48 |
| Pass-Through & Computer Cabinets | page 52 |
| Safety Cabinets | page 53 |
| Mezzanine | page 54 |

SPECIALTY STORAGE

| | |
|-----------------------------------|---------|
| Weapons Storage | page 56 |
| Rapid Deployment Container Insert | page 58 |
| Lockers | page 59 |
| StaticGard/ESD | page 60 |
| 6S | page 64 |
| NC Tool Storage | page 66 |
| Desks | page 70 |

WORKSTATIONS & BENCHING

| | |
|---|---------|
| Preconfigured | page 72 |
| Bench Legs | page 76 |
| Stringers, Footrests & Footrest Shelves | page 77 |
| Modesty Panels & Stops | page 78 |
| Outlets & Lights | page 79 |
| Risers & Back Panels | page 80 |
| Work Surfaces | page 82 |
| Overhead Benching Cabinets/Bookcases | page 84 |
| Under-Bench Cabinets | page 85 |
| Technical Bench Cabinets | page 86 |
| Nexus | page 90 |

CHAIRS

page 106

VERTICAL STORAGE SOLUTIONS

| | |
|--------------------|----------|
| Adjustable Racking | page 108 |
| STAK System® | page 110 |
| Tower | page 114 |
| Carousels | page 116 |

PAINT FINISHES

page 120

QUICKSHIP

page 121

ACCESSORIES/SPARE PARTS

page 122

SO YOU'VE HEARD THAT VIDMAR OFFERS SOME OF THE WORLD'S TOUGHEST STORAGE SOLUTIONS. BUT BEYOND UNSURPASSED RUGGEDNESS, WHAT ARE THE "BIG BENEFITS" OF CHOOSING VIDMAR? FROM EXTREME SPACE SAVINGS TO INCREASED PRODUCTIVITY, VIDMAR IS THE ULTIMATE USE OF YOUR STORAGE SPACE.

Problem

Have your storage needs outgrown your existing footprint? Are you restricted by limited floor space? Is your inventory unorganized? Does it take you too long to find necessary parts? Do you need to lock and secure valuable equipment? If any of these scenarios sound familiar, Vidmar has your solution.

Solution

Vidmar improves every aspect of your workspace with integrated storage systems engineered specifically for your needs. Ergonomic workstations increase employee safety. Adjustable pallet racking can be managed by one operator in as little as two minutes for inventory of various size and shape. And just two high-density drawer cabinets with custom-configured compartments store the same amount of material as five open shelving units. Simply put, Vidmar makes the most of your storage space.

Benefits

Inventory is given specific, identifiable locations, all within easy reach and full view, meaning fast, efficient retrieval. This allows resources to be redeployed to other areas within the facility for greater productivity and throughput.

Enclosed cabinet storage safeguards against dust, dirt, damage, and loss with locked and secure drawers—your sensitive inventory is never compromised.

And as your storage requirements evolve, Vidmar is right there with you providing flexible modular storage solutions that can be infinitely expanded as your needs change.

"All of the parts are in one place, and the high-dollar electronics are securely locked. Everything is easier to locate and the adjustability of the drawers is priceless. This was one of the smartest investments we could have ever made in the department," says Dallas Volvo Truck Center parts manager Mitch Leone.



Vidmar "Big Benefits"



Value Proposition

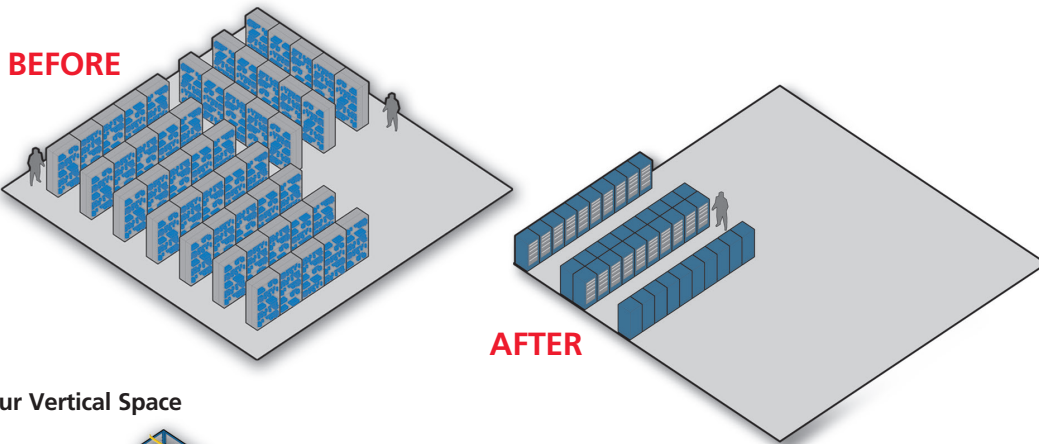

Leverage Your Vertical Space

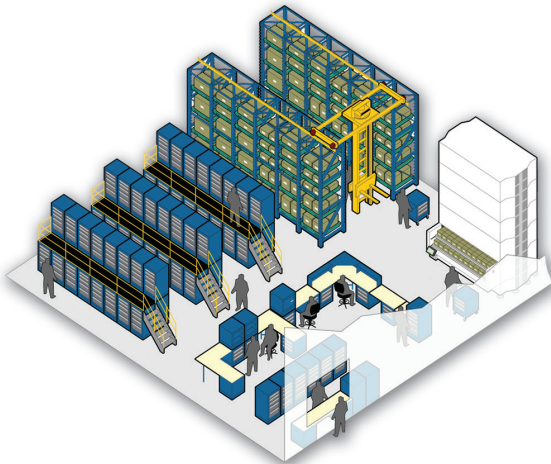

BEFORE



AFTER





Manufacturing



Manufacturing

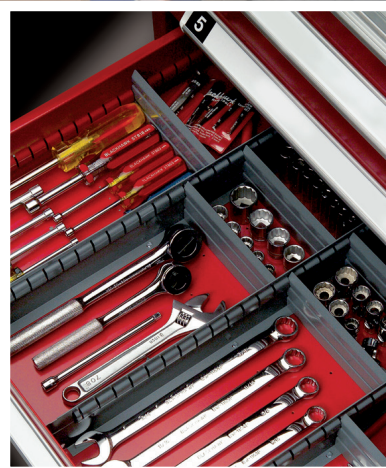

Manufacturing



Manufacturing

Industry Applications



Automotive



Automotive

Government



Government



Agriculture



Agriculture

CABINETS: Preconfigured Cabinets

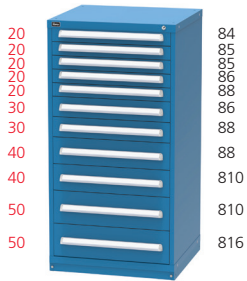

84
85
85
86
88
88
86
88
88
810
810
816

RP3092AL

11 Drawers
200 Compartments
Usable Drawer Heights
2-1/4 in. (57 mm)
3-7/8 in. (98 mm)
5-3/8 in. (137 mm)
7 in. (178 mm)

594 lbs. (269 kg.) Shipping Weight

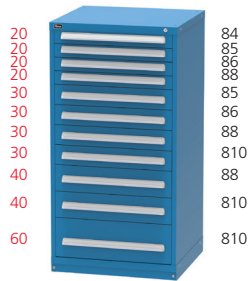

84
85
86
88
85
86
88
810
88
810
810

RP3098AL

11 Drawers
204 Compartments
Usable Drawer Heights
2-1/4 in. (57 mm)
3 in. (76 mm)
5-3/8 in. (137 mm)
8-1/2 in. (216 mm)

591 lbs. (268 kg.) Shipping Weight

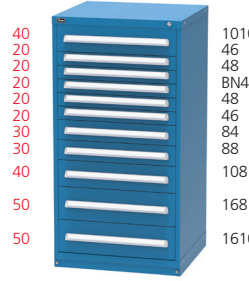

1010
46
48
BN48
48
46
84
88
108
168
1610

RP3404AL

11 Drawers
275 Compartments
Usable Drawer Heights
2-1/4 in. (57 mm)
3-7/8 in. (98 mm)
5-3/8 in. (137 mm)
7 in. (178 mm)

569 lbs. (258 kg.) Shipping Weight

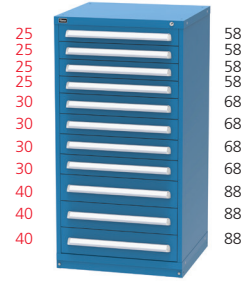

58
58
58
58
68
68
68
68
88
88

SCU3079AL

11 Drawers
224 Compartments
Usable Drawer Heights
3 in. (76 mm)
3-7/8 in. (98 mm)
5-3/8 in. (137 mm)

562 lbs. (255 kg.) Shipping Weight

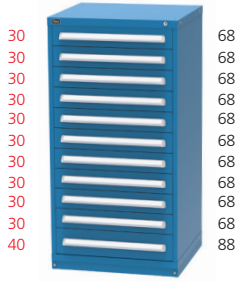

68
68
68
68
68
68
68
68
68
68
68
68

SCU3067AL

11 Drawers
216 Compartments
Usable Drawer Heights
3-7/8 in. (98 mm)
5-3/8 in. (137 mm)

565 lbs. (256 kg.) Shipping Weight

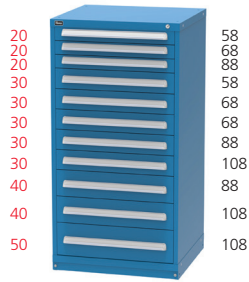

58
68
88
58
68
68
88
108
88
108
108

SEP3306AL

11 Drawers
192 Compartments
Usable Drawer Heights
2-1/4 in. (57 mm)
3-7/8 in. (98 mm)
5-3/8 in. (137 mm)
7 in. (178 mm)

596 lbs. (270 kg.) Shipping Weight



58
58
58
68
68
68
68
68
88
88
88

SCU3306AL

11 Drawers
216 Compartments
Usable Drawer Heights
2-1/4 in. (57 mm)
3-7/8 in. (98 mm)
5-3/8 in. (137 mm)
7 in. (178 mm)

592 lbs. (269 kg.) Shipping Weight

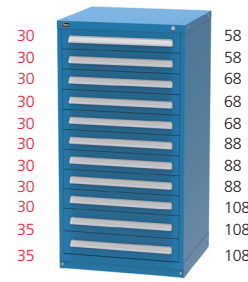

58
58
68
68
68
88
88
88
108
108
108

SEP3062AL

11 Drawers
192 Compartments
Usable Drawer Heights
3-7/8 in. (98 mm)
4-5/8 in. (117 mm)

594 lbs. (269 kg.) Shipping Weight



68
68
68
68
68
68
68
68
68
68
68
68

SCU3062AL

11 Drawers
220 Compartments
Usable Drawer Heights
3-7/8 in. (98 mm)
4-5/8 in. (117 mm)

593 lbs. (269 kg.) Shipping Weight

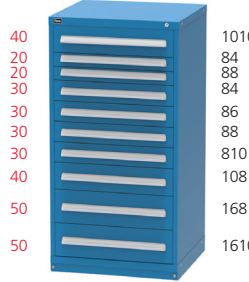

1010
84
88
84
86
88
810
108
168
1610

RP3406AL

10 Drawers
163 Compartments
Usable Drawer Heights
3-7/8 in. (98 mm)
2-1/4 in. (57 mm)
7 in. (178 mm)
5-3/8 in. (137 mm)

558 lbs. (253 kg.) Shipping Weight

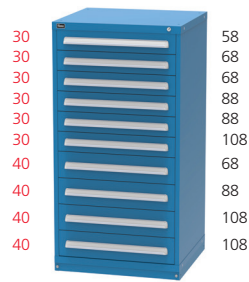

58
68
68
88
88
108
68
88
108
108

SEP3110AL

10 Drawers
164 Compartments
Usable Drawer Heights
3-7/8 in. (98 mm)
5-3/8 in. (137 mm)

569 lbs. (258 kg.) Shipping Weight

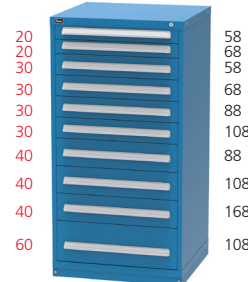

58
68
58
68
88
108
88
108
168
108

SEP3126AL

10 Drawers
164 Compartments
Usable Drawer Heights
2-1/4 in. (57 mm)
3-7/8 in. (98 mm)
5-3/8 in. (137 mm)
8-1/2 in. (216 mm)

565 lbs. (256 kg.) Shipping Weight



SCU3110AL
 10 Drawers
 184 Compartments
 Usable Drawer Heights
 3-7/8 in. (98 mm)
 5-3/8 in. (137 mm)
 567 lbs. (257 kg.) Shipping Weight



SCU3108AL
 10 Drawers
 192 Compartments
 Usable Drawer Heights
 3-7/8 in. (98 mm)
 4-5/8 in. (117 mm)
 5-3/8 in. (137 mm)
 535 lbs. (243 kg.) Shipping Weight

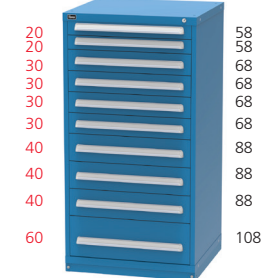

SCU3126AL
 10 Drawers
 188 Compartments
 Usable Drawer Heights
 2-1/4 in. (57 mm)
 3-7/8 in. (98 mm)
 5-3/8 in. (137 mm)
 8-1/2 in. (216 mm)
 563 lbs. (255 kg.) Shipping Weight

EYE LEVEL HEIGHT CONTINUED

Model 340
 59 in. (1499 mm) high
 30 in. (762 mm) wide
 27-3/4 in. (705 mm) deep

To order cabinets without locks, delete the "L" suffix from the model number (example: SEP3014AL becomes SEP3014A).

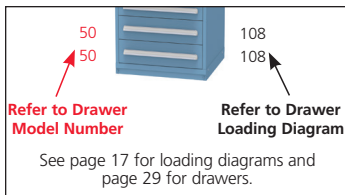

SEP3140AL
 9 Drawers
 144 Compartments
 Usable Drawer Heights
 3-7/8 in. (98 mm)
 4-5/8 in. (117 mm)
 5-3/8 in. (137 mm)
 6-1/4 in. (159 mm)
 536 lbs. (243 kg.) Shipping Weight



SEP3144AL
 9 Drawers
 140 Compartments
 Usable Drawer Heights
 3-7/8 in. (98 mm)
 5-3/8 in. (137 mm)
 8-1/2 in. (216 mm)
 538 lbs. (244 kg.) Shipping Weight



SCU3144AL
 9 Drawers
 156 Compartments
 Usable Drawer Heights
 3-7/8 in. (98 mm)
 5-3/8 in. (137 mm)
 8-1/2 in. (216 mm)
 536 lbs. (243 kg.) Shipping Weight

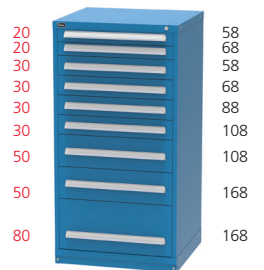

SEP3155AL
 9 Drawers
 144 Compartments
 Usable Drawer Heights
 2-1/4 in. (57 mm)
 3-7/8 in. (98 mm)
 7 in. (178 mm)
 11-3/4 in. (292 mm)
 529 lbs. (240 kg.) Shipping Weight



SCU3352AL
 9 Drawers
 152 Compartments
 Usable Drawer Heights
 3-7/8 in. (98 mm)
 5-3/8 in. (137 mm)
 7 in. (178 mm)
 529 lbs. (240 kg.) Shipping Weight

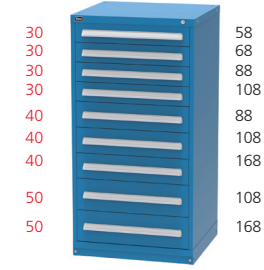

SEP3352AL
 9 Drawers
 128 Compartments
 Usable Drawer Heights
 3-7/8 in. (98 mm)
 5-3/8 in. (137 mm)
 7 in. (178 mm)
 529 lbs. (240 kg.) Shipping Weight

CABINETS: Preconfigured Cabinets

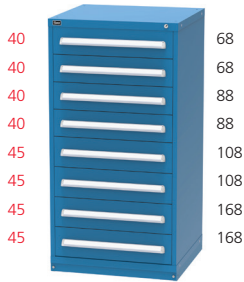

SEP3157AL
8 Drawers
112 Compartments
Usable Drawer Heights
5-3/8 in. (137 mm)
6-1/4 in. (159 mm)
508 lbs. (230 kg.) Shipping Weight

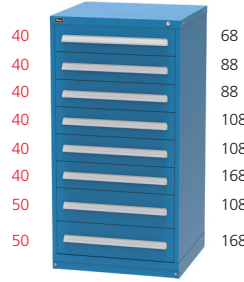

SEP3163AL
8 Drawers
104 Compartments
Usable Drawer Heights
5-3/8 in. (137 mm)
7 in. (178 mm)
508 lbs. (230 kg.) Shipping Weight

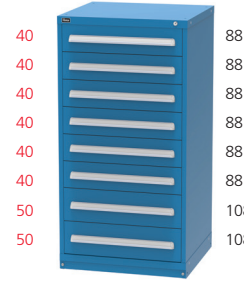

SCU3163AL
8 Drawers
120 Compartments
Usable Drawer Heights
5-3/8 in. (137 mm)
7 in. (178 mm)
504 lbs. (229 kg.) Shipping Weight

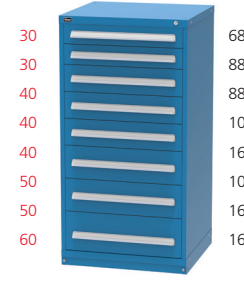

SEP3371AL
8 Drawers
100 Compartments
Usable Drawer Heights
3-7/8 in. (98 mm)
5-3/8 in. (137 mm)
7 in. (178 mm)
8-1/2 in. (216 mm)
480 lbs. (218 kg.) Shipping Weight



SEP3189AL
7 Drawers
80 Compartments
Usable Drawer Heights
5-3/8 in. (137 mm)
7 in. (178 mm)
472 lbs. (214 kg.) Shipping Weight



SCU3189AL
7 Drawers
88 Compartments
Usable Drawer Heights
5-3/8 in. (137 mm)
7 in. (178 mm)
470 lbs. (213 kg.) Shipping Weight



SCU3389AL
7 Drawers
96 Compartments
Usable Drawer Heights
5-3/8 in. (137 mm)
7 in. (178 mm)
8-1/2 in. (216 mm)
463 lbs. (210 kg.) Shipping Weight



SEP3203AL
6 Drawers
64 Compartments
Usable Drawer Heights
6-1/4 in. (159 mm)
7 in. (178 mm)
8-1/2 in. (216 mm)
11-3/4 in. (292 mm)
436 lbs. (198 kg.) Shipping Weight



SCU3398AL
6 Drawers
72 Compartments
Usable Drawer Heights
7 in. (178 mm)
8-1/2 in. (216 mm)
11-3/4 in. (292 mm)
432 lbs. (196 kg.) Shipping Weight



SCU3399AL
5 Drawers
52 Compartments
Usable Drawer Heights
5-3/8 in. (137 mm)
8-1/2 in. (216 mm)
10-1/8 in. (257 mm)
11-3/4 in. (292 mm)
13-1/4 in. (337 mm)
399 lbs. (181 kg.) Shipping Weight



SEP3214AL
5 Drawers
37 Compartments
Usable Drawer Heights
7 in. (178 mm)
8-1/2 in. (216 mm)
10-1/8 in. (257 mm)
13-1/4 in. (337 mm)
392 lbs. (178 kg.) Shipping Weight



SEP3219AL
4 Drawers
29 Compartments
Usable Drawer Heights
11-3/4 in. (292 mm)
13-1/4 in. (337 mm)
13-1/4 in. (337 mm)
357 lbs. (162 kg.) Shipping Weight

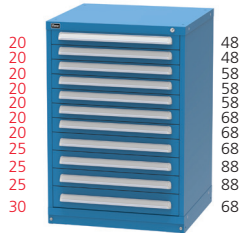

SEP2004AL
 11 Drawers
 248 Compartments
 Usable Drawer Heights
 2-1/4 in. (57 mm)
 3 in. (76 mm)
 3-7/8 in. (98 mm)
 547 lbs. (248 kg.) Shipping Weight

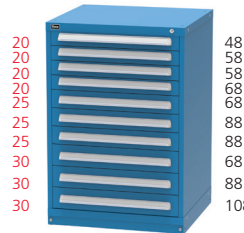

SEP2012AL
 10 Drawers
 200 Compartments
 Usable Drawer Heights
 2-1/4 in. (57 mm)
 3 in. (76 mm)
 3-7/8 in. (98 mm)
 513 lbs. (233 kg.) Shipping Weight

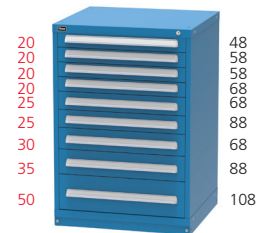

SEP2025AL
 9 Drawers
 184 Compartments
 Usable Drawer Heights
 2-1/4 in. (57 mm)
 3 in. (76 mm)
 3-7/8 in. (98 mm)
 4-5/8 in. (117 mm)
 7 in. (178 mm)
 485 lbs. (220 kg.) Shipping Weight

COUNTER HEIGHT

Model 245

44 in. (1118 mm) high
 30 in. (762 mm) wide
 27-3/4 in. (705 mm) deep

To order cabinets without locks, delete the "L" suffix from the model number (example: SEP3014AL becomes SEP3014A).

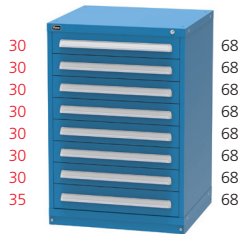

SCU2029AL
 8 Drawers
 160 Compartments
 Usable Drawer Heights
 3-7/8 in. (98 mm)
 4-5/8 in. (117 mm)
 455 lbs. (206 kg.) Shipping Weight



SEP2029AL
 8 Drawers
 144 Compartments
 Usable Drawer Heights
 3-7/8 in. (98 mm)
 4-5/8 in. (117 mm)
 457 lbs. (207 kg.) Shipping Weight

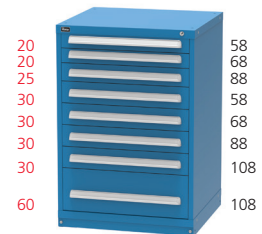

SEP2037AL
 8 Drawers
 144 Compartments
 Usable Drawer Heights
 2-1/4 in. (57 mm)
 3 in. (76 mm)
 3-7/8 in. (98 mm)
 8-1/2 in. (216 mm)
 456 lbs. (207 kg.) Shipping Weight

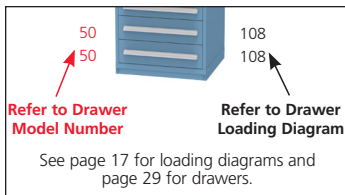

SCU2041AL
 7 Drawers
 140 Compartments
 Usable Drawer Height
 4-5/8 in. (117 mm)
 415 lbs. (188 kg.) Shipping Weight



SEP2041AL
 7 Drawers
 120 Compartments
 Usable Drawer Height
 4-5/8 in. (117 mm)
 417 lbs. (189 kg.) Shipping Weight

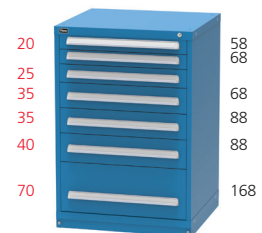

SEP2058AL
 7 Drawers
 120 Compartments
 Usable Drawer Heights
 2-1/4 in. (57 mm)
 3 in. (76 mm)
 4-5/8 in. (117 mm)
 5-3/8 in. (137 mm)
 10-1/8 in. (257 mm)
 420 lbs. (191 kg.) Shipping Weight

CABINETS: Preconfigured Cabinets



SCU2043AL
7 Drawers
128 Compartments
Usable Drawer Heights
3-7/8 in.(98 mm)
4-5/8 in. (117 mm)
5-3/8 in. (137 mm)
425 lbs. (193 kg.) Shipping Weight

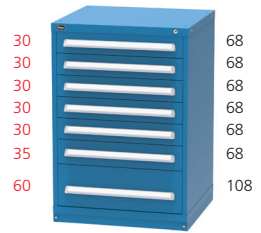

SCU2089AL
7 Drawers
132 Compartments
Usable Drawer Heights
3-7/8 in.(98 mm)
4-5/8 in. (117 mm)
8-1/2 in. (216 mm)
408 lbs. (185 kg.) Shipping Weight

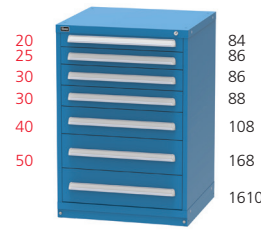

RP2102AL
7 Drawers
114 Compartments
Usable Drawer Heights
2-1/4 in. (57 mm)
3 in. (76 mm)
3-7/8 in.(98 mm)
5-3/8 in. (137 mm)
7 in. (178 mm)
419 lbs. (190 kg.) Shipping Weight

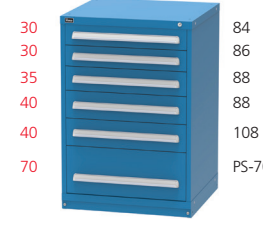

RP2112AL
6 Drawers
98 Compartments
Usable Drawer Heights
3-7/8 in.(98 mm)
4-5/8 in. (117 mm)
5-3/8 in. (137 mm)
10-1/8 in. (257 mm)
397 lbs. (180 kg.) Shipping Weight

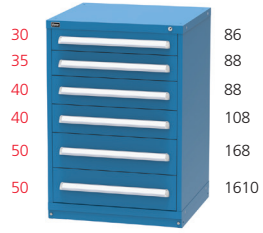

RP2113AL
6 Drawers
78 Compartments
Usable Drawer Heights
3-7/8 in.(98 mm)
4-5/8 in. (117 mm)
5-3/8 in. (137 mm)
7 in. (178 mm)
390 lbs. (177 kg.) Shipping Weight

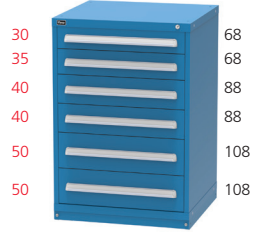

SCU2066AL
6 Drawers
96 Compartments
Usable Drawer Heights
3-7/8 in.(98 mm)
4-5/8 in. (117 mm)
5-3/8 in. (137 mm)
7 in. (178 mm)
392 lbs. (178 kg.) Shipping Weight

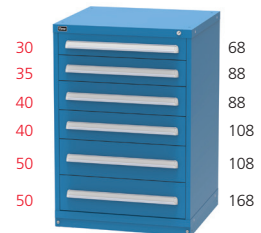

SEP2066AL
6 Drawers
84 Compartments
Usable Drawer Heights
3-7/8 in.(98 mm)
4-5/8 in. (117 mm)
5-3/8 in. (137 mm)
7 in. (178 mm)
395 lbs. (179 kg.) Shipping Weight



SCU2070AL
5 Drawers
76 Compartments
Usable Drawer Heights
6-1/4 in. (159 mm)
7 in. (178 mm)
360 lbs. (163 kg.) Shipping Weight



SCU2076AL
4 Drawers
48 Compartments
Usable Drawer Heights
6-1/4 in. (159 mm)
7 in. (178 mm)
8-1/2 in. (216 mm)
13-1/4 in. (337 mm)
326 lbs. (148 kg.) Shipping Weight



SEP2076AL
4 Drawers
44 Compartments
Usable Drawer Heights
6-1/4 in. (159 mm)
7 in. (178 mm)
8-1/2 in. (216 mm)
13-1/4 in. (337 mm)
330 lbs. (150 kg.) Shipping Weight



SCU2079AL
3 Drawers
27 Compartments
Usable Drawer Heights
10-7/8 in. (276 mm)
11-3/4 in. 9318 mm)
13-1/4 in. (337 mm)
282 lbs. (128 kg.) Shipping Weight



SEP2079AL
3 Drawers
17 Compartments
Usable Drawer Heights
10-7/8 in. (276 mm)
11-3/4 in. (337 mm)
13-1/4 in. (337 mm)
285 lbs. (129 kg.) Shipping Weight

CABINETS



SCU1904AL
 8 Drawers
 176 Compartments
 Usable Drawer Heights
 2-1/4 in. (57 mm)
 3-7/8 in. (98 mm)
 5-3/8 in. (137 mm)
 440 lbs. (200 kg.) Shipping Weight

SCU1905AL
 7 Drawers
 144 Compartments
 Usable Drawer Heights
 2-1/4 in. (57 mm)
 3-7/8 in. (98 mm)
 5-3/8 in. (137 mm)
 7 in. (178 mm)
 387 lbs. (176 kg.) Shipping Weight

SEP1905AL
 7 Drawers
 140 Compartments
 Usable Drawer Heights
 2-1/4 in. (57 mm)
 3-7/8 in. (98 mm)
 5-3/8 in. (137 mm)
 7 in. (178 mm)
 387 lbs. (176 kg.) Shipping Weight

STAND-UP HEIGHT

Model 200

37 in. (940 mm) high
 30 in. (762 mm) wide
 27-3/4 in. (705 mm) deep

To order cabinets without locks, delete the "L" suffix from the model number (example: SEP3014AL becomes SEP3014A).

SCU1910AL
 6 Drawers
 144 Compartments
 Usable Drawer Heights
 3-7/8 in. (98 mm)
 5-3/8 in. (137 mm)
 379 lbs. (172 kg.) Shipping Weight

SCU1915AL
 5 Drawers
 80 Compartments
 Usable Drawer Height
 5-3/8 in. (137 mm)
 339 lbs. (154 kg.) Shipping Weight

SCU1917AL
 5 Drawers
 84 Compartments
 Usable Drawer Heights
 2-1/4 in. (57 mm)
 3-7/8 in. (98 mm)
 5-3/8 in. (137 mm)
 7 in. (178 mm)
 8-1/2 in. (216 mm)
 335 lbs. (152 kg.) Shipping Weight

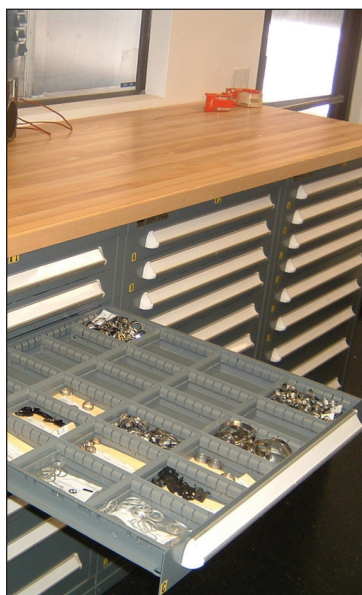
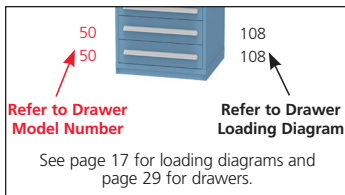

SCU1918AL
 5 Drawers
 88 Compartments
 Usable Drawer Heights
 2-1/4 in. (57 mm)
 3-7/8 in. (98 mm)
 5-3/8 in. (137 mm)
 11-3/4 in. (292 mm)
 330 lbs. (150 kg.) Shipping Weight

SCU1920AL
 4 Drawers
 48 Compartments
 Usable Drawer Height
 7 in. (178 mm)
 309 lbs. (140 kg.) Shipping Weight

SCU1927AL
 2 Drawers
 48 Compartments
 Usable Drawer Heights
 2-1/4 in. (57 mm)
 3 in. (76 mm)
 245 lbs. (111 kg.) Shipping Weight

CABINETS: Preconfigured Cabinets



| | | |
|----|---|----|
| 25 |  | 48 |
| 25 | | 58 |
| 25 | | 58 |
| 25 | | 68 |
| 25 | | 68 |
| 25 | | 88 |
| 25 | | 88 |

SEP1001AL
7 Drawers
152 Compartments
Usable Drawer Height
3 in. (76 mm)
388 lbs. (176 kg.) Shipping Weight

| | | |
|----|--|-----|
| 20 |  | 48 |
| 20 | | 58 |
| 20 | | 68 |
| 20 | | 88 |
| 30 | | 68 |
| 30 | | 88 |
| 35 | | 108 |

SEP1002AL
7 Drawers
140 Compartments
Usable Drawer Heights
2-1/4 in. (57 mm)
3-7/8 in. (98 mm)
4-5/8 in. (117 mm)
392 lbs. (178 kg.) Shipping Weight

| | | |
|----|---|-----|
| 20 |  | 58 |
| 20 | | 68 |
| 25 | | 88 |
| 30 | | 68 |
| 30 | | 88 |
| 50 | | 108 |

SEP1004AL
6 Drawers
108 Compartments
Usable Drawer Heights
2-1/4 in. (57 mm)
3 in. (76 mm)
3-7/8 in. (98 mm)
7 in. (178 mm)
361 lbs. (164 kg.) Shipping Weight

BENCH AND WORKSTATION HEIGHT

Model 175
33 in. (838 mm) high
30 in. (762 mm) wide
27-3/4 in. (705 mm) deep

To order cabinets without locks, delete the "L" suffix from the model number (example: SEP3014AL becomes SEP3014A).

| | | |
|----|--|-----|
| 20 |  | 58 |
| 20 | | 58 |
| 25 | | 58 |
| 30 | | 68 |
| 30 | | 68 |
| 50 | | 108 |

| | | |
|----|---|-----|
| 25 |  | 58 |
| 25 | | 68 |
| 30 | | 68 |
| 45 | | 88 |
| 50 | | 108 |

| | | |
|----|--|-----|
| 20 |  | 58 |
| 20 | | 68 |
| 40 | | 88 |
| 45 | | 108 |
| 50 | | 108 |

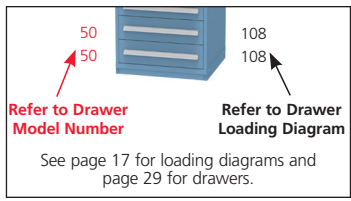

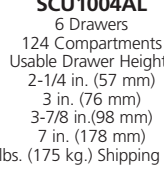
| | | |
|----|---|-----|
| 50 |  | 108 |
|----|---|-----|

SCU1004AL
6 Drawers
124 Compartments
Usable Drawer Heights
2-1/4 in. (57 mm)
3 in. (76 mm)
3-7/8 in. (98 mm)
7 in. (178 mm)
385 lbs. (175 kg.) Shipping Weight

| | | |
|----|--|-----|
| 25 |  | 58 |
| 25 | | 68 |
| 30 | | 68 |
| 45 | | 88 |
| 50 | | 108 |

SEP1016AL
5 Drawers
92 Compartments
Usable Drawer Heights
3 in. (76 mm)
3-7/8 in. (98 mm)
6-1/4 in. (159 mm)
7 in. (178 mm)
333 lbs. (151 kg.) Shipping Weight

| | | |
|----|---|-----|
| 20 |  | 58 |
| 20 | | 68 |
| 40 | | 88 |
| 45 | | 108 |
| 50 | | 108 |

SEP1019AL
5 Drawers
84 Compartments
Usable Drawer Heights
2-1/4 in. (57 mm)
5-3/8 in. (137 mm)
6-1/4 in. (159 mm)
7 in. (178 mm)
333 lbs. (151 kg.) Shipping Weight

| | | |
|----|---|-----|
| 20 |  | 58 |
| 25 | | 68 |
| 30 | | 68 |
| 40 | | 88 |
| 60 | | 108 |

SEP1023AL
5 Drawers
92 Compartments
Usable Drawer Heights
2-1/4 in. (57 mm)
3 in. (76 mm)
3-7/8 in. (98 mm)
5-3/8 in. (137 mm)
8-1/2 in. (216 mm)
334 lbs. (152 kg.) Shipping Weight

| | | |
|----|--|----|
| 30 |  | 68 |
| 30 | | 68 |
| 30 | | 68 |
| 40 | | 88 |
| 45 | | 88 |

SCU1012AL
5 Drawers
92 Compartments
Usable Drawer Heights
3-7/8 in. (98 mm)
5-3/8 in. (137 mm)
6-1/4 in. (159 mm)
330 lbs. (150 kg.) Shipping Weight

| | | |
|----|---|-----|
| 20 |  | 58 |
| 25 | | 58 |
| 30 | | 68 |
| 40 | | 88 |
| 60 | | 108 |

SCU1023AL
5 Drawers
96 Compartments
Usable Drawer Heights
2-1/4 in. (57 mm)
3 in. (76 mm)
3-7/8 in. (98 mm)
5-3/8 in. (137 mm)
8-1/2 in. (216 mm)
330 lbs. (150 kg.) Shipping Weight



SCU1010AL
5 Drawers
100 Compartments
Usable Drawer Height
4-5/8 in. (117 mm)
313 lbs. (142 kg.) Shipping Weight



SEP1031AL
4 Drawers
56 Compartments
Usable Drawer Heights
5-3/8 in. (137 mm)
6-1/4 in. (159 mm)
304 lbs. (138 kg.) Shipping Weight



SCU1043AL
3 Drawers
36 Compartments
Usable Drawer Heights
6-1/4 in. (159 mm)
8-1/2 in. (216 mm)
10-1/8 in. (257 mm)
267 lbs. (121 kg.) Shipping Weight



SCU1072AL
3 Drawers
40 Compartments
Usable Drawer Heights
2-1/4 in. (57 mm)
10-7/8 in. (276 mm)
11-3/4 in. (318 mm)
258 lbs. (117 kg.) Shipping Weight



SEP1045AL
2 Drawers
16 Compartments
Usable Drawer Heights
12-1/2 in. (318 mm)
13-1/4 in. (337 mm)
231 lbs. (105 kg.) Shipping Weight



SD175LH1
Left hinge
SD175RH1
Right hinge
2 Shelves
186 lbs. (84 kg.) Shipping Weight



CABINETS: Preconfigured Cabinets

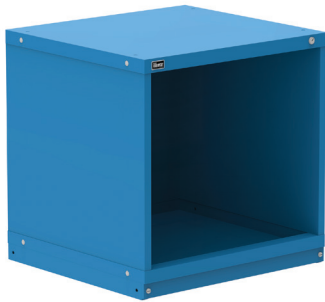

SEP1401AL
 6 Drawers
 136 Compartments
 Usable Drawer Heights
 3 in (76mm)
 3-7/8 in (98mm)
 295 lbs (133 kg) Shipping Weight



SEP1402AL
 6 Drawers
 132 Compartments
 Usable Drawer Heights
 2-1/4 in (57mm)
 3 in (76mm)
 6 -1/4 in (259 mm)
 298 lbs (135 kg) Shipping Weight



SEP1411AL
 3 Drawers
 40 Compartments
 Usable Drawer Heights
 4-5/8 in (117 mm)
 8-1/2 in (216 mm)
 219 lbs (99 kg) Shipping Weight

BENCH AND WORKSTATION HEIGHT

Model 155

30 in (762 mm) high
 30 in (762 mm) wide
 27-3/4 in (705 mm) deep

To order cabinets without locks, delete the "L" suffix from the model number (example: SEP3014AL becomes SEP3014A).



SEP1405AL
 4 Drawers
 68 Compartments
 Usable Drawer Heights
 2-1/4 in (57 mm)
 3-7/8 in (98 mm)
 4-5/8 in (117 mm)
 10-1/8 in (257 mm)
 246 lbs (111 kg) Shipping Weight



SEP1404AL
 4 Drawers
 56 Compartments
 Usable Drawer Heights
 4-5/8 in (117 mm)
 5-3/8 in (137 mm)
 255 lbs (115 kg) Shipping Weight



SEP1406AL
 3 Drawers
 28 Compartments
 Usable Drawer Heights
 7 in (178 mm)
 7-3/4 in (197 mm)
 219 lbs (99 kg) Shipping Weight

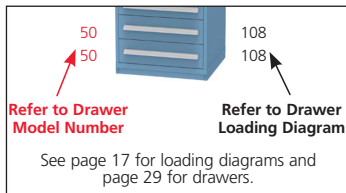

SEP1407AL
 2 Drawers
 16 Compartments
 Usable Drawer Heights
 10-7/8 in (276 mm)
 11-3/4 in (318 mm)
 184 lbs (83kg) Shipping Weight



SCU1701AL
 5 Drawers
 112 Compartments
 Usable Drawer Heights
 3 in (76 mm)
 3-7/8 in (98 mm)
 265 lbs (120 kg) Shipping Weight



SCU1702AL
 3 Drawers
 80 Compartments
 Usable Drawer Heights
 3-7/8 in (98 mm)
 4-5/8 in (117 mm)
 244 lbs (110kg) Shipping Weight



SCU1705AL
 3 Drawers
 48 Compartments
 Usable Drawer Heights
 3-7/8 in (98 mm)
 10-7/8 in (276 mm)
 212 lbs (96 kg) Shipping Weight

BENCH AND WORKSTATION HEIGHT

Model 135

27 in (686 mm) high
 30 in (762 mm) wide
 27-3/4 in (705 mm) deep

To order cabinets without locks, delete the "L" suffix from the model number (example: SEP3014AL becomes SEP3014A).



SCU1704AL
 3 Drawers
 48 Compartments
 Usable Drawer Heights
 2-1/4 in (57mm)
 7 in (178 mm)
 10-1/8 in (257 mm)
 209 lbs (94 kg) Shipping Weights



SCU1703AL
 3 Drawers
 48 Compartments
 Usable Drawer Heights
 6-1/4 in (159 mm)
 217 lbs (98 kg) Shipping Weight



SCU1707AL
 2 Drawers
 16 Compartments
 Usable Drawer Heights
 9-3/8 in (235 mm)
 10-1/8 in (257 mm)
 178 lbs (80 kg) Shipping Weight

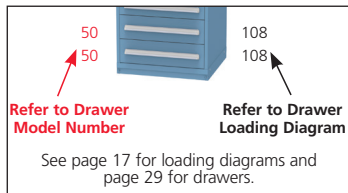

CABINETS: Preconfigured Cabinets

DRAWER INTERIORS FOR PRECONFIGURED CABINETS

Standard Loading Diagrams

- 28 proven drawer interiors

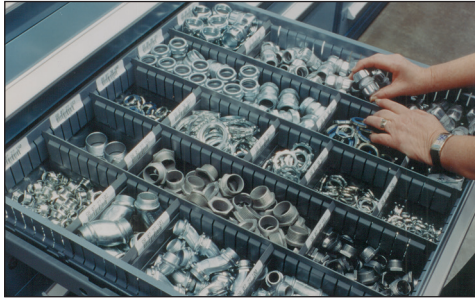

LD3232
1 Compartment
25-1/8 in. x 25-1/8 in.
(638 mm x 638 mm)

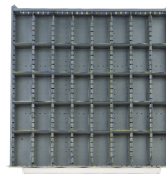

LD46
40 Compartments
2-5/8 in. x 4-5/8 in.
(67 mm x 117 mm)



LD510
18 Compartments
3-1/2 in. x 7-7/8 in.
(89 mm x 200 mm)



LD516
12 Compartments
3-1/2 in. x 12-1/2 in.
(89 mm x 318 mm)



LD48
32 Compartments
25/8 in. x 6-1/8 in.
(67 mm x 156 mm)



LD54
48 Compartments
3-1/2 in. x 2-7/8 in.
(89 mm x 73 mm)



LD56
30 Compartments
3-1/2 in. x 4-5/8 in.
(89 mm x 117 mm)



LD58
24 Compartments
3-1/2 in. x 6-1/8 in.
(89 mm x 156 mm)



LD65
30 Compartments
4-1/4 in. x 3-7/8 in.
(108 mm x 98 mm)



LD66
25 Compartments
4-1/4 in. x 4-5/8 in.
(108 mm x 117 mm)



LD68
20 Compartments
4-1/4 in. x 6-1/8 in.
(108 mm x 156 mm)



LD610
15 Compartments
4-1/4 in. x 7-7/8 in.
(108 mm x 200 mm)



BN-48
48 Bins
(32) 3 in. x 3 in.
(76 mm x 76 mm)
(16) 3 in. x 6-1/8 in.
(76 mm x 156 mm)



LD168
8 Compartments
12-1/4 in. x 6-1/8 in.
(311 mm x 156 mm)



LD86
20 Compartments
5-7/8 in. x 4-5/8 in.
(149 mm x 117 mm)



LD88
16 Compartments
5-7/8 in. x 6-1/8 in.
(149 mm x 156 mm)



LD810
12 Compartments
5-7/8 in. x 7-7/8 in.
(149 mm x 200 mm)



LD816
8 Compartments
5-7/8 in. x 12-1/2 in.
(149 mm x 318 mm)



LD84
32 Compartments
5-7/8 in. x 2-7/8 in.
(149 mm x 73 mm)



LD85
24 Compartments
5-7/8 in. x 3-7/8 in.
(149 mm x 98 mm)



LD1016
6 Compartments
7-1/2 in. x 12-1/2 in.
(191 mm x 318 mm)



LD1610
6 Compartments
12-1/4 in. x 7-7/8 in.
(311 mm x 200 mm)



BN-12 12 Bins:
(4) 6-1/8 in. x 12 in.
(156 mm x 305 mm)
(8) 6-1/8 in. x 6-1/8 in.
(156 mm x 156 mm)



BN-16 16 Bins:
(16) 6-1/8 in. x 6-1/8 in.
(156 mm x 156 mm)



LD108
12 Compartments
7-1/2 in. x 6-1/8 in.
(191 mm x 156 mm)



LD1010
9 Compartments
7-1/2 in. x 7-7/8 in.
(191 mm x 200 mm)



BN-24 24 Bins:
(8) 6-1/8 in. x 6-1/8 in.
(156 mm x 156 mm)
(16) 3 in. x 6-1/8 in.
(76 mm x 156 mm)



BN-32 32 Bins:
(32) 3 in. x 6-1/8 in.
(76 mm x 156 mm)



BN-64 64 Bins:
(64) 3 in. x 3 in.
(76 mm x 76 mm)



PS70
2 Hanging File
Compartments
12-1/4 in. x 25-1/8 in.
(311 mm x 638 mm)



25 68
25 68
25 68
25 68
25 68
25 68
25 68

RP1144AL
33 in. (838 mm) High
7 Drawers
105 Compartments
Usable Drawer Height
3 in. (76 mm)
306 lbs. (139 kg.) Shipping Weight



20 58
20 58
20 68
25 68
30 68
30 68
50 108

RP1145AL
33 in. (838 mm) High
6 Drawers
90 Compartments
Usable Drawer Heights
2-1/4 in. (57 mm)
3 in. (76 mm)
3-7/8 in. (98 mm)
7 in. (178 mm)
290 lbs. (135 kg.) Shipping Weight



20 58
25 58
30 68
40 88
60 108

RP1138AL
33 in. (838 mm) High
5 Drawers
72 Compartments
Usable Drawer Heights
2-1/4 in. (57 mm)
3 in. (76 mm)
3-7/8 in. (98 mm)
5-3/8 in. (137 mm)
8-1/2 in. (216 mm)
266 lbs. (121 kg.) Shipping Weight

SHALLOW DEPTH

30 in. (762 mm) wide
21-3/8 in. (543 mm) deep
Available in all standard heights

To order cabinets without locks, delete the "L" suffix from the model number (example: SEP3014AL becomes SEP3014A).



20 58
20 58
20 58
20 58
20 58
30 68
30 68
40 88

RP1941AL
37 in. (940 mm) High
8 Drawers
132 Compartments
Usable Drawer Heights
2-1/4 in. (57 mm)
3-7/8 in. (98 mm)
5-3/8 in. (137 mm)
432 lbs. (196 kg.) Shipping Weight



20 58
20 58
30 68
30 68
40 88
60 108

RP1942AL
37 in. (940 mm) High
6 Drawers
87 Compartments
Usable Drawer Heights
2-1/4 in. (57 mm)
3-7/8 in. (98 mm)
5-3/8 in. (137 mm)
8-1/2 in. (216 mm)
377 lbs. (171 kg.) Shipping Weight

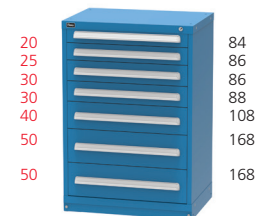

20 84
25 86
30 86
30 88
40 108
50 168
50 168

RP2144AL
44 in. (1118 mm) High
7 Drawers
89 Compartments
Usable Drawer Heights
2-1/4 in. (57 mm)
3 in. (76 mm)
3-7/8 in. (98 mm)
5-3/8 in. (137 mm)
7 in. (178 mm)
334 lbs. (152 kg.) Shipping Weight

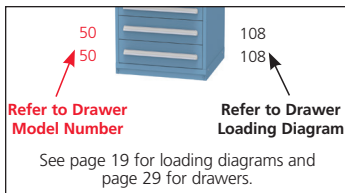

30 68
35 68
40 88
40 88
50 108
50 108

RP2145AL
44 in. (1118 mm) High
6 Drawers
72 Compartments
Usable Drawer Heights
3-7/8 in. (98 mm)
4-5/8 in. (117 mm)
5-3/8 in. (137 mm)
7 in. (178 mm)
320 lbs. (145 kg.) Shipping Weight

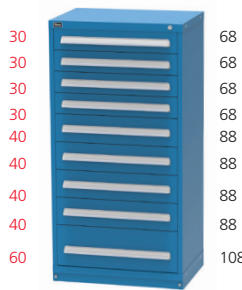

30 68
30 68
30 68
40 88
40 88
40 88
40 88
40 88
60 108

RP3504AL
59 in. (1499 mm) High
9 Drawers
117 Compartments
Usable Drawer Heights
3-7/8 in. (98 mm)
5-3/8 in. (137 mm)
8-1/2 in. (216 mm)
440 lbs. (200 kg.) Shipping Weight



50 108
60 108
70 812
70 812
90 812

RP3503AL
59 in. (1499 mm) High
5 Drawers
42 Compartments
Usable Drawer Heights
7 in. (178 mm)
8-1/2 in. (216 mm)
10-1/8 in. (257 mm)
13-1/4 in. (337 mm)
323 lbs. (147 kg.) Shipping Weight

CABINETS: Preconfigured Cabinets

DRAWER INTERIORS FOR PRECONFIGURED SHALLOW DEPTH CABINETS

Shallow Depth Loading Diagrams

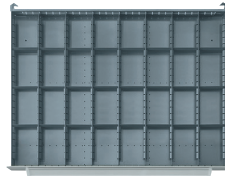

LDLW46
32 Compartments
2-5/8 in. x 4-1/2 in.
(67 mm x 114 mm)

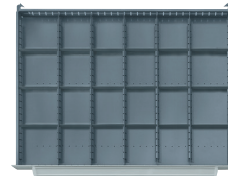

LDLW56
24 Compartments
3-1/2 in. x 4-1/2 in.
(89 mm x 114 mm)



LDLW58
18 Compartments
3-1/2 in. x 6-1/8 in.
(89 mm x 156 mm)

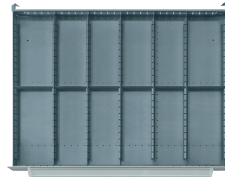

LDLW512
12 Compartments
3-1/2 in. x 9-1/4 in.
(89 mm x 235 mm)

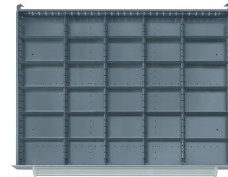

LDLW64
30 Compartments
4-1/2 in. x 2-7/8 in.
(114 mm x 73 mm)

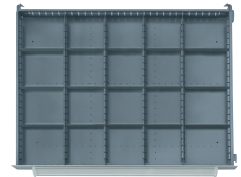

LDLW66
20 Compartments
4-1/4 in. x 4-1/2 in.
(108 mm x 114 mm)

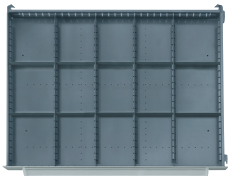

LDLW68
15 Compartments
4-1/4 in. x 6-1/8 in.
(108 mm x 156 mm)



LDLW612
10 Compartments
4-1/4 in. x 9-1/4 in.
(108 mm x 235 mm)



LDLW84
24 Compartments
5-7/8 in. x 2-7/8 in.
(149 mm x 73 mm)



LDLW86
16 Compartments
5-7/8 in. x 4-1/2 in.
(149 mm x 114 mm)



LDLW88
12 Compartments
5-7/8 in. x 6-1/8 in.
(149 mm x 156 mm)



LDLW812
8 Compartments
5-7/8 in. x 9-1/4 in.
(149 mm x 235 mm)



LDLW106
12 Compartments
7-1/2 in. x 4-1/2 in.
(191 mm x 114 mm)



LDLW108
9 Compartments
7-1/2 in. x 6-1/8 in.
(191 mm x 156 mm)

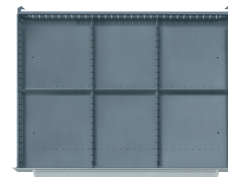

LDLW1012
6 Compartments
7-1/2 in. x 9-1/4 in.
(191 mm x 235 mm)



LDLW166
8 Compartments
12-1/2 in. x 4-1/2 in.
(318 mm x 114 mm)



LDLW168
6 Compartments
12-1/2 in. x 6-1/8 in.
(318 mm x 156 mm)



LDLW1612
4 Compartments
12-1/2 in. x 9-1/4 in.
(318 mm x 235 mm)



LDLW68L
16 Compartments
4-1/4 in. x 6-1/8 in.
(108 mm x 156 mm)



LDLW84L
24 Compartments
5-7/8 in. x 2-7/8 in.
(149 mm x 73 mm)



LDLW88L
12 Compartments
5-7/8 in. x 6-1/8 in.
(149 mm x 156 mm)

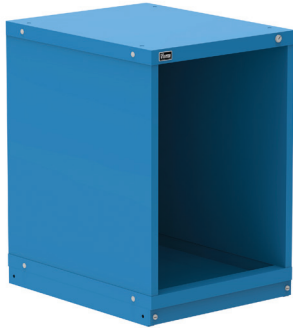

RP1135AL
33 in. (838 mm) High
Usable Drawer Height
3 in. (76 mm)
322 lbs. (146 kg.) Shipping Weight



RP1134AL
33 in. (838 mm) High
6 Drawers
88 Compartments
Usable Drawer Heights
2-1/4 in. (57 mm)
3 in. (76 mm)
3-7/8 in. (98 mm)
7 in. (178 mm)
304 lbs. (138 kg.) Shipping Weight

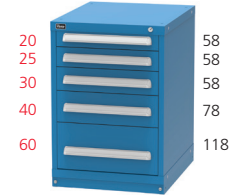

RP1136AL
33 in. (838 mm) High
5 Drawers
68 Compartments
Usable Drawer Heights
2-1/4 in. (57 mm)
3 in. (76 mm)
3-7/8 in. (98 mm)
5-3/8 in. (137 mm)
8-1/2 in. (216 mm)
279 lbs. (127 kg.) Shipping Weight

SMALL VERSION

22-1/2 in. (572 mm) wide
27-3/4 in. (705 mm) deep
Available in all standard heights.

To order cabinets without locks, delete the "L" suffix from the model number (example: SEP3014AL becomes SEP3014A).



RP1940AL
37 in. (940 mm) High
7 Drawers
100 Compartments
Usable Drawer Heights
2-1/4 in. (57 mm)
3-7/8 in. (98 mm)
5-3/8 in. (137 mm)
7 in. (178 mm)
343 lbs. (156 kg.) Shipping Weight



RP1939AL
37 in. (940 mm) High
6 Drawers
96 Compartments
Usable Drawer Heights
3-7/8 in. (98 mm)
5-3/8 in. (137 mm)
323 lbs. (147 kg.) Shipping Weight



RP2143AL
44 in. (1118 mm) High
6 Drawers
72 Compartments
Usable Drawer Heights
3-7/8 in. (98 mm)
4-5/8 in. (117 mm)
5-3/8 in. (137 mm)
7 in. (178 mm)
339 lbs. (154 kg.) Shipping Weight

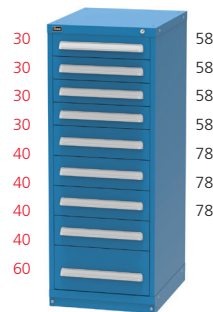
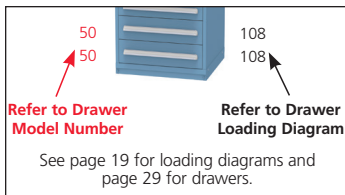

RP3501AL
59 in. (1499 mm) High
9 Drawers
120 Compartments
Usable Drawer Heights
3-7/8 in. (98 mm)
5-3/8 in. (137 mm)
8-1/2 in. (216 mm)
461 lbs. (209 kg.) Shipping Weight

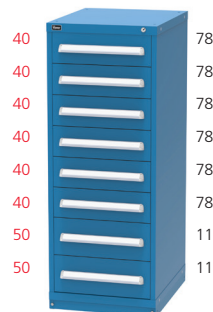

RP3500AL
59 in. (1499 mm) High
8 Drawers
88 Compartments
Usable Drawer Heights
5-3/8 in. (137 mm)
7 in. (178 mm)
432 lbs. (196 kg.) Shipping Weight

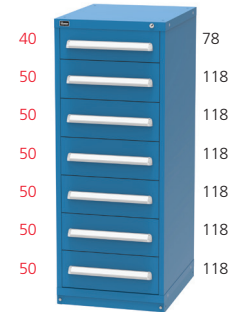

RP3502AL
59 in. (1499 mm) High
7 Drawers
60 Compartments
Usable Drawer Heights
5-3/8 in. (137 mm)
7 in. (178 mm)
400 lbs. (181 kg.) Shipping Weight

CABINETS: Preconfigured Cabinets

DRAWER INTERIORS FOR PRECONFIGURED SMALL VERSION CABINETS

Small Version Loading Diagrams



LDSV54
32 Compartments
3-1/2 in. x 2-7/8 in.
(89 mm x 73 mm)



LDSV56
20 Compartments
3-1/2 in. x 4-5/8 in.
(89 mm x 117 mm)



LDSV58
16 Compartments
3-1/2 in. x 6-1/8 in.
(89 mm x 156 mm)



LDSV510
12 Compartments
3-1/2 in. x 7-7/8 in.
(89 mm x 200 mm)

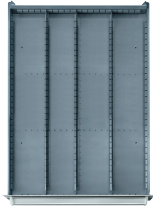

LDSV532
4 Compartments
3 1/2 in. x 25 1/8 in.
(89 mm x 638 mm)



LDSV74
24 Compartments
5-1/8 in. x 2-7/8 in.
(130 mm x 73 mm)



LDSV76
15 Compartments
5-1/8 in. x 4-5/8 in.
(130 mm x 117 mm)



LDSV78
12 Compartments
5-1/8 in. x 6-1/8 in.
(130 mm x 156 mm)



LDSV710
9 Compartments
5-1/8 in. x 7-7/8 in.
(130 mm x 200 mm)



LDSV732
3 Compartments
5-1/8 in. x 25-1/8 in.
(130 mm x 638 mm)



LDSV114
16 Compartments
8-1/4 in. x 2-7/8 in.
(210 mm x 73 mm)



LDSV116
10 Compartments
8-1/4 in. x 4-5/8 in.
(210 mm x 117 mm)



LDSV118
8 Compartments
8-1/4 in. x 6-1/8 in.
(210 mm x 156 mm)

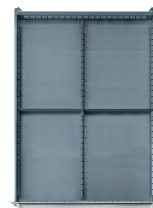

LDSV1116
4 Compartments
8-1/4 in. x 12-1/2 in.
(210 mm x 318 mm)

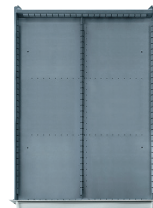

LDSV1132
2 Compartments
8-1/4 in. x 25-1/8 in.
(210 mm x 638 mm)

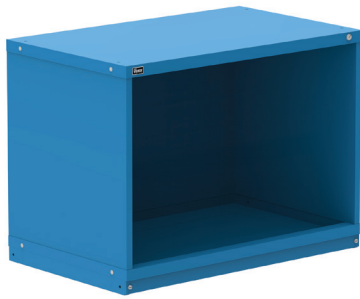

RP1147AL
 33 in. (838 mm) High
 6 Drawers
 204 Compartments
 Usable Drawer Heights
 2-1/4 in. (57 mm)
 3 in. (76 mm)
 3-7/8 in. (98 mm)
 7 in. (178 mm)
 527 lbs. (239 kg.) Shipping Weight



RP1146AL
 33 in. (838 mm) High
 5 Drawers
 156 Compartments
 Usable Drawer Heights
 2-1/4 in. (57 mm)
 3 in. (76 mm)
 3-7/8 in. (98 mm)
 5-3/8 in. (137 mm)
 8-1/2 in. (216 mm)
 483 lbs. (219 kg.) Shipping Weight



RP1943AL
 37 in. (940 mm) High
 2 Drawers
 1 Bottom Pan
 64 Compartments
 Usable Drawer Heights
 3-7/8 in. (98 mm)
 4-5/8 in. (117 mm)
 366 lbs. (166 kg.) Shipping Weight

EXTRA-WIDE

45 in. (1143 mm) wide
 27-3/4 in. (705 mm) deep
 Available in all standard heights.

To order cabinets without locks, delete the "L" suffix from the model number (example: SEP3014AL becomes SEP3014A).

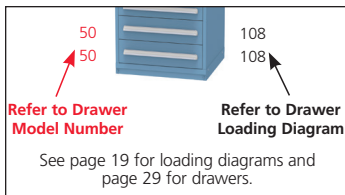

RP2147AL
 44 in. (1118 mm) High
 6 Drawers
 152 Compartments
 Usable Drawer Heights
 3-7/8 in. (98 mm)
 4-5/8 in. (117 mm)
 5-3/8 in. (137 mm)
 7 in. (178 mm)
 579 lbs. (263 kg.) Shipping Weight



RP2146AL
 44 in. (1118 mm) High
 5 Drawers
 140 Compartments
 Usable Drawer Heights
 3 in. (76 mm)
 5-3/8 in. (137 mm)
 7 in. (178 mm)
 11-3/4 in. (292 mm)
 531 lbs. (241 kg.) Shipping Weight

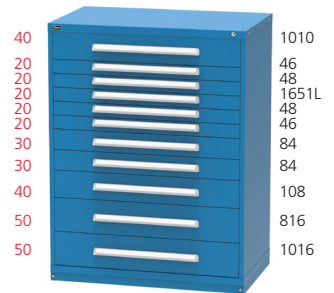

RP3505AL
 59 in. (1499 mm) High
 11 Drawers
 371 Compartments
 Usable Drawer Heights
 2-1/4 in. (57 mm)
 3-7/8 in. (98 mm)
 5-3/8 in. (137 mm)
 7 in. (178 mm)
 866 lbs. (393 kg.) Shipping Weight

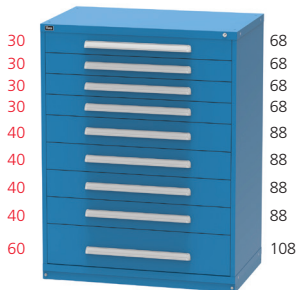

RP3506AL
 59 in. (1499 mm) High
 9 Drawers
 244 Compartments
 Usable Drawer Heights
 3-7/8 in. (98 mm)
 5-3/8 in. (137 mm)
 8-1/2 in. (216 mm)
 797 lbs. (362 kg.) Shipping Weight



RP3507AL
 59 in. (1499 mm) High
 4 Drawers
 1 Roll out XWRS20
 8 Compartments
 Usable Drawer Heights
 2-1/4 in. (57 mm)
 11-3/4 in. (292 mm)
 492 lbs. (223 kg.) Shipping Weight



RP3508AL
 59 in. (1499 mm) High
 5 Drawers
 88 Compartments
 Usable Drawer Heights
 7 in. (178 mm)
 8-1/2 in. (216 mm)
 10-1/8 in. (257 mm)
 13-1/4 in. (337 mm)
 578 lbs. (262 kg.) Shipping Weight

CABINETS: Preconfigured Cabinets

DRAWER INTERIORS FOR PRECONFIGURED EXTRA-WIDE CABINETS

Extra-Wide Loading Diagrams

An "L" suffix added to the end of a loading diagram model number indicates that the partitions run left to right.



LDXW46
60 Compartments
2-5/8 in. x 4-5/8 in.
(67 mm x 117 mm)



LDXW48
48 Compartments
2-5/8 in. x 6-1/8 in.
(67 mm x 156 mm)



LDXWPS70
3 Hanging File
Compartments
12-1/4 in. 18-3/4 in.
(311 mm x 476 mm)



LDXW58
40 Compartments
3-1/2 in. x 6-1/8 in.
(89 mm x 156 mm)



LDXW68
32 Compartments
4-1/4 in. x 6-1/8 in.
(108 mm x 156 mm)



LDXW128
16 Compartments
9 in. x 6-1/8 in.
(228 mm x 156 mm)



LDXW84
48 Compartments
5-7/8 in. x 2-7/8 in.
(149 mm x 73 mm)



LDXW88
24 Compartments
5-7/8 in. x 6-1/8 in.
(149 mm x 156 mm)



LDXW816
12 Compartments
5-7/8 in. x 12-1/2 in.
(149 mm x 318 mm)



LDXW108
20 Compartments
7-1/2 in. x 6-1/8 in.
(191 mm x 156 mm)



LDXW1010
15 Compartments
7-1/2 in. x 7-7/8 in.
(191 mm x 200 mm)



LDXW1016
10 Compartments
7-1/2 in. x 12-1/2 in.
(191 mm x 318 mm)



LDXW46L
64 Compartments
2-5/8 in. x 4-5/8 in.
(67 mm x 117 mm)



LDXW451L
8 Compartments
2-5/8 in. x 40-1/4 in.
(67 mm x 1022 mm)



LDXW48L
48 Compartments
2-5/8 in. x 6-1/4 in.
(67 mm x 159 mm)



LDXW551L
6 Compartments
3-1/2 in. x 40-1/4 in.
(89 mm x 1022 mm)



LDXW58L
36 Compartments
3-1/2 in. x 6-1/4 in.
(89 mm x 159 mm)



LDXW651L
5 Compartments
4-1/4 in. x 40-1/4 in.
(108 mm x 1022 mm)



LDXW68L
30 Compartments
4-1/4 in. x 6-1/4 in.
(108 mm x 159 mm)



LDXW84L
48 Compartments
5-7/8 in. x 3 in.
(149 mm x 76 mm)



LDXW851L
4 Compartments
5-7/8 in. x 40-1/4 in.
(149 mm x 1022 mm)



LDXW88L
24 Compartments
5-7/8 in. x 6-1/4 in.
(149 mm x 159 mm)



LDXW1010L
15 Compartments
7-1/2 in. x 7-5/8 in.
(191 mm x 194 mm)



LDXW1051L
3 Compartments
7-1/2 in. x 40-1/4 in.
(191 mm x 1022 mm)



LDXW108L
18 Compartments
7-1/2 in. x 6-1/4 in.
(191 mm x 159 mm)



LDXW1651L
2 Compartments
12-1/2 in. x 40-1/4 in.
(318 mm x 1022 mm)

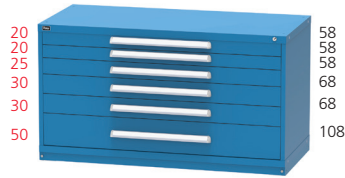

RP1148AL
 33 in. (838 mm) High
 6 Drawers
 284 Compartments
 Usable Drawer Heights
 2-1/4 in. (57 mm)
 3 in. (76 mm)
 3-7/8 in. (98 mm)
 7 in. (178 mm)
 666 lbs. (302 kg.) Shipping Weight

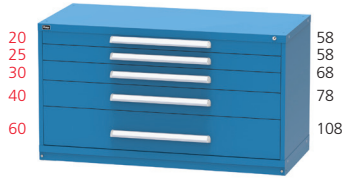

RP1149AL
 33 in. (838 mm) High
 5 Drawers
 224 Compartments
 Usable Drawer Heights
 2-1/4 in. (57 mm)
 3 in. (76 mm)
 3-7/8 in. (98 mm)
 5-3/8 in. (137 mm)
 8-1/2 in. (216 mm)
 621 lbs. (282 kg.) Shipping Weight



RP1944AL
 37 in. (940 mm) High
 6 Drawers
 268 Compartments
 Usable Drawer Heights
 2-1/4 in. (57 mm)
 3-7/8 in. (98 mm)
 5-3/8 in. (137 mm)
 8-1/2 in. (216 mm)
 694 lbs. (315 kg.) Shipping Weight

DOUBLE-WIDE

60 in. (1524 mm) wide
 27-3/4 in. (705 mm) deep
 Available in all standard heights.

To order cabinets without locks, delete the "L" suffix from the model number (example: SEP3014AL becomes SEP3014A).

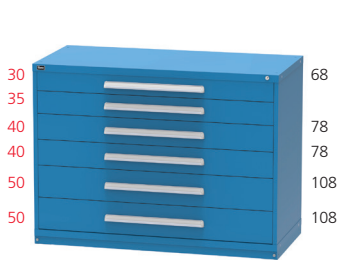
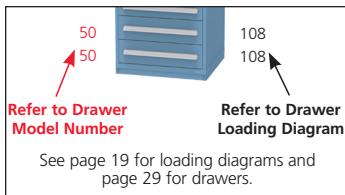

RP2148AL
 44 in. (1118 mm) High
 6 Drawers
 224 Compartments
 Usable Drawer Heights
 3-7/8 in. (98 mm)
 4-5/8 in. (117 mm)
 5-3/8 in. (137 mm)
 7 in. (178 mm)
 747 lbs. (339 kg.) Shipping Weight

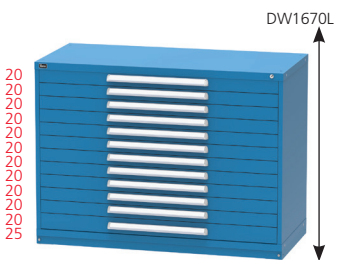

RP2149AL
 44 in. (1118 mm) High
 12 Drawers
 24 Compartments
 Usable Drawer Heights
 2-1/4 in. (57 mm)
 3 in. (76 mm)
 905 lbs. (411 kg.) Shipping Weight



RP3511AL
 59 in. (1499 mm) High
 9 Drawers
 364 Compartments
 Usable Drawer Heights
 3-7/8 in. (98 mm)
 5-3/8 in. (137 mm)
 8-1/2 in. (216 mm)
 989 lbs. (449 kg.) Shipping Weight

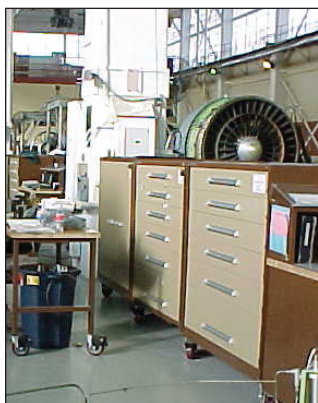

RP3510AL
 59 in. (1499 mm) High
 5 Drawers
 86 Compartments
 Usable Drawer Heights
 7 in. (178 mm)
 8-1/2 in. (216 mm)
 10-1/8 in. (257 mm)
 13-1/4 in. (337 mm)
 725 lbs. (329 kg.) Shipping Weight

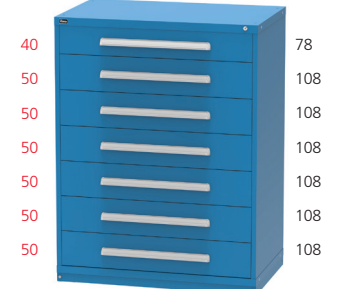

RP3512AL
 59 in. (1499 mm) High
 7 Drawers
 208 Compartments
 Usable Drawer Heights
 5-3/8 in. (137 mm)
 7 in. (178 mm)
 893 lbs. (405 kg.) Shipping Weight



RP3509AL
 59 in. (1499 mm) High
 6 Drawers
 144 Compartments
 Usable Drawer Heights
 6-1/4 in. (159 mm)
 7 in. (178 mm)
 8-1/2 in. (216 mm)
 11-3/4 in. (292 mm)
 797 lbs. (362 kg.) Shipping Weight

CABINETS: Preconfigured Cabinets

DRAWER INTERIORS FOR PRECONFIGURED DOUBLE-WIDE CABINETS

Double-Wide Loading Diagrams

An "L" suffix added to the end of a loading diagram model number indicates that the partitions run left to right.



LDDW58
56 Compartments
3-1/2 in. x 6-1/8 in.
(89 mm x 156 mm)



LDDW68
44 Compartments
4-1/4 in. x 6-1/8 in.
(108 mm x 156 mm)



LDDW78
40 Compartments
5-1/8 in. x 6-1/8 in.
(130 mm x 156 mm)



LDDW108
28 Compartments
7-1/2 in. x 6-1/8 in.
(191 mm x 156 mm)



LDDW470L
8 Compartments
2-5/8 in. x 55-3/8 in.
(67 mm x 1407 mm)



LDDW570L
6 Compartments
3-1/2 in. x 55-3/8 in.
(89 mm x 1047 mm)

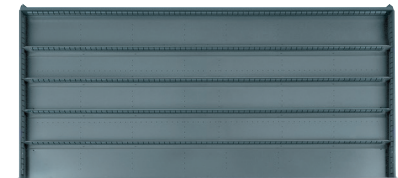

LDDW670L
5 Compartments
4-1/4 in. x 55-3/8 in.
(108 mm x 1047 mm)



LDDW870L
4 Compartments
5-7/8 in. x 55-3/8 in.
(149 mm x 1047 mm)



LDDW1070L
3 Compartments
7-1/2 in. x 55-3/8 in.
(191 mm x 1047 mm)

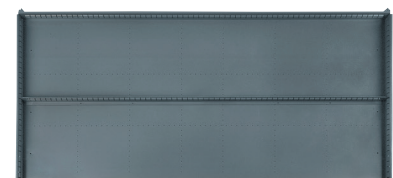

LDDW1670L
2 Compartments
12-1/4 in. x 55-3/8 in.
(311 mm x 1047 mm)

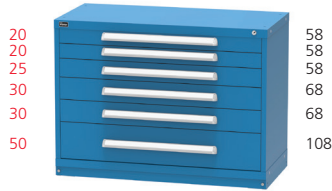

RP1171AL
 33 in. (838 mm) High
 6 Drawers
 153 Compartments
 Usable Drawer Heights
 2-1/4 in. (57 mm)
 3 in. (76 mm)
 3-7/8 in. (98 mm)
 7 in. (178 mm)
 377 lbs. (171 kg.) Shipping Weight



RP2151AL
 44 in. (1118 mm) High
 6 Drawers
 114 Compartments
 Usable Drawer Heights
 3-7/8 in. (98 mm)
 4-5/8 in. (117 mm)
 5-3/8 in. (137 mm)
 7 in. (178 mm)
 430 lbs. (195 kg.) Shipping Weight

EXTRA-WIDE SHALLOW DEPTH

45 in. (1143 mm) wide
 21-3/8 in. (543 mm) deep

To order cabinets without locks, delete the "L" suffix from the model number (example: SEP3014AL becomes SEP3014A).

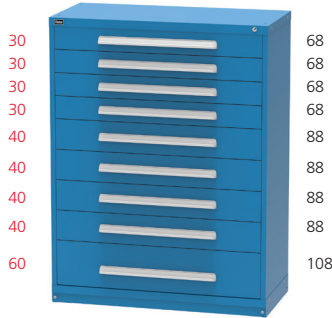

RP3520AL
 59 in. (1499 mm) High
 9 Drawers
 183 Compartments
 Usable Drawer Heights
 3-7/8 in. (98 mm)
 5-3/8 in. (137 mm)
 8-1/2 in. (216 mm)
 637 lbs. (289 kg.) Shipping Weight



RP3521AL
 59 in. (1499 mm) High
 5 Drawers
 66 Compartments
 Usable Drawer Heights
 7 in. (178 mm)
 8-1/2 in. (216 mm)
 10-1/8 in. (257 mm)
 13-1/4 in. (337 mm)
 428 lbs. (194 kg.) Shipping Weight

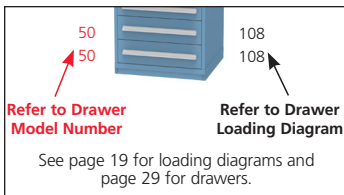

CABINETS: Preconfigured Cabinets

DRAWER INTERIORS FOR PRECONFIGURED EXTRA-WIDE SHALLOW DEPTH CABINETS

Extra-Wide Shallow Depth Loading Diagrams

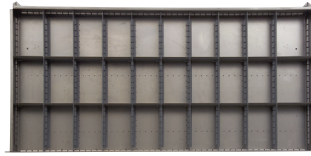

LDXL58
30 Compartments
(27) 3-1/2 in. x 6-1/8 in.
(89 mm x 156 mm)
(3) 4-1/4 in. x 6-1/8 in.
(108 mm x 156 mm)



LDXL68
24 Compartments
4-1/4 in. x 6-1/8 in.
(108 mm x 156 mm)



LDXL88
18 Compartments
5-7/8 in. x 6-1/8 in.
(149 mm x 156 mm)



LDXL108
15 Compartments
7-1/2 in. x 6-1/8 in.
(191 mm x 156 mm)



LDXL128
12 Compartments
9 in. x 4-5/8 in.
(229 mm x 118 mm)



Parts Storage



Issue Counter



Cabinets

1. SELECT HOUSING FOOTPRINT:

For example: ST = 30" W x 27-3/4" D

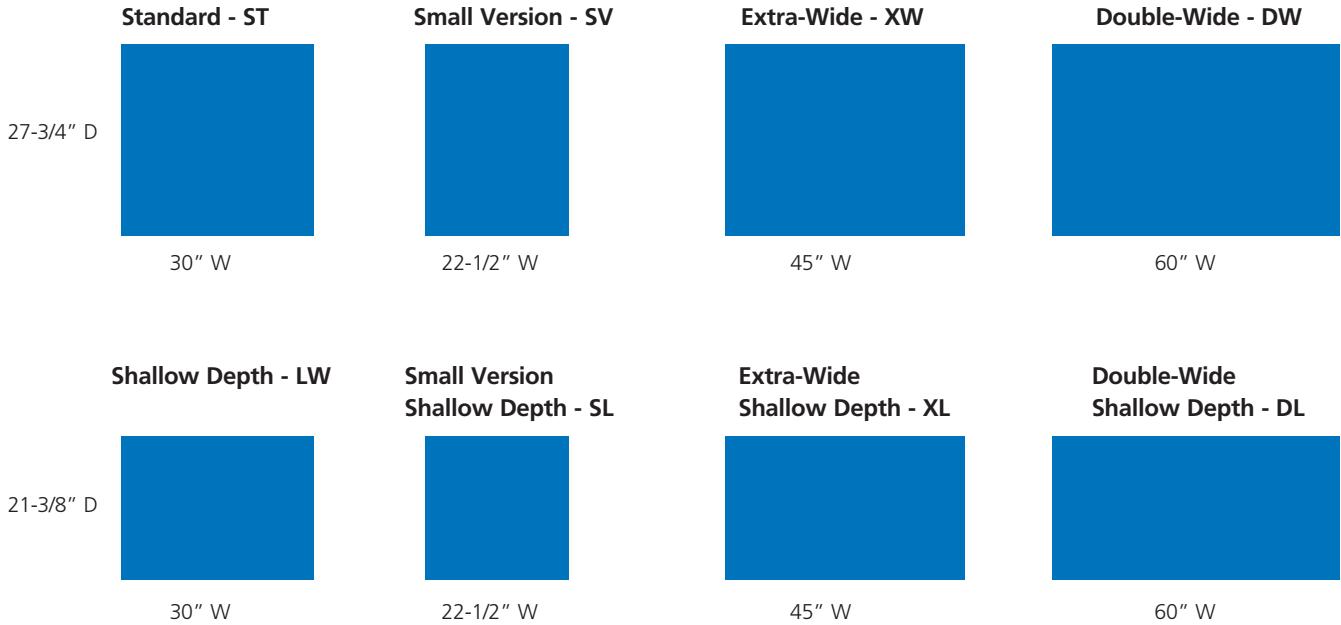

2. SELECT HOUSING HEIGHT:

For example: 0340 = 59" H

The complete housing model number is ST0340



CABINETS: How to Configure

3. CHOOSE YOUR DRAWERS:

THE DRAWER CAPACITY IS 400 LBS EACH

The drawer model numbers add up to the housing model number, for example:

| | | |
|-------|----|---|
| 20 | 20 |  |
| 20 | 20 | |
| 30 | 30 | |
| 30 | 30 | |
| 30 | 30 | |
| 30 | 30 | |
| 30 | 50 | |
| 50 | 50 | |
| 50 | 80 | |
| 80 | 80 | |
| = 340 | | ST340 |

Now you have configured your cabinet. For drawer interiors or accessories go to page 34. For further assistance please contact your local Territory Sales Manager or visit us on the web at STANLEYVidmar.com

- Model 20
- Model 25
- Model 30
- Model 35
- Model 40
- Model 45
- Model 50
- Model 55
- Model 60
- Model 65
- Model 70
- Model 75
- Model 80
- Model 85
- Model 90
- Model 95
- Model 100
- Model 105
- Model 110
- Model 115
- Model 120
- Model 125
- Model 130
- Model 135
- Model 140
- Model 145
- Model 150

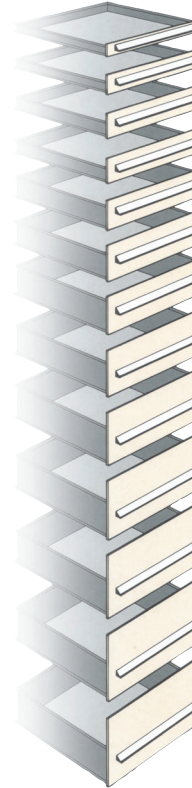

| STANDARD (STD) | USABLE HEIGHT "C" |
|----------------|-------------------|
| 20 | 2-1/4" |
| 25 | 3 |
| 30 | 3-7/8" |
| 35 | 4-5/8" |
| | |
| 40 | 5-3/8" |
| 45 | 6-1/4" |
| | |
| 50 | 7" |
| 55 | 7-3/4" |
| 60 | 8-1/2" |
| 65 | 9-3/8" |
| 70 | 10-1/8" |
| 75 | 10-7/8" |
| 80 | 11-3/4" |
| 85 | 12-1/2" |
| | |
| 90 | 13-1/4" |
| 95 | 14-1/4" |
| 100 | 14-7/8" |
| 105 | 15-5/8" |
| 110 | 16-3/8" |
| 115 | 17-1/4" |
| 120V | 18-1/8" |
| 125 | 18-7/8" |
| 130 | 19-5/8" |
| 135 | 20-3/8" |
| 140 | 21-1/8" |
| 145 | 21-7/8" |
| 150 | 22-3/4" |



Fully Optimized and Organized

MASTER LOCKING SYSTEM

- Create custom locking and access for cabinets and drawers
- Secure as few as one drawer or several cabinets with a single lock



Master Locking System

Cabinet Locks

| MODEL # | USED WITH CABINETS |
|---------|---|
| SL10 | Standard, Small Version, Extra-Wide, Double-Wide, Standard Under-Bench, Small Version Under-Bench |
| LWSSL10 | Shallow Depth, Extra-Wide Shallow Depth, Double-Wide Shallow Depth, Small Version Shallow Depth |
| NRKF | Non-removable key feature |
| Key1 | Key |
| Key2 | Master key |

Provide order in writing for these items.

HINGE LOCK BARS

- Hinge lock, double-action bar must be lifted and swung out of the way to access drawers
- May be secured with a single padlock. (Padlocks not included.)
- Bars provide extra security; use in mobile/shipboard applications
- Hinge lock bars on XW, XL, DL, and DW shelf door cabinets are center-mounted on double doors



Hinge Lock Bar

Hinge Lock Bars

| MODEL # | MODEL # | HEIGHT | USED WITH CABINET STYLES |
|-----------|------------|--------|-----------------------------------|
| LEFT-HAND | RIGHT-HAND | | |
| HLBL1351 | HLBR1351 | 135 | STD, LW, SV, SL, XW, XL, DW, DL |
| | HLBR1353 | 135 | XW, DW, XL, DL (SD Cabinets Only) |
| HLBL1551 | HLBR1551 | 155 | STD, LW, SV, SL, XW, XL, DW, DL |
| | HLBR1553 | 155 | XW, DW, XL, DL (SD Cabinets Only) |
| HLBL1751 | HLBR1751 | 175 | STD, LW, SV, SL, XW, XL, DW, DL |
| | HLBR1753 | 175 | XW, DW, XL, DL (SD Cabinets Only) |
| HLBL2001 | HLBR2001 | 200 | STD, LW, SV, SL, XW, XL, DW, DL |
| | HLBR2003 | 200 | XW, DW, XL, DL (SD Cabinets Only) |
| HLBL2451 | HLBR2451 | 245 | STD, LW, SV, SL, XW, XL, DW, DL |
| | HLBR2453 | 245 | XW, DW, XL, DL (SD Cabinets Only) |
| HLBL3401 | HLBR3401 | 340 | STD, LW, SV, SL, XW, DW, XL, DL |
| | HLBR3403 | 340 | XW, DW, XL, DL (SD Cabinets Only) |

KEY PAD LOCK

- Able to program up to 25 different user codes
- Eliminates lost keys
- retrofittable into existing Vidmar drawer cabinets



Key Pad Lock

Key Pad Lock

| MODEL # | DESCRIPTION |
|---------|------------------------|
| KPL-STD | Keypad Lock, STD depth |
| KPL-STD | Keypad Lock, STD depth |

SLING PICKUP FEATURE

- The sling pickup feature consists of four threaded steel blocks welded to columns inside the cabinet
- Blocks accept four eye bolts (supplied) so that cabinet can be lifted fully loaded (6,800 lbs.)
- Cabinets should be ordered with lock-in/lock-out latches and be banded when moved



Sling Pickup

CABINETS: Housing Features & Accessories

SPOOL FEATURE

- Includes a left and right hanging bracket and a spool bar
- Ideal for handling rolls of wire or for hangers



Spool Feature

RECESSED BASES

- Provide additional toe space at work or issue areas 3" (76mm) high



Recessed Bases

Recessed Bases

| MODEL # | DESCRIPTION |
|---------|--------------------------------------|
| RB1 | One Standard |
| RB2 | Two Standard or One Double-Wide |
| LWRB1 | One Shallow Depth |
| SVRB1 | One Small Version |
| SVRB2 | Two Small Versions |
| XWRB1 | One Extra-Wide or Two Small Versions |
| XLRB1 | One Extra-Wide Shallow Depth |
| DWRB1 | One Double-Wide |

KICK PLATES

- Protect outside floor level surfaces of a cabinet
- Kick plates are stainless steel, 7" (178mm) high
- Mounted directly to the cabinet with hardware provided
- Ideal for parts issue or high-traffic areas

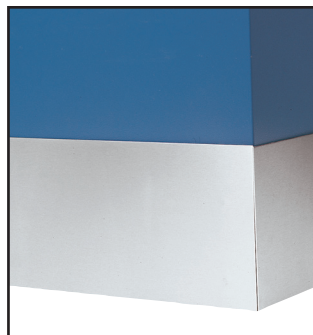

Kick Plates

Kick Plates

| MODEL # | DESCRIPTION |
|---------|--|
| KP1 | One Standard or Shallow Depth |
| KP2 | Two Standard, Shallow Depth, Double-Wide |
| KP6C | Corner Desk |
| XWKP1 | One Extra-Wide or Extra-Wide Shallow Depth |
| SVKP1 | One Small Version |

FOUR-WAY PALLET BASE

- Allows forklift entry from all sides of cabinet
- Cabinets should be banded when moved



Four-Way Pallet Base

Four-Way Pallet Base

| MODEL # | FOR USE WITH HOUSINGS |
|---------|--------------------------|
| PB4ST | Standard |
| PB4XW | Extra-Wide |
| PB4DW | Double-Wide |
| PB4C | Covers (Two Per Set) |
| PB4XL | Extra-Wide Shallow Depth |
| PB4SV | Small Version |
| PB4LW | Shallow Depth |

SECURITY DRAWER AND TOP PANEL

- Individual, key-activated security drawer locks can lock a specific drawer independent of cabinet locks
- Security panels, provided with all security locks except for top drawer, prevent access even when drawer above is removed
- Recommended for personal storage or inventory storage in high-traffic areas
- In XW and DW drawers only, security panel uses an additional five points of space in the housing (ex. a DW40SECL requires an opening of 45 points)
- Security locks are available for drawer models 25 and larger



Security Drawer and Panel

Security Drawer Top Feature

| MODEL # | DESCRIPTION |
|---------|--|
| XXSECR | Right-hand side of drawer |
| XXSECL | Left-hand side of drawer |
| XXSECRL | Right-hand and left-hand sides of drawer |
| SECP1 | Standard security panel only |

SINGLE DRAWER RELEASE

- Patented technology prevents opening more than one drawer at a time
- Release mechanism feature ensures that only one drawer will be open at a time—no other drawers can be opened
- Do not use for vehicular or shipboard applications

Single Drawer Release (Not Pictured)

| MODEL # | DESCRIPTION |
|---------|-------------------|
| SDR0135 | All 0135 Cabinets |
| SDR0155 | All 0155 Cabinets |
| SDR0175 | All 0175 Cabinets |
| SDR0200 | All 0200 Cabinets |
| SDR0245 | All 0245 Cabinets |
| SDR0340 | All 0340 Cabinets |

INDIVIDUAL DRAWER PADLOCK FEATURE

Model # DPF1

- Padlock feature allows a single drawer 30 points or larger, to be locked by a padlock with a latch plate connected to the cabinet and extending through a slot in the face of the drawer
- Available for left, right, or both sides of drawer
- Security panel (SECP1) is recommended for use with this feature to prevent access even when drawer above is removed
- Padlock not included



Individual Drawer Padlock

CABINETS: Drawer Features & Accessories

LOCK-IN/LOCK-OUT LATCHES

- Lock-in/lock-out latches prevent drawers from moving when fully opened or closed
- Raising the latch releases the drawer
- Mandatory for cabinets used in ships, vans, and mobile applications
- Modified drawer fronts require factory installation



Lock-In/Lock-Out Latch



Lock-In/Lock-Out Latches

| MODEL # | LOCATION |
|---------|--|
| XXMR | Right-hand side of drawer |
| XXML | Left-hand side of drawer |
| XXMRL | Right-hand and left-hand sides of drawer |



Technician Toolbox



DRAWER ACCESSORIES

Drawer accessories customize a drawer's interior to your inventory or tools.

- Partitions and dividers can be easily moved and rearranged
- Change interior configurations as inventory or storage requirements change
- Additional accessories not listed are available

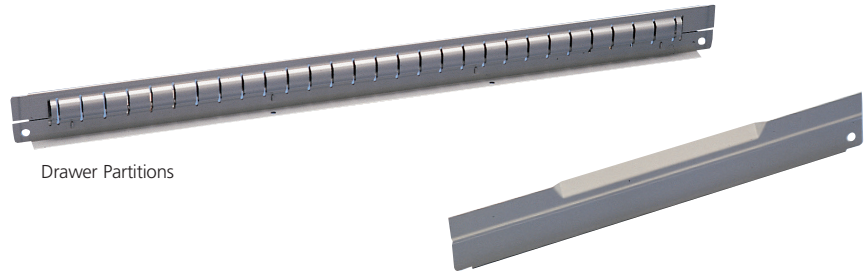

Drawer Partitions

Drawer Dividers

DRAWER PARTITIONS

- Partitions span entire width or depth of a drawer
- Slide into slots on drawer walls and fasten to drawer bottom at prepunched locations
- Use with dividers to customize drawer interiors
- Includes hardware for fastening to drawer bottom

Drawer Partitions

| DRAWER TYPE | # OF SPACES | APPROX. LENGTH | FITS DRAWER | FITS DRAWER | FITS DRAWER | FITS DRAWER |
|-----------------------------------|-------------|------------------|-------------------------------------|-------------------------------------|--------------------------------------|----------------------------------|
| | | | MODELS 20 & 25 1-7/8" (48MM) HT. | MODELS 30 & 35 2-7/8" (73MM) HT. | MODELS 40 & 45 4-1/2" (114MM) HT. | MODELS 50+ 5-1/4" (133MM) HT. |
| Standard/LW/SV | 32 | 25-1/2" (648mm) | P20* | P30* | P40* | P50* |
| Extra-Wide | 51 | 40-1/2" (1029mm) | P2051 | P3051 | P4051 | P5051 |
| Double-Wide | 70 | 55-5/8" (1413mm) | P2070 | P3070 | P4070 | P5070 |
| SL, LW XL & DL (front to back) | 24 | 19" (483mm) | P2024 | P3024 | P4024 | P5024 |

DRAWER DIVIDERS

- Use with partitions to subdivide drawer space

NOTE: Dividers that are 9-1/2" (241mm) long and over are supplied with screws for fastening to drawer bottom.

Standard Drawer Dividers

| # OF SPACES | APPROX. LENGTH | USABLE COMPARTMENT WIDTH | FITS DRAWER | FITS DRAWER | FITS DRAWER | FITS DRAWER |
|-------------|-----------------|--------------------------|-------------------------------------|-------------------------------------|--------------------------------------|----------------------------------|
| | | | MODELS 20 & 25 1-7/8" (48MM) HT. | MODELS 30 & 35 2-7/8" (73MM) HT. | MODELS 40 & 45 4-1/2" (114MM) HT. | MODELS 50+ 5-1/4" (133MM) HT. |
| 2 | 1-1/2" (38mm) | 1-1/8" (29mm) | D2002* | D3002* | — | — |
| 3 | 2-1/4" (57mm) | 1-7/8" (48mm) | D2003* | D3003* | — | — |
| 4 | 3" (76mm) | 2-5/8" (67mm) | D2004* | D3004* | D4004* | D5004* |
| 5 | 3-7/8" (98mm) | 3-1/2" (89mm) | D2005* | D3005* | D4005* | D5005* |
| 6 | 4-5/8" (117mm) | 4-1/4" (108mm) | D2006* | D3006* | D4006* | D5006* |
| 7 | 5-1/2" (140mm) | 5-1/8" (130mm) | D2007* | D3007* | D4007* | D5007* |
| 8 | 6-1/4" (159mm) | 5-7/8" (149mm) | D2008* | D3008* | D4008* | D5008* |
| 9 | 7" (178mm) | 6-5/8" (168mm) | D2009* | D3009* | D4009* | D5009* |
| 10 | 7-7/8" (200mm) | 7-1/2" (190mm) | D2010* | D3010* | D4010* | D5010* |
| 11 | 8-5/8" (219mm) | 8-1/4" (210mm) | D2011* | D3011* | D4011* | D5011* |
| 12 | 9-1/2" (241mm) | 9-1/8" (232mm) | D2012* | D3012* | D4012* | D5012* |
| 13 | 10-1/4" (260mm) | 9-7/8" (251mm) | D2013* | D3013* | D4013* | D5013* |
| 14 | 11" (279mm) | 10-5/8" (270mm) | D2014* | D3014* | D4014* | D5014* |
| 15 | 11-7/8" (302mm) | 11-1/2" (292mm) | D2015* | D3015* | D4015* | D5015* |
| 16** | 12-5/8" (321mm) | 12-1/4" (311mm) | D2016* | D3016* | D4016* | D5016* |
| 17 | 13-1/2" (343mm) | 13-1/8" (333mm) | D2017* | D3017* | D4017* | D5017* |
| 18 | 14-1/4" (362mm) | 13-7/8" (352mm) | D2018* | D3018* | D4018* | D5018* |
| 19 | 15" (381mm) | 14-5/8" (371mm) | D2019* | D3019* | D4019* | D5019* |
| 20 | 15-7/8" (403mm) | 15-1/2" (394mm) | D2020* | D3020* | D4020* | D5020* |
| 21 | 16-5/8" (422mm) | 16-1/4" (413mm) | D2021* | D3021* | D4021* | D5021* |
| 22 | 17-1/2" (445mm) | 17-1/8" (435mm) | D2022* | D3022* | D4022* | D5022* |
| 23** | 18" (457mm) | 17-7/8" (454mm) | D2023* | D3023* | D4023* | D5023* |
| 24** | 19" (483mm) | 18-5/8" (473mm) | D2024* | D3024* | D4024* | D5024* |
| 25 | 19-7/8" (505mm) | 19-1/2" (495mm) | D2025* | D3025* | D4025* | D5025* |
| 26 | 20-5/8" (524mm) | 20-1/4" (514mm) | D2026* | D3026* | D4026* | D5026* |
| 27 | 21-1/2" (546mm) | 21-1/8" (537mm) | D2027* | D3027* | D4027* | D5027* |
| 28 | 22-1/4" (565mm) | 21-7/8" (556mm) | D2028* | D3028* | D4028* | D5028* |
| 29 | 23" (584mm) | 22-5/8" (575mm) | D2029* | D3029* | D4029* | D5029* |
| 32*** | 25-3/8" (645mm) | 25-1/8" (638mm) | DS2032 | DS3032 | DS4032 | DS5032 |

*Vidmar® Quick Ship products **Also available in straight dividers ***Only available in straight dividers



CABINETS: Drawer Features & Accessories

PLASTIC BINS AND DIVIDERS

- Ideal for storing smaller items
- Bins can quickly be removed for easy handling, issuing, and counting
- Bins can be made smaller with dividers

In any drawer using bins, it is recommended that a single side-to-side partition be installed.

Snap-on plastic label holders and paper labels must be ordered separately.



Plastic Bins

| MODEL # | DIMENSIONS (H X W X D) | MAX DIVIDER COUNT | USED WITH DRAWER MODEL # | MAX # OF BINS PER DRAWER |
|----------|--|-------------------|--------------------------|--------------------------|
| BN2544* | 2-1/8" x 3" x 3" (54mm x 76mm x 76mm) | 1 | 20 or 25 | 64 |
| BN2548* | 2-1/8" x 3" x 6-1/8" (54mm x 76mm x 156mm) | 1 | 20 or 25 | 32 |
| BN2588* | 2-1/8" x 6-1/8" x 6-1/8" (54mm x 156mm x 156mm) | 1 | 20 or 25 | 16 |
| BN25816* | 2-1/8" x 6-1/8" x 12-1/4" (54mm x 156mm x 311mm) | 3 | 20 or 25 | 8 |
| BN3548* | 3-3/4" x 3" x 6-1/8" (95mm x 76mm x 156mm) | 1 | 30 or 35 | 32 |
| BN3588* | 3-3/4" x 6-1/8" x 6-1/8" (95mm x 156mm x 156mm) | 1 | 30 or 35 | 16 |
| BN35816* | 3-3/4" x 6-1/8" x 12" (95mm x 156mm x 305mm) | 3 | 30 or 35 | 8 |

*Vidmar® Quick Ship

BIN LABEL HOLDERS

Model # BLH02

- Includes paper labels
- Dimensions (H x W) 2-1/8" x 5/8" (54mm x 16mm)

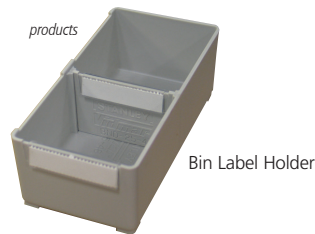

Bin Label Holder

Bin Dividers

| MODEL # | USED WITH BIN MODEL # |
|---------|-----------------------|
| BND254* | BN2544 or BN2548 |
| BND258* | BN2588 or BN25816 |
| BND354* | BN3548 |
| BND358* | BN3588 or BN35816 |

PLASTIC QUARTER TRAYS

Model # QT20

- Quarter trays take up one-quarter of a standard drawer
- 20 Compartments, 1-1/4 x 2-1/4 x 2-7/8" (32 x 57 x 73mm)
- Both partitions and dividers should be used when using less than a full drawer of quarter trays

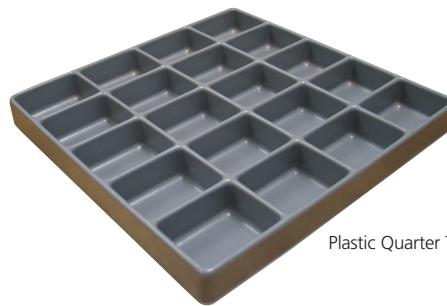

Plastic Quarter Tray

LABEL HOLDERS

- Provides instant identification of drawer compartment contents
- Label holders snap directly onto the divider
- Paper labels and vinyl protective shields included



Label Holders

| MODEL # | FITS DIVIDER MODEL # ENDING IN | LENGTH |
|---------|--------------------------------|-----------------|
| LH01 | Universal | 1-3/16" (33mm) |
| LH04 | 04 and larger | 2-5/8" (67mm) |
| LH06 | 06 and larger | 4-3/16" (106mm) |

Vidmar® Quick Ship products

PLASTIC GROOVE TRAYS AND DIVIDERS

- Available in three sizes
- Store and separate elongated items
- Trays take up one-fifth of a standard drawer
- Can be divided into compartments with groove tray label holders

Plastic Groove Trays and Dividers

| MODEL # | DRAWER MODEL | # OF GROOVES | GROOVE OPENING | TRAY WIDTH | QTY. PER DRAWER | LABEL HOLDER* |
|---------|--------------|--------------|----------------|------------|-----------------|---------------|
| PGT22 | 20 | 5 | 7/8" (22mm) | 5" (127mm) | 5 | GTL22 |
| PGT37 | 20 | 3 | 1-1/2" (38mm) | 5" (127mm) | 5 | GTL37 |
| PGT58 | 25 | 2 | 2-1/4" (57mm) | 5" (127mm) | 5 | GTL58 |

*Purchased separately

GROOVE TRAY DIVIDER LABEL HOLDERS

- Supplied with paper labels and vinyl protective shield



Plastic Groove Tray



Drill Bit Tray

Groove Tray Divider Label Holders

| MODEL # | USED WITH GROOVE TRAY MODEL |
|---------|-----------------------------|
| GTL22 | PGT22 |
| GTL37 | PGT37 |
| GTL58 | PGT58 |

HANGING FILE FRAME

Models PS70, SVPS70, LWPS70, XWPS70

- Designed to be used with model 70 drawer or larger
- One filing kit fills a standard drawer
- Holds two rows of hanging files
- Includes two letter-size steel frames and a file divider

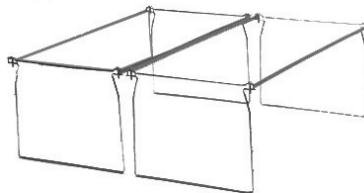

Hanging File Frame

CABINETS: Drawer Features & Accessories

DRAWER LINERS

Use prefix to note drawer size:
Standard (no prefix), Double-Wide (DW), Shallow Depth (LW), Small Version (SV), Extra-Wide (XW), Extra-Wide Shallow Depth (XL), Double-Wide Shallow Depth (DL), Small Version Shallow Depth (SL).
(example: DWML10)

- Helps protect delicate tools and instruments
- Pegboard and fiberboard required for use with drawer bottom posts

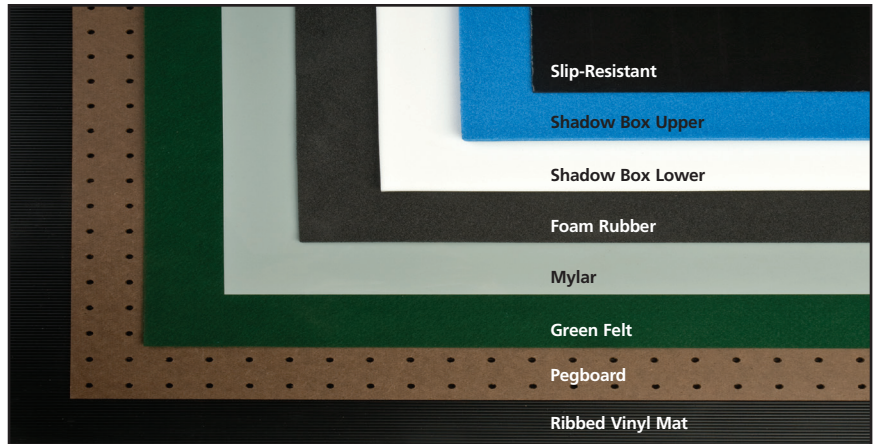

Drawer Bottom Liners

| CABINET STYLE | FIBERBOARD (3/8"/10MM) | FOAM RUBBER | GREEN FELT | MYLAR | PEGBOARD | RIBBED VINYL MAT | SHADOW BOX | SLIP-RESISTANT |
|-----------------------------|------------------------|-------------|------------|--------|----------|------------------|-------------|----------------|
| Standard Cabinets (STD) | FB06 | FR01 | GF01 | ML10 | PB02 | IA-ST-001-25 | SBDIBL/WH | NS01 |
| Shallow Depth Cabinets (LW) | LWFB06 | LWFR01 | LWGF01 | LWML10 | LWPB02 | IA-LW-001-25 | LWSBDIBL/WH | LWNS01 |
| Small Version Cabinets (SV) | SVFB06 | SVFR01 | SVGF01 | SVML10 | SVPB02 | IA-SV-001-25 | SVSBDIBL/WH | SVNS01 |
| Small Version Shallow | | | | | | | | |
| Depth Cabinets (SL) | SLFB06 | SLFR01 | SLGF01 | SLML10 | SLPB02 | IA-SL-001-25 | SLSBDIBL/WH | SLNS01 |
| Extra-Wide Cabinets (XW) | XWFB06 | XWFR01 | XWGF01 | XWML10 | XWPB02 | IA-XW-001-25 | XWSBDIBL/WH | XWNS01 |
| Extra-Wide Shallow | | | | | | | | |
| Depth Cabinets (XL) | XLFB06 | XLFR01 | XLGF01 | XLML10 | XWPB02 | — | XLSBDIBL/WH | XLNS01 |
| Double-Wide Cabinets (DW) | DWFB06 | DWFR01 | DWGF01 | DWML10 | DWPB02 | IA-DW-001-25 | DWSBDIBL/WH | DWNS01 |
| Double-Wide Shallow | | | | | | | | |
| Depth Cabinets (DL) | DLFB06 | DLFR01 | DLGF01 | DLML10 | DLPB02 | IA-DL-001-25 | DLSBDIBL/WH | DLNS01 |



Cabinet drawer accessories perfect for all applications

ROLL-OUT SHELVES

Operating on the same carriage system as standard drawers, roll-out shelves are designed to store heavy, bulky, or awkward items, up to 400 lbs. The reinforced shelf allows items to be slid off the side rather than lifted. Roll-out shelves use the same model numbers as cabinet drawers, which range from 20 to 90. Like the drawers, each model number represents a different usable height. Roll-out shelves can be used alone or in combination with drawers.

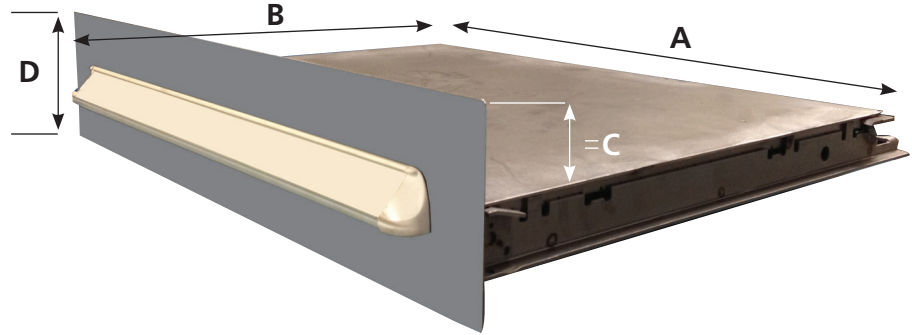

Pictured: STD0340 with RS20 in Bright Blue (S22447)

Roll-Out Shelf Type

| | "A" SIDE TO SIDE | "B" FRONT TO BACK |
|----------------------------------|---------------------|----------------------|
| Standard - STD | 26-1/8" | 26" |
| Shallow Depth - LW | 26-1/4" | 19-9/16" |
| Small Version - SV | 19-1/8" | 25-9/16" |
| Small Version Shallow Depth - SL | 19-1/8" | 19-9/16" |
| Extra-Wide - XW | 41-1/4" | 26" |
| Extra-Wide Shallow Depth - XL | 41-1/4" | 19-9/16" |
| Double-Wide - DW | 56-3/8" | 26" |
| Double-Wide Shallow Depth - DL | 56-3/8" | 19-9/16" |



Pictured: STD0340 with RS20 in Dark Blue (S22578)

Roll-Out Shelf Model

| STANDARD (STD) | SHALLOW DEPTH (LW) | SMALL VERSION (SV) | SMALL VERSION SHALLOW DEPTH (SL) | EXTRA-WIDE (XW) | EXTRA-WIDE SHALLOW DEPTH (XL) | DOUBLE-WIDE (DW) | DOUBLE-WIDE SHALLOW DEPTH (DL) | CLEAR HEIGHT "C" |
|----------------|--------------------|--------------------|----------------------------------|-----------------|-------------------------------|------------------|--------------------------------|------------------|
| RS20 | LWRS20 | SVRS20 | SLRS20 | XWRS20 | XLRS20 | DWRS20 | DLRS20 | 1/4" |
| RS25 | LWRS25 | SVRS25 | SLRS25 | XWRS25 | XLRS25 | DWRS25 | DLRS25 | 1" |
| RS30 | LWRS30 | SVRS30 | SLRS30 | XWRS30 | XLRS30 | DWRS30 | DLRS30 | 1-3/4" |
| RS35 | LWRS35 | SVRS35 | SLRS35 | XWRS35 | XLRS35 | DWRS35 | DLRS35 | 2-5/8" |
| RS40 | LWRS40 | SVRS40 | SLRS40 | XWRS40 | XLRS40 | DWRS40 | DLRS40 | 3-3/8" |
| RS45 | LWRS45 | SVRS45 | SLRS45 | XWRS45 | XLRS45 | DWRS45 | DLRS45 | 4-1/8" |
| RS50 | LWRS50 | SVRS50 | SLRS50 | XWRS50 | XLRS50 | DWRS50 | DLRS50 | 4-7/8" |
| RS55 | LWRS55 | SVRS55 | SLRS55 | XWRS55 | XLRS55 | DWRS55 | DLRS55 | 5-3/4" |
| RS60 | LWRS60 | SVRS60 | SLRS60 | XWRS60 | XLRS60 | DWRS60 | DLRS60 | 6-1/2" |
| RS65 | LWRS65 | SVRS65 | SLRS65 | XWRS65 | XLRS65 | DWRS65 | DLRS65 | 7-1/4" |
| RS70 | LWRS70 | SVRS70 | SLRS70 | XWRS70 | XLRS70 | DWRS70 | DLRS70 | 8-1/8" |
| RS75 | LWRS75 | SVRS75 | SLRS75 | XWRS75 | XLRS75 | DWRS75 | DLRS75 | 8-7/8" |
| RS80 | LWRS80 | SVRS80 | SLRS80 | XWRS80 | XLRS80 | DWRS80 | DLRS80 | 9-5/8" |
| RS85 | LWRS85 | SVRS85 | SLRS85 | XWRS85 | XLRS85 | DWRS85 | DLRS85 | 10-1/2" |
| RS90 | LWRS90 | SVRS90 | SLRS90 | XWRS90 | XLRS90 | DWRS90 | DLRS90 | 11-1/4" |

CABINETS: Roll-Out Shelf/Roll-Out Tray

ROLL-OUT TRAY

Ideal for the storage of heavy, bulky items, the Vidmar® Roll-Out Tray Cabinet provides full access to all stored items at once, plus the ability to fully extend your trays. Experience a new level of convenience combined with everything you expect from Vidmar!



Flanged Door Hinge



Lock-in Latch



Roll-out Tray Cabinet

SHELF CABINETS

Ideal for bulk material storage (gloves, cloths, rags, boxes, etc.), Vidmar® shelf cabinets are available with or without doors and are equipped with a magnetic catch (locks are also available). Shelf cabinets are constructed to the same dimensions and design as Vidmar® standard drawer storage cabinets, allowing the seamless integration of shelf and drawer cabinets. Shelf cabinets can be converted to drawer cabinets at any time.



Preconfigured Shelf Cabinets Model #

Housing Height

| | |
|------|--------------|
| 0135 | 27" (686mm) |
| 0155 | 30" (762mm) |
| 0175 | 33" (838mm) |
| 0200 | 37" (940mm) |
| 0245 | 44" (1118mm) |
| 0340 | 59" (1499mm) |

| STANDARD (STD) | SHALLOW DEPTH (LW) | SMALL VERSION (SV) | SMALL VERSION SHALLOW DEPTH (SL) | EXTRA-WIDE (XW) | EXTRA-WIDE SHALLOW DEPTH (XL) | DOUBLE-WIDE (DW) | DOUBLE-WIDE SHALLOW DEPTH (DL) |
|----------------|--------------------|--------------------|----------------------------------|-----------------|-------------------------------|------------------|--------------------------------|
| SC135X1A | LWS1351A | SVS1351A | SLS1351A | XWS1351A | XLS1351A | DWS1351A | DLS1351A |
| SC155X1A | LWS1551A | SVS1551A | SLS1551A | XWS1551A | XLS1551A | DWS1551A | DLS1551A |
| SC175X1A | LWS1751A | SVS1751A | SLS1751A | XWS1751A | XLS1751A | DWS1751A | DLS1751A |
| SC200X1A | LWS2001A | SVS2001A | SLS2001A | XWS2001A | XLS2001A | DWS2001A | DLS2001A |
| SC2451XA | LWS2451A | SVS2451A | SLS2451A | XWS2451A | XLS2451A | DWS2451A | DLS2451A |
| SC340X2A* | LWS3402A* | SVS3402A* | SLS3402A* | XWS3402A* | XLS3402A* | DWS3402A* | DLS3402A* |

*All include two 400 lb. capacity shelves



Preconfigured Shelf Door Cabinets Model #

| STANDARD (STD)** | SHALLOW DEPTH (LW)** | SMALL VERSION (SV)** | SMALL VERSION SHALLOW DEPTH (SL)** | EXTRA-WIDE (XW)** | EXTRA-WIDE SHALLOW DEPTH (XL)** | DOUBLE-WIDE (DW)** | DOUBLE-WIDE SHALLOW DEPTH (DL)** |
|------------------|----------------------|----------------------|------------------------------------|-------------------|---------------------------------|--------------------|----------------------------------|
| SD135R/L1AL | LWD13R/L1AL | SVD13R/L1AL | SLD13R/L1AL | XWD1351AL | XLD1351AL | DWD1351AL | DLD1351AL |
| SD155R/L1AL | LWD15R/L1AL | SVD15R/L1AL | SLD15R/L1AL | XWD1551AL | XLD1551AL | DWD1551AL | DLD1551AL |
| SD175R/L1AL | LWD17R/L1AL | SVD17R/L1AL | SLD17R/L1AL | XWD1751AL | XLD1751AL | DWD1751AL | DLD1751AL |
| SD200R/L1AL | LWD20R/L1AL | SVD20R/L1AL | SLD20R/L1AL | XWD2001AL | XLD2001AL | DWD2001AL | DLD2001AL |
| SD245R/L1AL | LWD24R/L1AL | SVD24R/L1AL | SLD24R/L1AL | XWD2451AL | XLD2451AL | DWD2451AL | DLD2451AL |
| SD340R/L2AL* | LWD34R/L2AL* | SVD34R/L2AL* | SLD34R/L2AL* | XWD3402AL* | XLD3402AL* | DWD3402AL* | DLD3402AL* |

***R/L Please specify right- or left-hand hinge **Double doors *All include two 400 lb. capacity shelves



Shelf/Shelf Door Cabinet Model #

| | STANDARD (STD) | SHALLOW DEPTH (LW) | SMALL VERSION (SV) | SMALL VERSION SHALLOW DEPTH (SL) | EXTRA-WIDE (XW) | EXTRA-WIDE SHALLOW DEPTH (XL) | DOUBLE-WIDE (DW) | DOUBLE-WIDE SHALLOW DEPTH (DL) |
|------------------------|----------------|--------------------|--------------------|----------------------------------|-----------------|-------------------------------|------------------|--------------------------------|
| Housing | xxxx | LWxxxx | SVxxxx | SLxxxx | XWxxxx | XLxxxx | DWxxxx | DLxxxx |
| 400 lb. Shelf | CS40 | LWCS40 | SVCS40 | SLCS40 | XWCS40 | XLCS40 | DWCS40 | DLCS40 |
| 800 lb. Shelf | CS80 | LWCS80 | SVCS80 | SLCS80 | XWCS80 | XLCS80 | DWCS80 | DLCS80 |
| Bottom Pan | BP80 | LWBP80 | SVBP80 | SLBP80 | XWBP80 | XLBP80 | DWBP80 | DLBP80 |
| Door | SDDxxx** | SDDxxx** | SVSDDxxx** | SVSDDxxx** | XWSDDxxx | XWSDDxxx | DWSDDxxx | DWSDDxxx |
| 6" Bottom Pan Dividers | SDV06B | - | SDV06B | - | SDV06B | - | SDV06B | - |

** Please specify right- or left-hand hinge For xxx substitute with housing Model #



CABINETS: Shelf/Shelf Door Cabinets

SHELF DOOR LOCKS

- For security, shelf door cabinet locks are available



Doors in Off-White (S22570)

Shelf Door Locks

| MODEL # | USED WITH CABINETS |
|---------|------------------------|
| SDL3401 | 340 Shelf Door Cabinet |
| SDL2451 | 245 Shelf Door Cabinet |
| SDL2001 | 200 Shelf Door Cabinet |
| SDL1751 | 175 Shelf Door Cabinet |
| SDL1551 | 155 Shelf Door Cabinet |
| SDL1351 | 135 Shelf Door Cabinet |

MESH DOORS

- Vidmar® shelf cabinets can also be configured with mesh doors, providing visibility into the cabinet while keeping stored items out of the reach of unauthorized users
- Mesh doors also allow airflow to help evaporate moisture or provide ventilation to heat-generating items



Pictured: STD0155 in Red (S50054) with EMD155RH



Pictured: XW0155 in Hunter Green (S50091) with XWEMD155RH

DOOR OVER DRAWER

- Feature allows a Vidmar drawer or roll-out shelf cabinet to have a door over the drawers
- Is used for added security



SHELF LINERS

- Helps protect delicate tools and instruments
- Pegboard and fiberboard required for use with drawer bottom posts

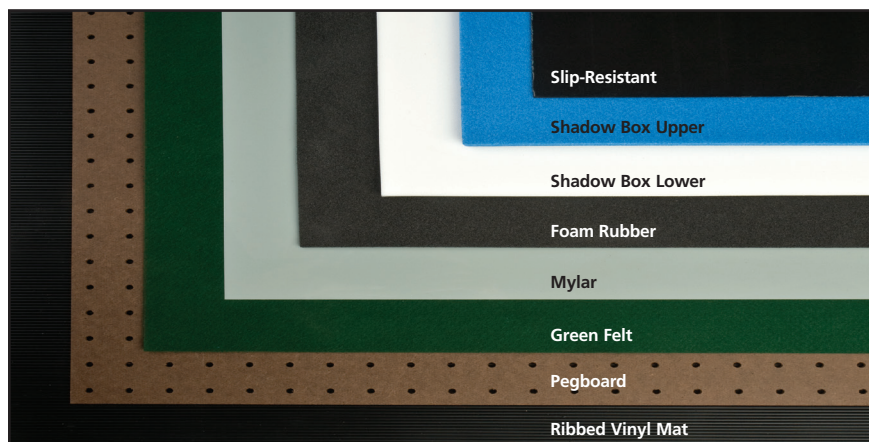

Shelf Liners

OVERHEAD CABINETS

Ideal for existing cabinet storage systems or new cabinet system installations, Vidmar® overhead storage (OS) cabinets provide additional heavy-duty storage space above cabinets. Overhead cabinets are manufactured to the same dimensions as the rest of Vidmar's cabinets, allowing for seamless modular integration into any Vidmar® cabinet solution.



Housing Height:

- 0110** 20.75" (527mm)
- 0135** 24.68" (627mm)
- 0155** 27.83" (707mm)
- 0175** 30.98" (787mm)
- 0200** 34.91" (887mm)
- 0245** 42.00" (1,067mm)



Preconfigured Overhead Shelf Cabinets Model # (includes 1 - 400lb. shelf)

| STANDARD. (STD) | SHALLOW DEPTH (LW) | SMALL VERSION (SV) | EXTRA-WIDE (XW) | EXTRA-WIDE SHALLOW DEPTH (XL) | DOUBLE-WIDE (DW) |
|--------------------|--------------------------|--------------------------|--------------------|-------------------------------------|---------------------|
| OS110X1A | LWO1101A | SVO1101A | XWO1101A | XLO1101A | DWO1101A |
| OS135X1A | LWO1351A | SVO1351A | XWO1351A | XLO1351A | DWO1351A |
| OS155X1A | LWO1551A | SVO1551A | XWO1551A | XLO1551A | DWO1551A |
| OS175X1A | LWO1751A | SVO1751A | XWO1751A | XLO1751A | DWO1751A |
| OS200X1A | LWO2001A | SVO2001A | XWO2001A | XLO2001A | DWO2001A |
| OS2451XA | LWO2451A | SVO2451A | XWO2451A | XLO2451A | DWO2451A |

Overhead Shelf Cabinets Model

| | STANDARD. (STD) | SHALLOW DEPTH (LW) | SMALL VERSION (SV) | EXTRA-WIDE (XW) | EXTRA-WIDE SHALLOW DEPTH (XL) | DOUBLE-WIDE (DW) |
|------------------------|--------------------|-----------------------|-----------------------|--------------------|----------------------------------|---------------------|
| OS Cabinet | OSXXXX | LWOSXXXX | SVOSXXXX | XWOSXXXX | XLOSXXXX | DWOSXXXX |
| 400 lb. Shelf | CS40 | LWCS40 | SVCS40 | XWCS40 | XLCS40 | DWDCS40 |
| Door | SDDXXXX** | LWSDXXXX** | SDDXXXX** | XWSDXXXX | XWSDXXXX | DWSDXXXX |
| 9" Shelf Dividers | SDV09 | LWSDV09 | SDV09 | SDV09 | LWSDV09 | SDV09 |
| 12" Shelf Dividers | SDV12 | LWSDV12 | SDV12 | SDV12 | LWSDV12 | SDV12 |
| 6" Bottom Pan Dividers | SDV06B | - | SDV06B | SDV06B | - | SDV06B |

**Please specify right- or left-hand hinge

CABINETS: Overhead Cabinets

CABINETS AND DOORS

For cabinets and doors, substitute cabinet height number for "XXX" in model numbers [ex.: OS245 is a 42" (1067mm cabinet)].

SHELVES

For shelves, choose either 400 lb. (181kg) or 800 lb. (362kg) capacity; replace "40" with "80" in shelf model number for 800 lb. capacity shelf.

SHELF DOOR LOCKS

For doors with locks, add "L" to end of Model #.

- Secure shelf door cabinets

SHELF DIVIDERS

For shelf dividers, order either 9" (229mm), Model # SDV09, or 12" (305mm) Model # SDV12. Same size versions are available for shallow depth cabinets: 9", Model # LWSDV09 and 12", Model # LWSDV12.

- Not for use in supporting other stacked cabinets in mezzanine or high-rise applications



Pictured: DWPT0175 with STD0340 Drawer Units in Hunter Green (550091) Housings and Off-White (S22570) Drawers and Shelves



Shelf Door Locks



Doors in Off-White (S22570)

| MODEL # | DESCRIPTION |
|---------|--------------------------|
| SDL1351 | 0135 Shelf Door Cabinets |
| SDL1551 | 0155 Shelf Door Cabinets |
| SDL1751 | 0175 Shelf Door Cabinets |
| SDL2001 | 0200 Shelf Door Cabinets |
| SDL2451 | 0245 Shelf Door Cabinets |
| SDL3401 | 0340 Shelf Door Cabinets |



Shelves in Off-White (S22570)



Shelf Dividers in Off-White (S22570)

MOBILE CABINETS

Wherever you need to work, Vidmar® mobile storage cabinets are in on the action. Heavy-duty mobile casters make our mobile cabinets easy to move, allowing you to position them exactly where you need them. Vidmar offers preconfigured mobile storage cabinets, or you can custom-build your mobile cabinet in any size and configuration you choose. All Vidmar® mobile storage cabinets require lock-in/lock-out latches or single-drawer release.



RP1441AL - Four Drawers

Table Height - 35"
30" (762mm) Standard Width
27-3/4" (705mm) Standard Depth
Shipping Weight: 250 lbs. (136kg)

| DRAWERS | DRAWER MODEL # | USABLE HEIGHT |
|---------|----------------|-----------------|
| 1 | 20 | 2-1/4" (57mm) |
| 1 | 30 | 3-7/8" (98mm) |
| 1 | 35 | 4-5/8" (117mm) |
| 1 | 70 | 10-1/8" (257mm) |



RP1200AL - Five Drawers

Bench Height - 38"
30" (762mm) Standard Width
21-3/8" (543mm) Shallow Depth
Shipping Weight: 208 lbs. (135kg)

| DRAWERS | DRAWER MODEL # | USABLE HEIGHT |
|---------|----------------|----------------|
| 1 | 20 | 2-1/4" (57mm) |
| 1 | 25 | 3" (76mm) |
| 1 | 30 | 3-7/8" (98mm) |
| 1 | 40 | 5-3/8" (137mm) |
| 1 | 60 | 8-1/2" (216mm) |



RP1978AL - Eight Drawers

Stand-Up Height - 42"
45" (1143mm) Extra-Wide Width
21-3/8" (543mm) Shallow Depth
Shipping Weight: 401 lbs. (226kg)

| DRAWERS | DRAWER MODEL # | USABLE HEIGHT |
|---------|----------------|----------------|
| 1 | XL20 | 2-1/4" (57mm) |
| 4 | XL20 | 2-1/4" (57mm) |
| 2 | XL30 | 3-7/8" (98mm) |
| 1 | XL40 | 5-3/8" (137mm) |



RP1979AL - Eight Drawers

Stand-Up Height - 42"
30" (762mm) Standard Width
21-3/8" (543mm) Shallow Depth
Shipping Weight: 345 lbs. (215kg)

| DRAWERS | DRAWER MODEL # | USABLE HEIGHT |
|---------|----------------|----------------|
| 1 | LW20 | 2-1/4" (57mm) |
| 4 | LW20 | 2-1/4" (57mm) |
| 2 | LW30 | 3-7/8" (98mm) |
| 1 | LW40 | 5-3/8" (137mm) |

CABINETS: Mobile Cabinets

MOBILE CABINET ACCESSORIES

Mobile caster kit should be specified when ordering mobile cabinets. Options include 2" hard rubber wheels, 5" hard rubber wheels, and 6" polyurethane read locked to polyolefin core. For a full caster kit option chart, visit our Interactive Product Catalog at StanleyVidmar.com.

Additional mobile cabinet accessories include MR latches, cabinet top trays (ideal for keeping small or rolling parts safe and close at hand), tow bars, and battens (used to keep items securely on shelves while being transported or stored shipboard).

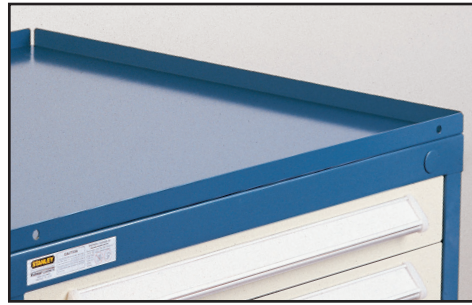

Cabinet Top Tray

Cabinet Top Trays

| MODEL # | USED WITH CABINETS |
|---------|-----------------------------|
| CTTST | Standard Cabinets |
| CTTSV | Small Version Cabinets |
| CTTLW | Shallow Depth Cabinets |
| CTTXW | Extra-Wide Cabinets |
| CTTDW | Double-Wide Cabinets |
| CTTXL | Extra-Wide Shallow Depth |
| CTTDL | Double-Wide Shallow Depth |
| CTTSL | Small Version Shallow Depth |

CABINET TOP TRAY

- Cabinet top trays attach through knockouts, available on all cabinets
- 1" (25mm) height
- Ideal for keeping small or rolling parts and tools safe and close at hand

CABINET TOP TRAY HANDLE

- Cabinet top tray handle is an integrated top tray and handle



Cabinet Top Tray Handle

Cabinet Top Tray Handle

| MODEL # | USED WITH CABINETS |
|--------------|-----------------------------|
| CTTST Handle | Standard Cabinets |
| CTTSV Handle | Small Version Cabinets |
| CTTLW Handle | Shallow Depth Cabinets |
| CTTXW Handle | Extra-Wide Cabinets |
| CTTDW Handle | Double-Wide Cabinets |
| CTTXL Handle | Extra-Wide Shallow Depth |
| CTTDL Handle | Double-Wide Shallow Depth |
| CTTSL Handle | Small Version Shallow Depth |

TOW BAR

Model # UTB-22 (Also order appropriate adapter kit)

Adapter kits:

Model # UTBAK-22, for all housings except shallow depth

Model # UTBAK-22-LW for shallow depth housings

- Tow bars are used to tow cabinets in mobile applications
- Attached to base of all housing styles with adapter kit
- Use tow bars only on cabinets with lock-in/lock-out latches
- Use only on cabinet heights of 175 or smaller



Tow Bar

Tow Bars - Additional Weld Feature

| MODEL # | USED WITH CABINETS |
|---------|-------------------------------|
| AWFST | Standard Cabinets, XW, and DW |
| AWFLW | Shallow Depth Cabinets |
| AWFSV | Extra-Wide Cabinets |
| AWFXL | Shallow Depth, Extra-Wide |
| AWFDW | Double-Wide |

Additional Weld Feature

See chart for model numbers

Additional welds are added for towing applications to maintain cabinet strength and performance

CASTERS WITH CHANNEL OPTIONS

- Subject to change visit STANLEYVidmar.com for current images



| USED WITH HOUSING NO FEET FEATURE | 2" HARD RUBBER WHEEL (ADDS 3" TO CABINET) | | 5" HARD RUBBER WHEEL (ADDS 7-1/4" TO CABINET W/O FEET) | | 6" POLYURETHANE TREAD LOCKED TO POLYOLEFIN CORE (ADDS 8-1/4" TO CABINET) | | WITHOUT FEET HANDLES (ORDERED SEPARATELY) |
|--------------------------------------|--|----------------------------|---|-----------------------------|---|-----------------------------|--|
| | WT. CAP. 200 LB./WHL (90KG) | WHEEL DIA. 2" (50MM) | WT. CAP. 350 LB./WHL (158KG) | WHEEL DIA. 5" (127MM) | WT. CAP. 900 LB./WHL (408KG) | WHEEL DIA. 6" (152MM) | |
| One Cabinet Mobile Base | 4 Swivel Casters With Channel | | 2 Rigid 2 Swivel Casters With Channel | | 2 Rigid 2 Swivel Casters With Channel | | |
| Standard | 1MB2HRSTS | | 1MB5HRST | | 1MB6PPST | | MHST |
| Shallow Depth | 1MB2HRLWS | | 1MB5HRLW | | 1MB6PPLW | | MHLW |
| Small Version | 1MB2HRSVS | | 1MB5HRSV | | 1MB6PPSV | | MHSV |
| Extra-Wide | 1MB2HRXWS | | 1MB5HRXW | | 1MB6PPXW | | MHST |
| Extra-Wide Shallow Depth | 1MB2HRXLS | | 1MB5HRXL | | 1MB6PPXL | | MHLW |
| Double-Wide | 1MB2HRDWS | | 1MB5HRDW | | 1MB6PPDW | | MHST |
| Double-Wide Shallow Depth | N/A | | 1MB5HRDL | | 1MB6PPDL | | MHLW |
| Small Version Shallow Depth | 1MB2HRSL | | 1MB5HRSL | | 1MB6PPSL | | MHLW |
| Two Cabinet Mobile Base | 6 Swivel Casters With Channel | | 2 Rigid 2 Swivel Casters With Channel | | 2 Rigid 2 Swivel Casters With Channel | | |
| Standard | N/A | | 2MB5HRST | | 2MB6PPST | | MHST |
| Shallow Depth | N/A | | N/A | | 2MB6PPLW | | MHLW |
| Small Version | N/A | | 2MB5HRSV | | 2MB6PPSV | | MHSV |
| Two Cabinet Mobile Base | 4 Swivel Casters With Channel | | | | | | |
| Standard | 2MB2HRSTS | | 2MB5HRSTS | | 2MB6PPSTS | | MHST |
| Shallow Depth | 2MB2HRLWS | | N/A | | 2MB6PPLWS | | MHLW |
| Extra-Wide | N/A | | 2MB2HRSVS | | 2MB6PPXWS | | MHST |
| Three Cabinet Mobile Base | | | 2 Rigid 4 Swivel Casters With Channel | | 2 Rigid 4 Swivel Casters With Channel | | |
| Standard | N/A | | 3MB5HRST | | 3MB6PPST | | MHST |
| Small Version | N/A | | N/A | | 3MB6PPSV | | MHSV |

CABINETS: Mobile Cabinets

UTILITY CARTS

A lightweight, highly mobile storage option, Vidmar® utility carts are a great way to keep tools at hand as you move from task to task. Built with the same Vidmar toughness as the rest of our storage cabinet systems, Vidmar® utility carts are available with your choice of one or two drawers.

- Lightweight, heavy-duty, easy-to-move utility work cart
- 16,910 total cubic inches of storage space. Overall storage capacity 600 lbs.
- Holds up to 150 lbs. per drawer
- Dimensions:
Width (top and bottom) 30"
Depth (top) 21.38", (bottom) 30"

Overall height (with casters) 37"
Weight (empty) 163 lbs.



Utility Carts

| MODEL # | DRAWER MODEL# | SHIPPING WEIGHT |
|---------|---------------|-----------------|
| RP5000A | LW40 | 215 lbs. |
| RP5001A | 2-LW20 | 240 lbs. |

VERTICAL DISPLAY CABINETS

Designed to keep tools visible and identifiable from a distance, Vidmar® vertical display cabinets store tools on a pegboard behind locking Plexiglas® bypass doors. Vertical display cabinets can be installed on top of most Vidmar® drawer storage cabinets.

Vertical Display

| MODEL # | HEIGHT | LENGTH | WIDTH |
|---------|-------------|----------------|--------------|
| VDC30 | 30" (762mm) | 21" (543.05mm) | 30" (762mm) |
| VDC60 | 30" (762mm) | 21" (543.05mm) | 60" (1524mm) |



INDUSTRIAL WORKCENTERS

The new Vidmar® industrial workcenter product line offers the quality and versatility of modular drawer storage. With the redesigned workcenter units, the same organization and storage efficiencies have arrived at the technician's workspace.

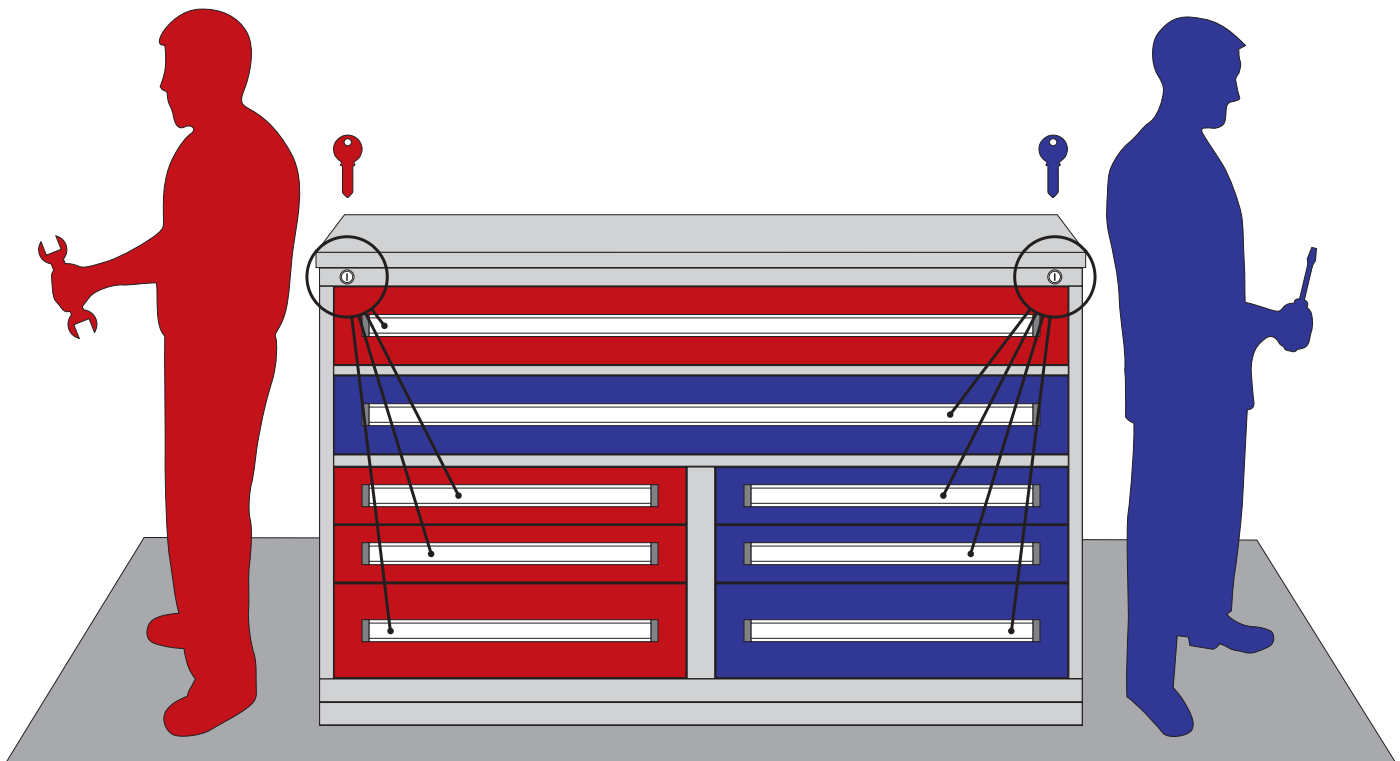

The new Vidmar® industrial workcenter enables two workers to share the same cabinet yet maintain separate lockable drawers.

CABINETS: Workcenters/Toolboxes

CABINETS



WELD CELL SUPPORT



TOOL & DIE MANAGEMENT



METAL FABRICATION



CNC PROTOTYPING & MACHINING



HEAVY TRUCK/AUTOMOTIVE REPAIR



ROBOTIC TESTING CELLS



GENERAL MANUFACTURING



INDUSTRIAL ELECTRICIAN

PRECONFIGURED INDUSTRIAL WORKCENTERS

- Drawer capacity and drawer carriage system capacity 400 lbs.
- Heavy-duty casters, spring-loaded casters available, 900 lbs. per caster
- Mobile handles match cabinet color
- Doors and drawers keyed alike
- Black end caps standard



RP1954AL - Five Drawers

Workcenter Height - 42" (includes work surface)
45" Extra-Wide Width
27-3/4" Standard Depth

| DRAWERS | DRAWER MODEL # | USABLE HEIGHT | COMPARTMENTS | LOADING DIAGRAM # |
|---------|----------------|----------------|--------------|-------------------|
| 1 | XW30BKFW | 3-7/8" (98mm) | 1 | - |
| 1 | SV25BK | 3" (76mm) | 1 | - |
| 2 | SV40BK | 5-3/8" (173mm) | 1 | - |
| 1 | SV60BK | 8-1/2" (216mm) | 1 | - |
| 1 | SVCS40 | Shelf | 0 | - |

RP1952AL - Five Drawers

Workcenter Height - 42" (includes work surface)
60" Double-Wide Width
27-3/4" Standard Depth

| DRAWERS | DRAWER MODEL # | USABLE HEIGHT | COMPARTMENTS | LOADING DIAGRAM # |
|---------|----------------|----------------|--------------|-------------------|
| 1 | DW30BKFW | 3-7/8" (98mm) | 1 | - |
| 1 | 25BK | 3" (76mm) | 1 | - |
| 2 | 40BK | 5-3/8" (173mm) | 1 | - |
| 1 | 60BK | 8-1/2" (216mm) | 1 | - |
| 1 | CS40 | Shelf | 0 | - |

CABINETS: Workcenters/Toolboxes

PRECONFIGURED INDUSTRIAL WORKCENTERS

Dimensions:

- Cabinet widths: 45" and 60" wide
- Single drawer usable space;
45" Model: 40-1/4" x 25-1/8"
- 60" model: 55-3/8" x 25-1/8"
- Drawer bank usable space;
45" Model: 17-7/8" x 25-1/8"
- 60" Model: 25-1/8" x 25-1/8"
- Cabinet heights: 31" (0175) and 35" (0200)
- Drawer heights: standard Vidmar sizes 020 – 090
- Door heights: Standard Vidmar sizes 140 – 165 Series
- Black end caps standard

Options:

- Adjustable shelves available in 400 lbs. and 800 lbs. capacities
- Drawer partitions and dividers available
- Ribbed rubber mat or 1-3/4" thick hardwood tops
- Special configurations available upon request



RP1955AL - Ten Drawers

Workcenter Height - 42" (includes work surface)
45" (1143mm) Extra-Wide Width
27-3/4" (705mm) Standard Depth

| DRAWERS | DRAWER MODEL # | USABLE HEIGHT | COMPARTMENTS | LOADING DIAGRAM # |
|---------|----------------|-----------------|--------------|-------------------|
| 1 | XW30BKFW | 3-7/8" (98mm) | 1 | – |
| 3 | SV25BK | 3" (76mm) | 1 | – |
| 1 | SV40BK | 5-3/8" (137mm) | 1 | – |
| 1 | SV50BK | 7" (178mm) | 1 | – |
| 2 | SV30BK | 3-7/8" (98mm) | 1 | – |
| 1 | SV35BK | 4-5/8" (117mm) | 1 | – |
| 1 | SV70BK | 10-1/8" (257mm) | 1 | – |



RP1953AL - Ten Drawers

Workcenter Height - 42" (includes work surface)
60" (1524mm) Double-Wide Width
27-3/4" (705mm) Standard Depth

| DRAWERS | DRAWER MODEL # | USABLE HEIGHT | COMPARTMENTS | LOADING DIAGRAM # |
|---------|----------------|-----------------|--------------|-------------------|
| 1 | DW30BKFW | 3-7/8" (98mm) | 1 | – |
| 3 | 25BK | 3" (76mm) | 1 | – |
| 1 | 40BK | 5-3/8" (137mm) | 1 | – |
| 1 | 50BK | 7" (178mm) | 1 | – |
| 2 | 30BK | 3-7/8" (98mm) | 1 | – |
| 1 | 35BK | 4-5/8" (117mm) | 1 | – |
| 1 | 70BK | 10-1/8" (257mm) | 1 | – |

PASS-THROUGH CABINETS

- Ideal for storage of long bulky items
- Available with or without doors and shelves
- Stand alone or back-to-back to best meet your storage needs
- Available with or without doors and shelves



Pass-Through Cabinet Model

| | PT (STD) | XWPT | XLPT | DWPT | DLPT |
|----------------------|--------------|-----------|-----------|-----------|-----------|
| Pass-Through Housing | PTXXXX | XWPTXXXX | XLPTXXXX | DWPTXXXX | DLPTXXXX |
| Door | SDDXXXXR/LH* | XWSDDXXXX | XWSDDXXXX | DWSDDXXXX | DWSDDXXXX |
| Shelf | PTCS40 | XWPTCS40 | XLPTCS80 | DWPTCS40 | DLPTCS80 |
| Bottom Pan | PTBP80 | XWPTBP80 | XLPTBP80 | DWPTBP80 | DLPTBP80 |

** Please specify right- or left-hand hinge

COMPUTER CABINETS

- Ultimate platform for high-impact computer storage and performance
- Designed to accommodate an array of computer housing situations, from shop floors to warehouses to military shipboards
- Available in other sizes



PCC0340A
30" W x 27-3/4" D x 65" H
(762mm W x 711mm D x 1651mm H)



PCM0340A
30" W x 27-3/4" D x 65" H
(762mm W x 711mm D x 1651mm H)

CABINETS: Safety Cabinets

SAFETY CABINETS

- Constructed from 180-gauge steel with double walls on tops, sides, bottoms, and doors (double walls integrate a 1-1/2" airspace for added safety)
- Two side vents, both with 2" threaded fittings
- Fire baffle end cap
- High-gloss epoxy powder coatings inside and out



CABINETS

Acid/Corrosive Safety Cabinet

- Designed for the storage of up to 5 gallon containers of flammable and nonflammable acids and corrosive liquids
- Coated with blue epoxy powder coating for superior protection against chemical spills and splashes

Acid/Corrosive Safety Cabinet Models

| MODEL #* | DOOR SPECS | CAPACITY | APPROVAL | WIDTH | DEPTH | HEIGHT | SHELF DEPTH | SHELVES | SHELF TRAYS | BTM TRAYS | WEIGHT |
|----------|------------|-------------------|----------|---------|---------|--------|-------------|---------|-------------|-----------|---------------------|
| CAC30M | 2 Doors | 30 gal. (114L) | FM | 43" | 18" | 44" | 14-3/4" | 1 | 1 | 1 | 253 lbs. (115kg) |
| CAC45M | 2 Doors | 45 gal. (170L) | FM | 43" | 18" | 65" | 14-3/4" | 2 | 2 | 1 | 351 lbs. (159kg) |
| CAC60M | 2 Doors | 60 gal. (227L) | FM | 31-1/4" | 31-1/4" | 65" | 28" | 2 | 2 | 1 | 363 lbs. (165kg) |

*M — Manual doors

Weight includes packaging

Paint/Ink Safety Cabinet

- Safely store printing inks and other paint products
- Cabinets finished with a high-gloss yellow epoxy

Paint/Ink Safety Cabinet Models

| MODEL # | DOOR SPECS | CAPACITY | APPROVAL | WIDTH | DEPTH | HEIGHT | SHELF DEPTH | SHELVES | WEIGHT |
|---------|------------|-------------------|----------|-------|-------|--------|-------------|---------|---------------------|
| PIC40M | 2 Doors | 40 gal. (151L) | FM | 43" | 18" | 44" | 14-3/4" | 3 | 272 lbs. (123kg) |
| PIC60M | 2 Doors | 60 gal. (227L) | FM | 43" | 18" | 65" | 14-3/4" | 5 | 380 lbs. (172kg) |

Weight includes packaging

Flammable Safety Cabinet

- Keep required flammable liquids safely near work areas
- Coated with high-gloss yellow HazMat finish
- Meets OSHA requirements, NFPA Code 30 requirements, and FM approval

Flammables Safety Cabinet Models

| MODEL #* | DOOR SPECS | CAPACITY | APPROVAL | WIDTH | DEPTH | HEIGHT | SHELF DEPTH | SHELVES | WEIGHT |
|----------|------------|-------------------|----------|---------|---------|--------|-------------|---------|---------------------|
| FLC30M | 2 Doors | 30 gal. (114L) | FM | 43" | 18" | 44" | 14-3/4" | 1 | 247 lbs. (112kg) |
| FLC30SC | 2 Doors | 30 gal. (114L) | FM | 43" | 18" | 44" | 14-3/4" | 1 | 257 lbs. (117kg) |
| FLC45M | 2 Doors | 45 gal. (170L) | FM | 43" | 18" | 65" | 14-3/4" | 2 | 342 lbs. (155kg) |
| FLC45SC | 2 Doors | 45 gal. (170L) | FM | 43" | 18" | 65" | 14-3/4" | 2 | 353 lbs. (160kg) |
| FLC60M | 2 Doors | 60 gal. (227L) | FM | 31-1/4" | 31-1/4" | 65" | 28" | 2 | 354 lbs. (161kg) |
| FLC60SC | 2 Doors | 60 gal. (227L) | FM | 31-1/4" | 31-1/4" | 65" | 28" | 2 | 364 lbs. (165kg) |

*M — Manual doors

Weight includes packaging

Safety Cabinet Accessories

- Accessories include metal shelves, epoxy-coated metal shelves, polyethylene bottom trays, polyethylene shelf trays, and self-closing adapter kits

Safety Cabinet Accessories

| MODEL # | TYPE | DESCRIPTION |
|----------|--------------------------|---|
| CAS-XX | Epoxy-Coated Metal Shelf | Specify Capacity of 30, 45, or 60 gal. (114, 170, or 227L)* |
| FLS-XX | Metal Shelf | Specify Capacity of 30, 45, or 60 gal. (114, 170, or 227L)* |
| PIS-XX | Metal Shelf | Specify Capacity of 40 or 60 gal. (151 or 227L)* |
| CAPBT-XX | Poly. Bottom Tray | Specify Capacity of 30, 45, or 60 gal. (114, 170, or 227L)* |
| CAPST-XX | Poly. Shelf Tray | Specify Capacity of 30, 45, or 60 gal. (114, 170, or 227L)* |
| FLAK | Adapter Kits | All Flammable |
| CAAK | Adapter Kits | All Acid/Corrosive |
| PIAK | Adapter Kits | All Paint/Ink |

FULLY LOADED MODULARITY

Completely modular, Vidmar® mezzanine systems can be reconfigured as often as necessary—even when fully loaded. Constructed to the same super-tough standards as the rest of Vidmar’s storage components, mezzanines are available in a variety of convenient systems.

MiniMezz™ System

- Consists of two rows of stacked storage cabinets plus stairs, railings, and a walking mat placed over the lower row
- Configure with any Vidmar cabinet (recommend standard 340’s for bottom row)



Mezzanine expansion modules allow your system to grow as you grow. Aisle and pass-through modules enable you to build your system around your unique space requirements and traffic patterns.

CABINETS: Mezzanine

MaxiMezz™ System

- Cabinets stacked two-high into rows, with an intermediate shelf cabinet between the top and bottom cabinets
- Includes walkway support system, grating, stairs, and railings
- Multiple configurations available

All mezzanine systems are backed by Vidmar's lifetime warranty.



MaxiMezz™ includes walkway support system, grating and railings



WEAPONS STORAGE AND CRADLE

The security of your weapons is of the highest priority. So is knowing they're exactly where you need them when you need them most. Settle for nothing less than Vidmar heavy-duty weapons storage:

- Highest level of security for contents with integrated locking mechanism
- Additional layer of safety and security with shock bar
- Verified as meeting the requirements of paragraph 4 (a–d) of the Small Arms Storage Rack Certification Document, part of **AR 190-11** for the physical security of arms, ammunition, and explosives
- Weapons cradles configured to your unique requirements
- Easily integrated into a variety of Vidmar storage systems
- Extreme space savings over racking-style weapon storage—approximately **40-45 weapons vs. 10**



Pictured: STD0175 with 2-35, 1-40, 1-65 with STPD165 HLB1751, HLBL1751 and Hardwood Top in Dark Blue (S22578)



Pictured: DW70 Drawer with WCP-UNIV-ST in Dark Blue (S22578)



Whether you need to store a roomful of rifles or a warehouse full of large field weapons, Vidmar weapons cradles can be configured to accommodate your precise needs.



Available for an array of standard-issue weaponry, Vidmar weapons cradles ensure that none of your weaponry ends up in the wrong hands.



Pictured: DW0340 with 2-DW65, 3-DW70, HLB3401, and HLB3401 in Dark Blue (S22578)

SPECIALTY STORAGE: Weapons Storage

SECURE, CUSTOMIZABLE, AND BUILT TO LAST

- Designed to meet the unique needs of military and law enforcement, Vidmar® Vertical Weapon Storage System is our most versatile weapons storage solution yet
- Strong and secure, it keeps up to 18 M4s, M16s, or M870 shotguns protected and can be custom-configured to store various combinations of weaponry, ammunition, and equipment



Weapons able to be stored

- | | |
|------------------|-----------------------------|
| M9 (9MM) | GAU19 |
| M16 | GAU21 |
| M4 with scopes | SNIPER RIFLES |
| M240 with scopes | FOREIGN WEAPONS |
| M249 | SCOPES |
| M2 | TRIPODS |
| M203 | Satellite Navigation System |
| M320 | NVG |
| MK19 | Bayonet |
| M1200 | Laser Marker |
| M134 | NSN AVAILABLE |
| M870 | (on selected cabinets) |
| M3P | |

High-Density Configurations



- 4 M2s or M19s
- 6 M240s or M249s
- 12 or 18 M4s
- 12 or 18 M16s
- 12 or 18 M870s

Ultimate customization

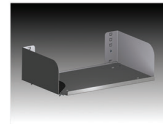

Shelves & Dividers

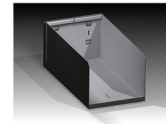

Ammo Storage & Boxes

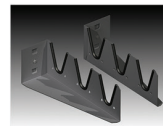

Horizontal Rifle Mount

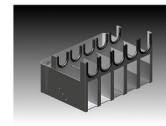

Pistol Cradles (and clips)

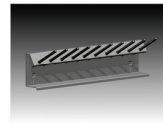

Pistol Post

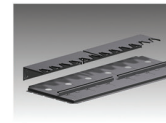

Rifle Base

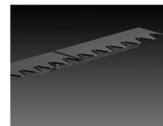

Stationary Barrel Cradle



Mobile Barrel Cradle

Safety

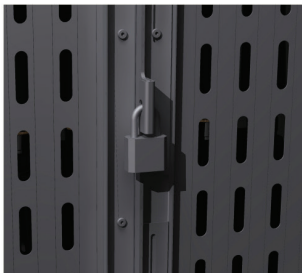

Fully secure with two hasp locks secure points plus the ability to bolt or daisy-chain with other cabinets

Mobility

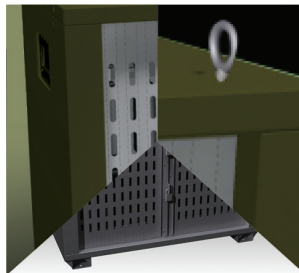

Easy deployment with mobile pallet base, handle, or optional lifting eye

Accessibility



See what's inside with robust, perforated, horizontal tambour doors

Modularity



Conveniently stacks and integrates with other Vidmar systems to save space

RAPID DEPLOYMENT CONTAINER INSERT

Flexible. Expandable. Dependable.

- Designed for high density storage of tools, parts, and weapons
- Custom-configured for new or existing quad-cons, tri-cons, and 20-foot containers
- Customizable drawer options as well as a four-way forkliftable base for quick and easy deployment
- Handles loads up to 4,000 lbs. per individual unit or 8,000 lbs. per stacked unit



Deployment base accepts pallet jacks for transporting around the facility without a fork truck



Units available with cross bracing or panels depending on storage and security needs



Built to last with Vidmar's lifetime warranty

SPECIALTY STORAGE: Lockers

SAFELY STORE YOUR PERSONAL PROTECTION EQUIPMENT (PPE) AND OTHER GEAR.

Vidmar makes the protection and organization of PPE effortless.

- Dedicated drawer storage that prevents the unnecessary handling of items, thereby increasing the shelf life of expensive PPE
- Identical drawer loading diagrams that help expedite frequent PPE inspections
- Expanded storage space to store outerwear, boots, and other personal items
- Space-saving personal protection solutions that can reduce your overall footprint
- Flexible modular storage solutions that can be infinitely expanded



Lockable upper storage compartment protects your belongings



Store everything from breathing apparatuses and ear/eye protection to gloves and clothing



Locker hooks

ESD CABINETS

- Full line of Electro-Static Dissipative (ESD)-protective storage equipment designed to help create a static-safe work environment
- All StaticGard™ storage components adhere to ESD Association Standards, protecting against static damage both on and below your work surfaces



ESD Cabinets

STATICGARD™ WORKSTATIONS

- All StaticGard™ workstations feature a static-dissipative top with a common grounding point for equipment and personnel, plus wrist strap.
- Preconfigured StaticGard™ workstations include StaticGard™ Maintenance Workstation, StaticGard™ Technician's Workstation, StaticGard™ Inspector's Workstation, and StaticGard™ Packer's Workstation
- StaticGard™ Sentry 100 Workstation, tested and certified to 100 volts using ESD Association criteria
- StaticGard™ workstations can also be custom-configured to any specifications your workspace requires



StaticGard™ Workstations: EPW-1



StaticGard™ Workstations: EIW-1



StaticGard™ Workstations: EMW-1

SPECIALTY STORAGE: StaticGard™/ESD

STATICGARD™ ACCESSORIES

Vidmar offers a number of accessories designed to make sure your StaticGard™ components meet your every need:

- **Mobile Casters:** Turn your StaticGard™ storage equipment into mobile StaticGard™ storage equipment
- **Partitions & Dividers:** StaticGard™ drawer partitions and dividers are made with a special coating and materials that make them safe for use in static-sensitive areas
- **Quarter Trays:** Quarter trays take up one-quarter of a standard drawer and are divided into 20 equal-sized compartments
- **Bins & Bin Dividers:** Ideal for smaller items, plastic bins and dividers can be easily removed for handling, issuing, and counting. Bins can be divided into smaller compartments with bin dividers; use snap-on label holders and paper labels to organize bin contents
- **Customize your StaticGard™ drawers into any configuration you need**



StaticGard™ Maintenance Workstation: EMW-1

| DRAWERS | DRAWER MODEL # | USABLE HEIGHT | COMPARTMENTS | LOADING DIAGRAM # |
|---------|----------------|-----------------|--------------|-------------------|
| CAB1 | | | | |
| 1 | SG20 | 2-1/4" (57mm) | 64 | SGLDQT88 |
| 1 | SG20 | 2-1/4" (57mm) | 24 | SGLD86 |
| 1 | SG20 | 2-1/4" (57mm) | 64 | SGLDBN48 |
| 1 | SG50 | 7" (178mm) | 12 | SGLD108 |
| 1 | SG65 | 9" (229mm) | 8 | SGLD168 |
| CAB2 | | | | |
| 1 | SG20 | 2-1/4" (57mm) | 24 | SGLD85 |
| 1 | SG20 | 2-1/4" (57mm) | 32 | SGLD48 |
| 1 | SG30 | 3-7/8" (98mm) | 24 | SGLD85 |
| 1 | SG30 | 3-7/8" (98mm) | 20 | SGLD86 |
| 1 | SG30 | 3-7/8" (98mm) | 16 | SGLD88 |
| 1 | SG30 | 3-7/8" (98mm) | 12 | SGLD108 |
| 1 | SG40 | 5-3/8" (137mm) | 12 | SGLD108 |
| 1 | SG50 | 7" (178mm) | 8 | SGLD168 |
| 1 | SG90 | 13-1/4" (337mm) | 8 | SGLD168 |

Also includes: SGBC1751, SGFRBC042, SGWS72361, SGWS721820ABA, SGBPWSS7220A, FL04807200

PRECONFIGURED STATICGARD™ WORKSTATIONS

- StaticGard™ workstations are available in many more preconfigured styles, and can also be custom-configured to any specifications you may require

All Vidmar® cabinets and workstations can be converted to StaticGard™ cabinets and workstations.



StaticGard™ Technician's Workstation: ETW-1

| DRAWERS | DRAWER MODEL # | USABLE HEIGHT | COMPARTMENTS | LOADING DIAGRAM # |
|---------|----------------|----------------|--------------|-------------------|
| 1 | SG20 | 2-1/4" (57mm) | 64 | SGLDBN64 |
| 1 | SG25 | 3" (76mm) | 64 | SGLDBN64 |
| 1 | SG25 | 3" (76mm) | 16 | SG88 |
| 1 | SG35 | 4-5/8" (117mm) | 16 | SG88 |
| 1 | SG50 | 7" (178mm) | 9 | SGLD1010 |

Also includes: SGBC1551, SGFRBC042, SGWS72361, SGWS721820ABA, SGBPWSS7220A, FL04807200



StaticGard™ Inspector's Workstation: EIW-1

| DRAWERS | DRAWER MODEL # | USABLE HEIGHT | COMPARTMENTS | LOADING DIAGRAM # |
|---------|----------------|----------------|--------------|-------------------|
| 2 | SG20 | 2-1/4" (57mm) | 64 | SGLDBN64 |
| 1 | SG25 | 3" (76mm) | 16 | SGLD88 |
| 1 | SG40 | 5-3/8" (137mm) | 16 | SGLD88 |
| 1 | SG50 | 7" (178mm) | 9 | SGLD1010 |

Also includes: SGBC1551, SGFRBC042, SGWS72361, SGWS5721820, FLO48072W



StaticGard™ Packer's Workstation: EPW-1

| DRAWERS | DRAWER MODEL # | USABLE HEIGHT | COMPARTMENTS | LOADING DIAGRAM # |
|---------|----------------|-----------------|--------------|-------------------|
| 1 | SG20 | 2-1/4" (57mm) | 24 | SGLD85 |
| 1 | SG20 | 2-1/4" (57mm) | 20 | SGLD86 |
| 1 | SG45 | 6-1/4" (159mm) | 16 | SGLD88 |
| 1 | SG90 | 13-1/4" (337mm) | 4 | SGLD1616 |

Also includes: SGBC1551, SGFRBC042, SGWS72361



StaticGard™ Preconfigured 0175 SGSEP1023AL - Five Drawers

| DRAWERS | DRAWER MODEL # | USABLE HEIGHT | COMPARTMENTS | LOADING DIAGRAM # |
|---------|----------------|----------------|--------------|-------------------|
| 1 | SG20 | 2-1/4" (57mm) | 24 | SGLD58 |
| 1 | SG25 | 3" (76mm) | 20 | SGLD68 |
| 1 | SG30 | 3-7/8" (98mm) | 20 | SGLD68 |
| 1 | SG40 | 5-3/8" (137mm) | 16 | SGLD88 |
| 1 | SG60 | 8-1/2" (216mm) | 12 | SGLD108 |



StaticGard™ Preconfigured 0175 SGSEP1004AL - Six Drawers

| DRAWERS | DRAWER MODEL # | USABLE HEIGHT | COMPARTMENTS | LOADING DIAGRAM # |
|---------|----------------|---------------|--------------|-------------------|
| 1 | SG20 | 2-1/4" (57mm) | 24 | SGLD58 |
| 1 | SG20 | 2-1/4" (57mm) | 20 | SGLD68 |
| 1 | SG25 | 3" (76mm) | 16 | SGLD88 |
| 1 | SG30 | 3-7/8" (98mm) | 20 | SGLD68 |
| 1 | SG30 | 3-7/8" (98mm) | 16 | SGLD88 |
| 1 | SG50 | 7" (178mm) | 12 | SGLD108 |

SPECIALTY STORAGE: StaticGard™/ESD

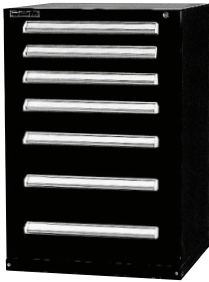

**StaticGard™ Preconfigured 0245
SGRP2102AL - Seven Drawers**

| DRAWERS | DRAWER MODEL # | USABLE HEIGHT | COMPARTMENTS | LOADING DIAGRAM # |
|---------|----------------|----------------|--------------|-------------------|
| 1 | SG20 | 2-1/4" (57mm) | 32 | SGLD84 |
| 1 | SG25 | 3" (76mm) | 20 | SGLD86 |
| 1 | SG30 | 3-7/8" (98mm) | 20 | SGLD86 |
| 1 | SG30 | 3-7/8" (98mm) | 16 | SGLD88 |
| 1 | SG40 | 5-3/8" (137mm) | 12 | SGLD108 |
| 1 | SG50 | 7" (178mm) | 8 | SGLD168 |
| 1 | SG50 | 7" (178mm) | 6 | SGLD1610 |

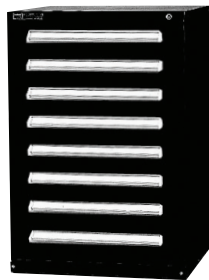

**StaticGard™ Preconfigured 0245
SGSEP2029AL - Eight Drawers**

| DRAWERS | DRAWER MODEL # | USABLE HEIGHT | COMPARTMENTS | LOADING DIAGRAM # |
|---------|----------------|----------------|--------------|-------------------|
| 7 | SG30 | 3-7/8" (98mm) | 20 | SGLD68 |
| 1 | SG35 | 4-5/8" (117mm) | 20 | SGLD68 |

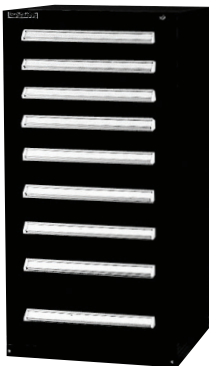

**StaticGard™ Preconfigured 0340
SGSEP3144AL - Nine Drawers**

| DRAWERS | DRAWER MODEL # | USABLE HEIGHT | COMPARTMENTS | LOADING DIAGRAM # |
|---------|----------------|----------------|--------------|-------------------|
| 1 | SG30 | 3-7/8" (98mm) | 24 | SGLD58 |
| 1 | SG30 | 3-7/8" (98mm) | 20 | SGLD68 |
| 1 | SG30 | 3-7/8" (98mm) | 16 | SGLD88 |
| 1 | SG30 | 3-7/8" (98mm) | 12 | SGLD108 |
| 1 | SG40 | 5-3/8" (137mm) | 20 | SGLD68 |
| 1 | SG40 | 5-3/8" (137mm) | 16 | SGLD88 |
| 1 | SG40 | 5-3/8" (137mm) | 12 | SGLD108 |
| 1 | SG40 | 5-3/8" (137mm) | 8 | SGLD168 |
| 1 | SG60 | 8-1/2" (216mm) | 12 | SGLD108 |

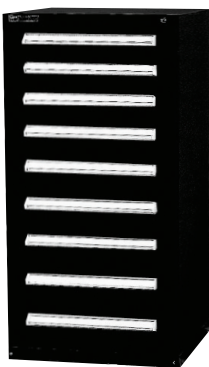

**StaticGard™ Preconfigured 0340
SGSEP3140AL - Nine Drawers**

| DRAWERS | DRAWER MODEL # | USABLE HEIGHT | COMPARTMENTS | LOADING DIAGRAM # |
|---------|----------------|----------------|--------------|-------------------|
| 1 | SG30 | 3-7/8" (98mm) | 24 | SGLD58 |
| 1 | SG30 | 3-7/8" (98mm) | 20 | SGLD68 |
| 1 | SG35 | 4-5/8" (117mm) | 16 | SGLD88 |
| 1 | SG35 | 4-5/8" (117mm) | 12 | SGLD108 |
| 1 | SG40 | 5-3/8" (137mm) | 20 | SGLD68 |
| 2 | SG40 | 5-3/8" (137mm) | 16 | SGLD88 |
| 1 | SG45 | 6-1/4" (159mm) | 12 | SGLD108 |
| 1 | SG45 | 6-1/4" (159mm) | 8 | SGLD168 |



Built Vidmar-tough for performance that lasts and ergonomically designed to ensure proper body support, Tough Seating is available in an array of styles for specific job tasks. See page 106

FULFILL LEAN, 6S, AND KAIZEN STORAGE REQUIREMENTS

- Ideal for manufacturing facilities, military, and businesses working on Lean-related initiatives
- Instant Visibility: Clear acrylic doors allow at-a-glance tool and/or parts inventory. Or choose the solid hinged door option with metal pegboard inserts to optimize every inch of the cabinet
- Point-of-Use Storage: Store frequently used items where you need them. Choose from various widths and heights
- Secure Storage: Heavy-duty lock and key system that is virtually impossible to duplicate enables the safe storage of valuable items in a visible location
- Lifetime Guarantee: We protect your investment. All Vidmar® cabinets are backed by this unparalleled industry promise

Side and rear panel pegboard for organized tool storage

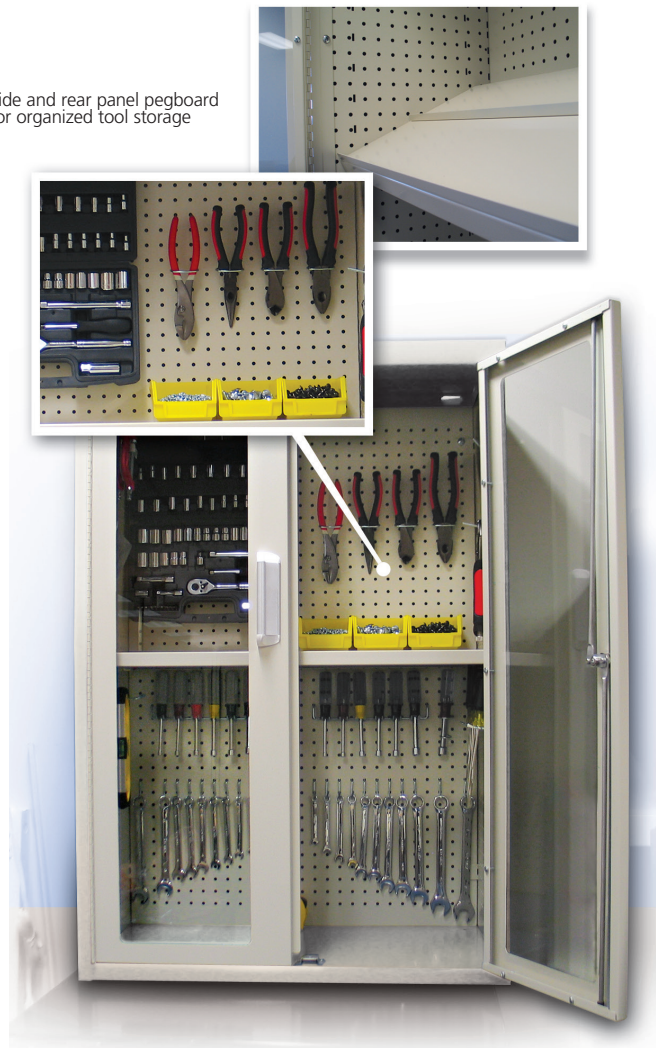

Available in 30, 45, 60" wide and 17, 27, 30, 33, and 44" tall



Metal pegboard inserts

Solid hinged doors

SPECIALTY STORAGE: 6S



6S cabinets optimize workflow and improve efficiency



Ideal for point-of-use storage



NC TOOL STORAGE

- Start working more efficiently by organizing your NC tools as well as your inventory
- Constructed from extruded aluminum, Vidmar® NC tool storage components are designed to carry all of your tools in a safe, well-organized fashion
- Choose your Vidmar® tool holders based on the size and style of the tool assemblies to be handled: V-flange tooling, straight shank tooling, or modular tooling

23" TOOLHOLDER INSERTS

- Toolholder inserts 23" (584mm) are used with lift-out trays and accomplish the same purpose as single toolholder inserts but when side-to-side spacing of tool assemblies is constant

25" FIXED TOOLHOLDERS

- Fixed toolholders 25" long (635mm) are used when side-to-side spacing of tool assemblies is constant and removable toolholders are not required
- Lift-out tool trays are used to move multiple tool assemblies by hand from tool taxis to tool storage devices or workbenches.

Note: Lift-out trays are not recommended with tools larger than 40 V-flange due to ergonomic considerations.



Pictured: VTT200 with 8-TH2532M5 in Bright Blue (S22447)



Pictured: STD02W with 1-20, 3-30, 1-90, 1-DRPs02 with 5-TH2532M5 in Bright Blue (S22447) Housing and Off-White (S22570) Drawers



23" (584mm) Toolholder Inserts



25" (635mm) Fixed Toolholders

SPECIALTY STORAGE: NC Tool Storage

Three steps to determine which toolholder arrangement is best for you.

1. Decide whether fixed toolholders or lift-out trays will work best
2. If lift-out tool trays are used 23" (584mm) long toolholder inserts will work best for you
3. Choose the specific model number based on the size and style of tool assemblies to be handled

CNC TOOL STORAGE CABINET

- Available in two heights and 12 drawer configurations
- Includes patented Single Drawer Release feature to prevent opening more than one drawer at a time
- Models listed include five 25" (635mm) fixed toolholders in each drawer
- All CNC cabinets must be securely anchored to the floor or bolted back to back
- Drawers may also have a full front

TOOL TAXI

- Designed to meet your tool storage and delivery requirements
- Available with a range of accessories including: rear tray, storage cabinet with lockable door, adjustable shelf, card holder for paperwork, etc.
- For increased capacity, fixed 22" (559mm) toolholders can be provided for attachment to the front or rear of the tool taxi



NC Tool Storage



Model # VTT200xxx/N



Model # VTT222xxx/N



Model # VTT211xxx/N

FLOOR STAND TOOL RACK

Model # FLTHR

- A simple inexpensive means of storing tooling at machining centers or work areas
- Either single or 23" (584mm) toolholder inserts (both shown) attach to extruded aluminum toolholder rails without screws or hand tools
- Three model THR-23 toolholder rails are included
- Up to 10 positions are available for toolholder rails on each side
- Toolholders and trays are ordered separately
- 27-1/4" (705mm) x 26-3/4" (679mm) x 59" (1499mm)

Note: Shipped knocked down. All floor stands should be securely anchored.



Floor Stand Tool Rack

UNIVERSAL FLOOR STAND

Model # FLTS

- Designed to work with tool taxis or CNC storage cabinets
- Provide ready access to preset tooling adjacent to machining areas
- The tool stand will accept either 10 fixed toolholders (as shown), six lift-out trays, or a combination of each
- Toolholders and trays are ordered separately
- 24-3/16" (614mm) x 28" (711mm) x 59-3/16" (1503mm)

Note: Shipped knocked down. All floor stands should be securely anchored.



Universal Floor Stand

SPECIALTY STORAGE: NC Tool Storage

BENCHTOP TOOL STAND

Model # BTTS

- Stores three rows of toolholders or lift-out trays
- Accepts either lift-out trays or fixed toolholders
- 18-7/16" (468mm) x 27" (686mm) x 12-3/16" (310mm)
- Shipped knocked down



Benchtop Tool Stand

BENCHTOP TOOL RACK

Model # BTTR

- Holds tooling on a bench or other work surface
- 8" (203mm) x 24" (610mm) x 8" (203mm)
- Includes one THR-23 toolholder rail
- Toolholders not included
- Shipped knocked down



Benchtop Tool Rack

TOOLHOLDERS AND ACCESSORIES Toolholders and Accessories

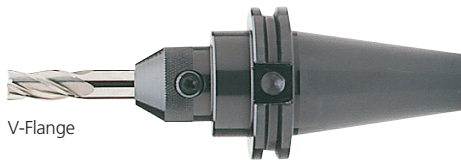

V-Flange



Straight Shank

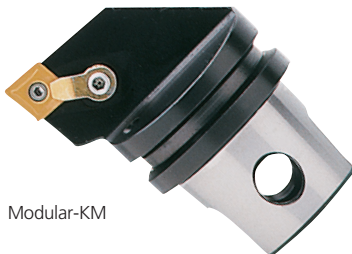

Modular-KM

| | TOOL SIZE | 23" (584MM) TOOLHOLDER INSERT | | 25" (635MM) TOOLHOLDER | |
|--|-------------------------|-------------------------------|-----------|------------------------|-----------|
| | | MODEL # | TOOL CAP. | MODEL # | TOOL CAP. |
| V-Flange | 050 V-Flange | TH2350V5 | 5 | TH2550V5 | 5 |
| | 45 V-Flange | TH2345V5 | 5 | TH2545V5 | 5 |
| | 40 V-Flange | TH2340V8 | 8 | TH2540V8 | 8 |
| | 30 V-Flange | TH2330V8 | 8 | TH2530V8 | 8 |
| Straight Shank | 2-1/2" (64mm) St. Shank | TH23250ST5 | 5 | TH25250ST5 | 5 |
| | 2-1/4" (57mm) St. Shank | TH23225ST5 | 5 | TH25225ST5 | 5 |
| | 2" (51mm) St. Shank | TH23200ST8 | 8 | TH25200ST8 | 8 |
| | 1-3/4" (44mm) St. Shank | TH23175ST8 | 8 | TH25175ST8 | 8 |
| | 1-1/2" (38mm) St. Shank | TH23150ST8 | 8 | TH25150ST8 | 8 |
| | 1-1/4" (32mm) St. Shank | TH23125ST8 | 8 | TH25125ST8 | 8 |
| | 1" (25mm) St. Shank | TH23100ST8 | 8 | TH25100ST8 | 8 |
| Modular-CAPTO | | TH23C38 | 8 | TH25C38 | 8 |
| | | TH23C48 | 8 | TH25C48 | 8 |
| | | TH23C58 | 8 | TH25C58 | 8 |
| | | TH23C68 | 8 | TH25C68 | 8 |
| | | TH23C85 | 5 | TH25C85 | 5 |
| Modular-HSK | | TH23HSK328 | 8 | TH25HSK328 | 8 |
| | | TH23HSK408 | 8 | TH25HSK408 | 8 |
| | | TH23HSK508 | 8 | TH25HSK508 | 8 |
| | | TH23HSK638 | 8 | TH25HSK638 | 8 |
| | | TH23HSK805 | 5 | TH25HSK805 | 5 |
| Modular-KM <small>(special adapters also available for TM Smith tooling)</small> | 32KM Modular | TH2332M8 | 8 | TH2532M8 | 8 |
| | 40KM Modular | TH2340M8 | 8 | TH2540M8 | 8 |
| | 50KM Modular | TH2350M5 | 5 | TH2550M8 | 8 |
| | 63KM Modular | TH2363M5 | 5 | TH2563M5 | 5 |
| Miscellaneous | Blank Aluminum | TH23000 | Variable | TH25000 | Variable |
| | Blank Alum (Short) | TH2300S0 | Variable | TH2500S0 | Variable |
| | #200 Kwik Switch | TH23200Q10 | 10 | TH25200Q10 | 10 |
| | #300 Kwik Switch | TH23300Q9 | 9 | TH25300Q9 | 9 |

Lift-Out Tray

| MODEL # | A, B, IN. (MM) | MIN. IN. (MM) | DRAWER SIZE |
|---------|----------------------|-----------------|-------------|
| TT625 | 6" (153mm) | 11-1/4" (286mm) | #80 |
| TT450 | Less than 4" (102mm) | 9-3/16" (233mm) | #65 |

Drawer Toolholder Supports - 25" (635mm)

| MODEL # | DESCRIPTION | ² HEIGHT |
|---------|---|---------------------|
| DRPS02 | Supports for HSK straight shank KM or CAPTO | 2" (51mm) |
| DRPS03 | ¹ Supports for 30V | 3" (76mm) |
| DRPS04 | ¹ Supports for 40V and 45V (pair) | 4-1/4" (108mm) |
| DRPS05 | ¹ Supports for 50V (pair) | 5-1/4" (133mm) |
| DRPS06 | Supports to allow for longer retention knob lengths | 6-1/4" (159mm) |

¹Drawer toolholder supports assume that standard retention knobs with extensions of less than 1" (25mm) are used (V-flange tooling only)

²Height is measured from bottom of drawer to top of toolholder

SPECIALTY STORAGE

CORNER DESK

- Provides remote working space and extra storage space for manuals and records
- Designed to complete a corner turn when cabinets are arranged in an "L" or square formation
- Desks are 44" (1118mm) high and occupy the space of two standard cabinets and one corner spacer
- Features include fluorescent light with switch and bookcase with two shelves (see bookcase section on page 86 for additional bookcase options)



Corner Desk

Corner Desk

| MODEL # | DESCRIPTION |
|---------|-----------------------------------|
| CDA58R | Right-Hand Corner Desk |
| CDA58L | Left-Hand Corner Desk |
| MLPT58R | Laminated Top for Right-Hand Desk |
| MLPT58L | Laminated Top for Left-Hand Desk |

STRAIGHT DESK

- Provides writing surface and supervisory work areas
- Available in 30" (762mm) and 60" (1524mm) widths and 44" (1118mm) height
- Features include fluorescent light with switch and laminated writing surface with knockouts for wiring access



Straight Desk

Straight Desk

| MODEL # | DESCRIPTION |
|---------|---|
| SDA30 | 30" (762mm) Straight Desk |
| SDA60 | 60" (1524mm) Straight Desk |
| MLPT30 | Laminated Top for Upper Shelf, 30" (762mm) |
| MLPT60 | Laminated Top for Upper Shelf, 60" (1524mm) |

SPECIALTY STORAGE: Desks

MOBILE CONTROL CENTER

- Universal components: standard 245 cabinet, corner desk/bookcase, safety panel, and integral pallet base
- Easy to assemble in any configuration
- Well-lit workspace and counter surface around two sides
- Safety panel prevents chair roll-away and buffers noise
- Pallet base allows effortless relocation with forklift
- Available knocked down or fully assembled



SLOPE TOP DESK

Model # DST30 (For Standard Cabinet)
Model # DST45 (For Extra-Wide Cabinet)
Model # DST60 (For Double-Wide Cabinet)

- Designed for use where report or record-keeping space is limited
- Fits on top of standard size cabinet
- Equipped with pencil holder and clipboard clasp
- Hinged at rear, desktop opens to provide additional storage space beneath writing surface
- Lid support included to hold writing surface in open position



TYPE A STRAIGHT WORKSTATIONS

- These attractive, rugged workstations are designed to meet today's demanding benching requirements
- The modular characteristics of the workstations provide many different benching options. And when relocation becomes necessary, moving the modular workstation is easy
- Disassembly is simple, as is moving fully loaded cabinets
- And remember...You can always add to any modular workstation when expansion becomes necessary
- To meet your specific workstation needs, simply select the exact storage components and work surface that match your requirements
- Available in different heights, depths and widths



Type A



A-1: 1-SEP1023AL, HT60, BL1751



A-2: 1-SEP1023AL, HT60, BL1751, BS360, ES330



A-3: 1-SEP1023AL, HT60, BL1751, BFS60



A-4: 1-SEP1023AL, HT60, BL1751, BFS60, BPBFS60, ES330



A-5: 1-SEP1023AL, 1-SEP1031AL, HT84



A-6: 1-SEP1023AL, 1-SEP1031AL, HT84, BS384, ES330



A-7: 1-SEP1023AL, 1-SEP1031AL, HT84, BFS84



A-8: 1-SEP1023AL, 1-SEP1031AL, HT84, BFS84, BPBFS84, ES330



A-9: 1-SEP1023AL, HT72, 2-BL1751



A-10: 1-SEP1023AL, HT72, 2-BL1751, BS372, ES330



A-11: 1-SEP1023AL, HT72, 2-BL1751, BFS72



A-12: 1-SEP1023AL, HT72, 2-BL1751, BFS72, BPBFS72, ES330

WORKSTATIONS & BENCHING: Preconfigured



TYPE B CORNER WORKSTATIONS

- Vidmar® corner workstations fill a specific need in benching requirements for corner and right-angle configurations
- Wasted corner space is eliminated
- Cabinets, work surfaces, and a complete line of accessories flow at right angles for maximum operator efficiency and convenience
- Drawer storage is never more than a comfortable arm's length away. Right-angle capabilities now offer unlimited work center layouts in clusters configured face-to-face, back-to-back, or side-by-side to take full advantage of available space, lighting, and room layout.



Type B



B-1: 1-SEP1023AL, 2-BL1751, HT90, HT60, SP



B-2: 1-SEP1023AL, 2-BL1751, HT90, HT60, SP, ES330, BS390, BS360



B-3: 1-SEP1023AL, 2-BL1751, HT90, HT60, SP, 2, BFS60, CBFS30



B-4: 1-SEP1023AL, 2-BL1751, HT90, HT60, SP, ES330, 2-BFS60, CBFS30, 2-BPBF560, 2-BPBF530



B-5: 1-SEP1023AL, 1-SEP1037AL, BL1751, HT90, HT60, SP



B-6: 1-SEP1023AL, 1-SEP1037AL, BL1751, HT90, HT60, SP, ES330, BS390, BS360



B-7: 1-SEP1023AL, 1-SEP1037AL, BL1751, HT90, HT60, SP, 2-BFS60, CBFS30



B-8: 1-SEP1023AL, 1-SEP1037AL, BL1751, HT90, HT60, SP, 2-BFS60, CBFS30, 2-BPBF560, 2-BPBF530

TYPE C HI-LO WORKSTATIONS

- Hi-lo workstations offer a wide variety of configurations with maximum storage capacity by using the full range of modular storage drawer cabinets with various work surface designs
- You may select the right combinations that meet your workstation requirements without being restricted by floor space allocations and materials to be stored or used in the workstation
- Drawers can be easily arranged so their labels, compartments, and contents are always facing the operator, in order to keep moving, reaching, and lifting to a minimum



Type C

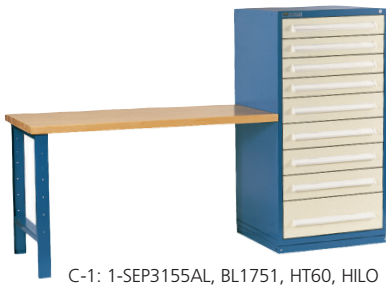

C-1: 1-SEP3155AL, BL1751, HT60, HILO

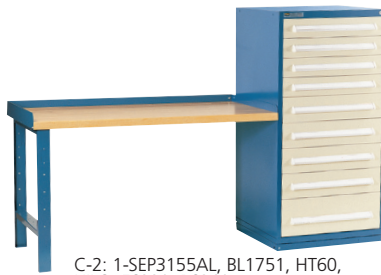

C-2: 1-SEP3155AL, BL1751, HT60, HILO, ES330, BS360



C-3: 1-SEP3155AL, BL1751, HT60, HILO, BFS60



C-4: 1-SEP3155AL, BL1751, HT60, HILO, BFS60, BPBFS60, ES330



C-5: 1-SEP1023AL, 1-SEP3155AL, HT60, HILO



C-6: 1-SEP1023AL, 1-SEP3155AL, HT60, HILO, BS360, ES330



C-7: 1-SEP1023AL, 1-SEP3155AL, HT60, HILO, BFS60



C-8: 1-SEP1023AL, 1-SEP3155AL, HT60, HILO, BFS60, BPBFS60, ES330

WORKSTATIONS & BENCHING: Preconfigured



TYPE D CENTER WORKSTATIONS

- This center cabinet configuration is ideal for two-person workstations where each worker uses common parts and supplies, or shares work in process
- Additional cabinets can be added so that each worker has parts and supplies specifically needed for an operation, and can draw on parts from the central, common storage cabinet
- As with all workstations, there's no need to bend or stoop to look into hidden shelves, because the heavy-duty Vidmar® drawers roll easily out of the cabinets into full view for maximum efficiency



Type D



D-1: 1-SEP1037AL, 1-SEP1037AL, 1-SEP1031AL, HT90, HT60, HILO



D-2: 1-SEP1037AL, 1-SEP1037AL, 1-SEP1031AL, HT90, HT60, HILO, BS390, BS360, ES330



D-3: 1-SEP1037AL, 1-SEP1037AL, 1-SEP1031AL, HT90, HT60, HILO, BFS90, BFS60



D-4: 1-SEP1037AL, 1-SEP1037AL, 1-SEP1031AL, HT90, HT60, HILO, BFS90, BFS60, BPBFS90, BPBFS60, ES330



D-5: 1-SEP3155AL, 2-HT60, 2-BL1751, 2-HILO



D-6: 1-SEP3155AL, 2-HT60, 2-BL1751, 2-HILO, 2-BS360, ES330



D-7: 1-SEP3155AL, 2-HT60, 2-BL1751, 2-HILO, 2-BFS60



D-8: 1-SEP3155AL, 2-HT60, 2-BL1751, 2-HILO, 2-BFS60, 2-BPBFS60, ES330



D-9: 1-SEP3155AL, 1-SEP1023AL, 1-SEP1031AL, 2-HT60, 2-HILO



D-10: 1-SEP3155AL, 1-SEP1023AL, 1-SEP1031AL, 2-HT60, 2-BS360, ES330, 2-HILO

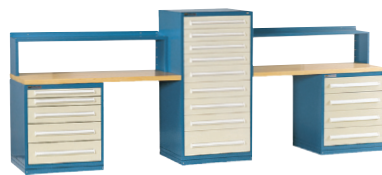

D-11: 1-SEP3155AL, 1-SEP1023AL, 1-SEP1031AL, 2-HT60, 2-BFS60, 2-HILO



D-12: 1-SEP3155AL, 1-SEP1023AL, 1-SEP1031AL, 2-HT60, 2-BFS60, 2-BPBFS60, ES330, 2-HILO

OPEN BENCH LEGS

- Formed steel leg units predrilled for fastening

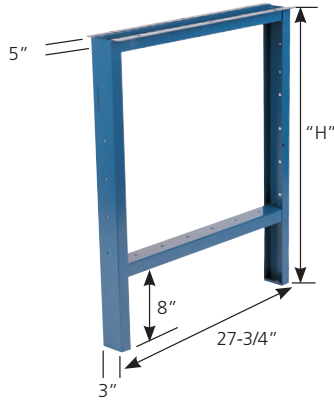

Open Bench Legs

| MODEL # | DESCRIPTION | HEIGHT | |
|---------|------------------------------------|--------|----------|
| | | IN. | MM |
| BL1351 | For 135 Cab. with Pallet Feet | 26.85" | (682mm) |
| BL1352 | For 135 Cab. with HNF | 24.72" | (628mm) |
| BL1353 | For 135 Cab. with RB | 29.85" | (758mm) |
| BL1354 | For 135 Cab. with RB and HNF | 27.72" | (704mm) |
| BL1355 | For 135 Cab. with Channel Base | 25.44" | (646mm) |
| BL1356 | For 135 Cab. with MB, Plate Caster | 28.45" | (723mm) |
| BL1551 | For 155 Cab. with Pallet Feet | 30.00" | (762mm) |
| BL1552* | For 155 Cab. with HNF | 27.87" | (708mm) |
| BL1553 | For 155 Cab. with RB | 33.00" | (838mm) |
| BL1554 | For 155 Cab. with RB and HNF | 30.84" | (783mm) |
| BL1555 | For 155 Cab. with Channel Base | 28.62" | (727mm) |
| BL1556 | For 155 Cab. with MB, Plate Caster | 28.60" | (726mm) |
| BL1751 | For 175 Cab. with Pallet Feet | 33.15" | (842mm) |
| BL1752 | For 175 Cab. with HNF | 31.02" | (788mm) |
| BL1753 | For 175 Cab. with RB | 36.15" | (918mm) |
| BL1754 | For 175 Cab. with RB and HNF | 34.02" | (864mm) |
| BL1755 | For 175 Cab. with Channel Base | 31.77" | (807mm) |
| BL1756 | For 175 Cab. with MB, Plate Caster | 31.75" | (806mm) |
| BL2001 | For 200 Cab. with Pallet Feet | 37.09" | (942mm) |
| BL2002 | For 200 Cab. with HNF | 34.95" | (888mm) |
| BL2003 | For 200 Cab. with RB | 40.09" | (1018mm) |
| BL2004 | For 200 Cab. with RB and HNF | 37.95" | (964mm) |
| BL2005 | For 200 Cab. with Channel Base | 35.68" | (906mm) |
| BL2451 | For 245 Cab. with Pallet Feet | 44.17" | (1122mm) |
| BL2452 | For 245 Cab. with HNF | 42.04" | (1068mm) |
| BL2453 | For 245 Cab. with RB | 47.17" | (1198mm) |
| BL2454 | For 245 Cab. with RB and HNF | 45.01" | (1143mm) |
| BL2455 | For 245 Cab. with Channel Base | 42.76" | (1086mm) |
| BL2456 | For 245 Cab. with MB, Plate Caster | 42.77" | (1086mm) |

PANEL BENCH LEGS

- Combination of open bench legs and panels

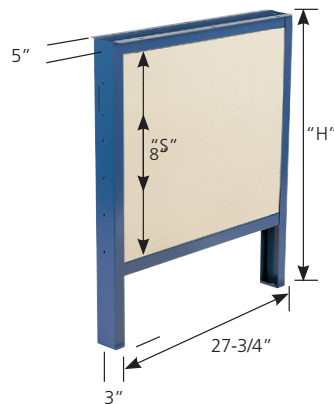

Panel Bench Legs

| MODEL # | DESCRIPTION | HEIGHT | |
|---------|-------------------------------|--------|----------|
| | | IN. | MM |
| PBL1351 | For 135 Cab. with Pallet Feet | 26.76" | (680mm) |
| PBL1353 | For 135 Cab. with RB | 29.76" | (756mm) |
| PBL1551 | For 155 Cab. with Pallet Feet | 29.91" | (760mm) |
| PBL1553 | For 155 Cab. with RB | 32.91" | (836mm) |
| PBL1751 | For 175 Cab. with Pallet Feet | 33.06" | (840mm) |
| PBL1753 | For 175 Cab. with RB | 36.06" | (916mm) |
| PBL2001 | For 200 Cab. with Pallet Feet | 37.00" | (940mm) |
| PBL2003 | For 200 Cab. with RB | 40.00" | (1016mm) |
| PBL2451 | For 245 Cab. with Pallet Feet | 44.08" | (1119mm) |
| PBL2453 | For 245 Cab. with RB | 47.08" | (1195mm) |

SIDE PANELS

- Can be easily installed into existing open bench legs

Side Panels

| MODEL # | DESCRIPTION | HEIGHT | |
|---------|--------------------------------|--------|---------|
| | | IN. | MM |
| BLSP16 | For use with BL1351 | 15.94" | (405mm) |
| BLSP19 | For use with BL1353 and BL1551 | 18.94" | (481mm) |
| BLSP22 | For use with BL1553 and BL1751 | 22.09" | (561mm) |
| BLSP25 | For use with BL1753 | 25.24" | (641mm) |
| BLSP28 | For use with BL2003 | 29.18" | (741mm) |
| BLSP33 | For use with BL2451 | 33.26" | (845mm) |
| BLSP36 | For use with BL2453 | 36.26" | (921mm) |

WORKSTATIONS & BENCHING: Stringers, Footrests & Footrest Shelves



STRINGER, FOOTREST, AND FOOTREST SHELVES

- Used between cabinets or between bench leg and cabinet
- Stringers and bench legs are predrilled



Stringer



Footrest



Footrest Shelf

Stringer

| MODEL # | DESCRIPTION | WORKSTATION TOP SIZES IN. (MM) | | | | | |
|---------|--------------------------------------|--------------------------------|--------------|--------------|--------------|--------------|---------------|
| | | 60" (1524MM) | 72" (1829MM) | 84" (2134MM) | 90" (2286MM) | 96" (2438MM) | 120" (3048MM) |
| STCCXXX | Std. Cabinet to Std. Cabinet | - | - | 24 | 30 | 36 | 60 |
| STBCXXX | Bench Leg to Std. Cabinet | 30 | 42 | 54 | 60 | 66 | 90 |
| STCCXXX | Sm. Version Cab. to Sm. Version Cab. | - | 27 | 39 | 45 | 51 | 75 |
| STBCXXX | Bench Leg to Sm. Version Cab. | 37 | 49 | 61 | 67 | 73 | 97 |
| STCCXXX | Std. Cabinet to Sm. Version Cab. | - | 19 | 31 | 37 | 43 | 67 |
| BLFRXX | Bench Leg to Bench Leg | 60 | 72 | 84 | 90 | 96 | 120 |

Not available on corner workstations

Footrest

| MODEL # | DESCRIPTION | WORKSTATION TOP SIZES IN. (MM) | | | | | |
|---------|--------------------------------------|--------------------------------|--------------|--------------|--------------|--------------|---------------|
| | | 60" (1524MM) | 72" (1829MM) | 84" (2134MM) | 90" (2286MM) | 96" (2438MM) | 120" (3048MM) |
| FRCCXXX | Std. Cabinet to Std. Cabinet | - | - | 024 | 030 | 036 | 060 |
| FRBCXXX | Bench Leg to Std. Cabinet | 030 | 042 | 054 | 060 | 066 | 090 |
| FRCCXXX | Sm. Version Cab. to Sm. Version Cab. | - | 027 | 039 | 045 | 051 | 075 |
| FRBCXXX | Bench Leg to Sm. Version Cab. | 037 | 049 | 061 | 067 | 073 | 097 |
| FRCCXXX | Std. Cabinet to Sm. Version Cab. | - | 019 | 031 | 037 | 043 | 097 |
| BLFRXX | Bench Leg to Bench Leg | 60 | 72 | 84 | 90 | 96 | 120 |

Not available on corner workstations

Footrest Shelf

| MODEL # | DESCRIPTION | WORKSTATION TOP SIZES IN. (MM) | | | | | |
|---------|--------------------------------------|--------------------------------|--------------|--------------|--------------|--------------|---------------|
| | | 60" (1524MM) | 72" (1829MM) | 84" (2134MM) | 90" (2286MM) | 96" (2438MM) | 120" (3048MM) |
| SHCCXXX | Std. Cabinet to Std. Cabinet | - | - | 024 | 030 | 036 | 060 |
| SHBCXXX | Bench Leg to Std. Cabinet | 030 | 042 | 054 | 060 | 066 | 090 |
| SHCCXXX | Sm. Version Cab. to Sm. Version Cab. | - | 027 | 039 | 045 | 051 | 075 |
| SHBCXXX | Bench Leg to Sm. Version Cab. | 037 | 049 | 061 | 067 | 073 | 097 |
| SHCCXXX | Std. Cabinet to Sm. Version Cab. | - | 019 | 031 | 037 | 043 | 067 |
| BLSXX | Bench Leg to Bench Leg | 60 | 72 | 84 | 90 | 96 | 120 |

Not available on corner workstations

MODESTY PANELS

- Vidmar® technical benching modesty panels are lightweight steel panels used to completely enclose benching rear
- Modesty panels are predrilled for fastening (support braces included)



Modesty Panels

| MODEL # | LENGTH | WORKSTATION TOP SIZE |
|--------------|--|----------------------|
| AU-28-043-47 | BL-CAB 43" (1092mm) W x 28" (711mm) H | 48" (1219mm) |
| AU-28-055-47 | BL-CAB 55" (1397mm) W x 28" (711mm) H | 60" (1524mm) |
| AU-28-067-47 | BL-CAB 67" (1701mm) W x 28" (711mm) H | 72" (1829mm) |
| AU-31-043-47 | BL-CAB 43" (1092mm) W x 31" (787mm) H | 48" (1219mm) |
| AU-31-055-47 | BL-CAB 55" (1397mm) W x 31" (787mm) H | 60" (1524mm) |
| AU-31-067-47 | BL-CAB 67" (1701mm) W x 31" (787mm) H | 72" (1829mm) |
| AU-35-043-47 | BL-CAB 43" (1092mm) W x 35" (889mm) H | 48" (1219mm) |
| AU-35-055-47 | BL-CAB 55" (1397mm) W x 35" (889mm) H | 60" (1524mm) |
| AU-35-067-47 | BL-CAB 67" (1701mm) W x 35" (889mm) H | 72" (1829mm) |
| AU-28-026-33 | CAB-CAB 26" (660mm) W x 28" (711mm) H | 48" (1219mm) |
| AU-28-038-33 | CAB-CAB 38" (965mm) W x 28" (711mm) H | 60" (1524mm) |
| AU-28-050-33 | CAB-CAB 50" (1270mm) W x 28" (711mm) H | 72" (1829mm) |
| AU-31-026-33 | CAB-CAB 26" (660mm) W x 31" (787mm) H | 48" (1219mm) |
| AU-31-038-33 | CAB-CAB 38" (965mm) W x 31" (787mm) H | 60" (1524mm) |
| AU-31-050-33 | CAB-CAB 50" (1270mm) W x 31" (787mm) H | 72" (1829mm) |
| AU-35-026-33 | CAB-CAB 26" (660mm) W x 35" (889mm) H | 48" (1219mm) |
| AU-35-038-33 | CAB-CAB 38" (965mm) W x 35" (889mm) H | 60" (1524mm) |
| AU-35-050-33 | CAB-CAB 50" (1270mm) W x 35" (889mm) H | 72" (1829mm) |

BACKSTOPS

- Flat steel panels used to enclose lower 3" (76mm) of rear of riser shelf
- Predrilled for fastening to riser shelf and bench top (same basic design as back panel, except only 3-3/4" [92mm] high)

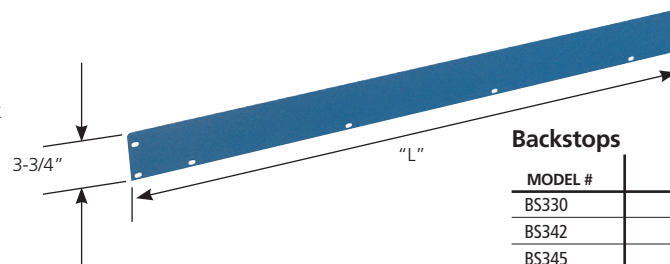

Backstops

| MODEL # | IN. | LENGTH MM |
|---------|------|-----------|
| BS330 | 30" | (762mm) |
| BS342 | 42" | (1067mm) |
| BS345 | 45" | (1143mm) |
| BS348 | 48" | (1219mm) |
| BS360 | 60" | (1524mm) |
| BS372 | 72" | (1829mm) |
| BS384 | 84" | (2134mm) |
| BS396 | 96" | (2438mm) |
| BS3120 | 120" | (3048mm) |

END STOPS

- Flat steel panels with rear portions formed and pierced for attachment to backstops and/or riser shelves
- Supplied in a pair for left and right ends of bench unit

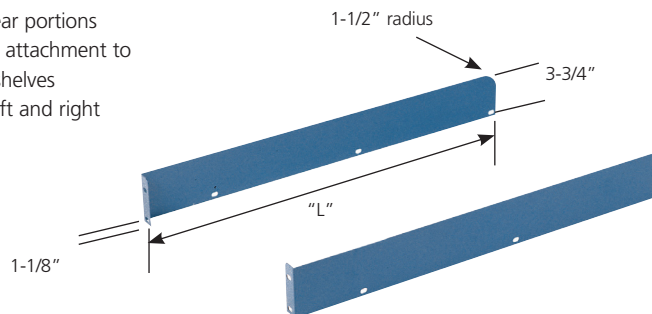

End Stops

| MODEL # | IN. | LENGTH MM |
|---------|---------|-----------|
| ES324 | 24" | (610mm) |
| ES328 | 27-3/4" | (705mm) |
| ES330 | 30" | (762mm) |
| ES336 | 36" | (914mm) |

WORKSTATIONS & BENCHING: Outlets & Lights

BENCH RISER SHELVES/ CORNER RISER SHELVES (A, B)

- Ideal for getting tools, test, and other equipment off work surface
- 12" (305mm) deep
- Available in fixed 14" (356mm) height or adjustable height from 12" to 22" (305mm to 559mm)

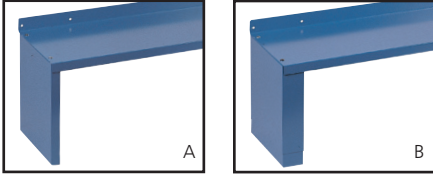

Fixed Height Bench Riser Shelves/Corner Riser Shelves (A)

| MODEL # | FIXED HEIGHT | SHELF MATERIAL | POWER | CORNER RISER MODEL # |
|--|---------------------------|--|-----------------------------------|----------------------|
| *BFS30, 36, 42, 48, 54, 60, 72, 84, 96 | 12" x 14" (305mm x 356mm) | Steel | See Electrical Outlet Strip Chart | CBFS30 |
| *BFH30, 36, 42, 48, 54, 60, 72, 84, 96 | 12" x 14" (305mm x 356mm) | Ash Hardwood (add 1-1/4" [32mm] to height) | — | CBFH30 |

*Note: To order back panels (fixed risers only), use BPFBS 30/36/42/48/54/60/72/84/96 for steel and hardwood shelves

Adjustable Height Bench Riser Shelves/Corner Riser Shelves (B)

| MODEL # | ADJUSTABLE HEIGHT | SHELF MATERIAL | POWER | CORNER RISER MODEL # |
|--|-------------------------------------|----------------|-----------------------------------|----------------------|
| *BAS30, 36, 42, 48, 54, 60, 72, 84, 96 | 12" x 12"-22" (305mm x 305mm-559mm) | Steel | See Electrical Outlet Strip Chart | CBAS30 |
| | See WAH below | Hardwood | See CWAH30 below | |

*Note: To order back panels (fixed risers only), use BPFBS 30/36/42/48/54/60/72/84/96 for steel and hardwood shelves

ELECTRICAL OUTLET STRIPS AND LIGHTS

- Attach to the face or rear of a bench riser, a work surface shelf, or to a backstop located at the rear of a worksurface
- Part numbers ending in P are available in silver gray, enamel finish, prewired with plug; part numbers not ending in P are beige (with wiring instructions)
- Prewired strips are less than 2" (51mm) square, have a 15 amp circuit breaker, a snap-clip mounting system, and are UL-listed and CSA Certified*
- Fluorescent lights are available in lengths of 18", 36" and 48"

Notes: Power to workstation should be wired through GFCI receptacle. Factory installation not available for electrical outlet strips.

* Bench accessories are not predrilled for electrical outlet strips

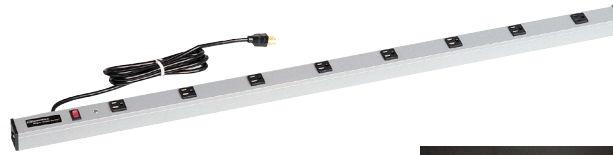

Electrical Outlet Strips and Lights

| MODEL # | # OF OUTLETS | LENGTH | |
|--------------------------|--------------|--------|----------|
| | | IN. | MM |
| Electrical Outlet Strips | | | |
| EOS09P | 4 | 9" | (229mm) |
| EOS24P | 8 | 24" | (610mm) |
| EOS48P | 8 | 48" | (1219mm) |
| EOS72P | 9 | 72" | (1829mm) |
| EOS36 | 6 | 36" | (914mm) |
| EOS60 | 5 | 60" | (1524mm) |
| EOS72 | 6 | 72" | (1829mm) |
| Lights | | | |
| FL01807200 | | 18" | (457mm) |
| FL03607200 | | 36" | (914mm) |
| FL04807200 | | 48" | (1219mm) |

WORKSTATION RISER SHELVES/CORNER RISER SHELVES (C, D)

- Available in fixed 15" (381mm) height or adjustable height from 12" to 22" (305mm to 559mm)
- Power (110V) can be supplied to workstation through uprights, shelves, or both (options below)
- 12" (305mm) deep



Power support shown

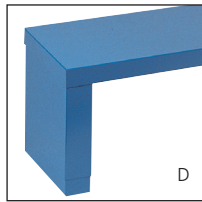

Non-power support shown

Fixed Height Workstation Riser Shelves/Corner Riser Shelves (C)

| MODEL # | FIXED HEIGHT | SHELF MATERIAL | POWER | CORNER RISER MODEL # |
|---|---------------------------|----------------|--------------------------------|----------------------|
| *WFS30, 36, 42, 48, 54, 60, 72, 84, 96 | 12" x 15" (305mm x 381mm) | Steel | None | CWFS30 |
| *WFS30P, 36P, 42P, 48P, 54P, 60P, 72P, 84P, 96P | 12" x 15" (305mm x 381mm) | Steel | Shelf and Supports (with GFCI) | CWFS30 |
| *WFH30, 36, 42, 48, 54, 60, 72, 84, 96 | 12" x 15" (305mm x 381mm) | Hardwood | None | CWFH30 |
| *WFH30P, 36P, 42P, 48P, 54P, 60P, 72P, 84P, 96P | 12" x 15" (305mm x 381mm) | Hardwood | Supports Only (with GFCI) | CWFH30 |

*Note: To order back panels (fixed risers only), use BPWFS 30/36/42/48/54/60/72/84/96 for steel surfaces, and BPWFC 30/36/42/48/54/60/72/84/96 for hardwood surfaces

Adjustable Height Workstation Riser Shelves/Corner Riser Shelves (D)

| MODEL # | ADJUSTABLE HEIGHT | SHELF MATERIAL | POWER | CORNER RISER MODEL # |
|--|-------------------------------------|-------------------------------------|--|----------------------|
| WAS30, 36, 42, 48, 54, 60, 72, 84, 96 | 12" x 12"-22" (305mm x 305mm-559mm) | Steel | None | CWAS30 |
| WAS30P, 36P, 42P, 48P, 54P, 60P, 72P, 84P, 96P | 12" x 12"-22" (305mm x 305mm-559mm) | Steel | Shelf Only (with GFCI) | CWAS30 |
| WAH30, 36, 42, 48, 54, 60, 72, 84, 96 | 12" x 12"-22" (305mm x 305mm-559mm) | Hardwood (add 1/4" [6mm] to height) | See Electrical Outlet Strip Chart If Power Is Required | CWAH30 |

BACK PANELS (A, B)

- Formed steel panel used to completely enclose rear of riser shelf
- Predrilled for fastening to riser shelf and bench top
- Support braces supplied with riser shelf are not used when optional back panel is utilized

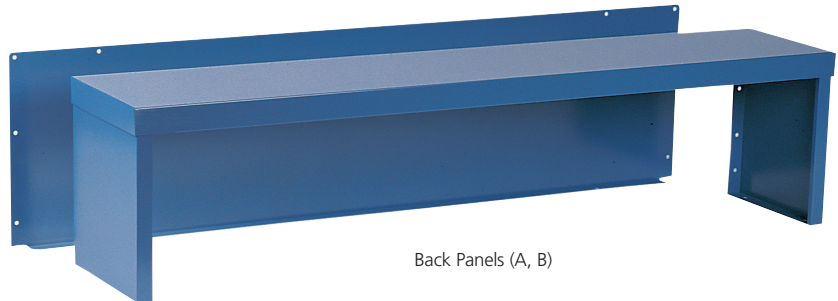

Back Panels (A, B)

Back Panels: Fixed Bench Risers (A) (Use with BFS Risers)

| MODEL # | DESCRIPTION | LENGTH | |
|---------|----------------|--------|----------|
| | | IN. | MM |
| BPBFS30 | Fixed Steel | 30" | (762mm) |
| BPBFS36 | Fixed Steel | 36" | (914mm) |
| BPBFS42 | Fixed Steel | 42" | (1067mm) |
| BPBFS48 | Fixed Steel | 48" | (1219mm) |
| BPBFS54 | Fixed Steel | 54" | (1372mm) |
| BPBFS60 | Fixed Steel | 60" | (1524mm) |
| BPBFS72 | Fixed Steel | 72" | (1829mm) |
| BPBFS84 | Fixed Steel | 84" | (2134mm) |
| BPBFS96 | Fixed Steel | 96" | (2438mm) |
| BPBFS30 | Fixed Hardwood | 30" | (762mm) |
| BPBFS36 | Fixed Hardwood | 36" | (914mm) |
| BPBFS42 | Fixed Hardwood | 42" | (1067mm) |
| BPBFS48 | Fixed Hardwood | 48" | (1219mm) |
| BPBFS54 | Fixed Hardwood | 54" | (1372mm) |
| BPBFS60 | Fixed Hardwood | 60" | (1524mm) |
| BPBFS72 | Fixed Hardwood | 72" | (1829mm) |
| BPBFS84 | Fixed Hardwood | 84" | (2134mm) |
| BPBFS96 | Fixed Hardwood | 96" | (2438mm) |

Back Panels: Workstation Risers (B)

| MODEL # | DESCRIPTION | LENGTH | |
|-----------|----------------|--------|----------|
| | | IN. | MM |
| BPWFS30 | Fixed Steel | 30" | (762mm) |
| BPWFS36 | Fixed Steel | 36" | (914mm) |
| BPWFS42 | Fixed Steel | 42" | (1067mm) |
| BPWFS48 | Fixed Steel | 48" | (1219mm) |
| BPWFS54 | Fixed Steel | 54" | (1372mm) |
| BPWFS60 | Fixed Steel | 60" | (1524mm) |
| BPWFS72 | Fixed Steel | 72" | (1829mm) |
| BPWFS84 | Fixed Steel | 84" | (2134mm) |
| BPWFS96 | Fixed Steel | 96" | (2438mm) |
| BPWFCXX30 | Fixed Hardwood | 30" | (762mm) |
| BPWFCXX36 | Fixed Hardwood | 36" | (914mm) |
| BPWFCXX42 | Fixed Hardwood | 42" | (1067mm) |
| BPWFCXX48 | Fixed Hardwood | 48" | (1219mm) |
| BPWFCXX54 | Fixed Hardwood | 54" | (1372mm) |
| BPWFCXX60 | Fixed Hardwood | 60" | (1524mm) |
| BPWFCXX72 | Fixed Hardwood | 72" | (1829mm) |
| BPWFCXX84 | Fixed Hardwood | 84" | (2134mm) |
| BPWFCXX96 | Fixed Hardwood | 96" | (2438mm) |

WORKSTATIONS & BENCHING: Work Surfaces

SPLICE KITS (NOT PICTURED)

Model # SP

28" (711mm) long

- Includes predrilled metal plate and attaching hardware
- Used when joining two tops to form a corner workstation

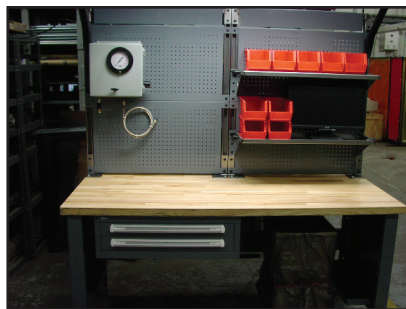

HI-LO MOUNTING KIT (NOT PICTURED)

Model# HILO

- Includes a painted predrilled bracket and hardware
- Used for mounting a worksurface to the side of a cabinet



WORK SURFACES



Note: Other sizes available

DESCRIPTION,
IN. (MM)

CONSTRUCTION

APPLICATION

SPANS
IN. (MM)

30" (762MM) DEEP (FRONT TO BACK) WORK SURFACES

1-1/2" (38mm) Thick, Plastic Top

Laminate top over particle board core

Light-duty benching applications

72" (1829mm)

1-1/2" (38mm) Thick, Radius-Edge Plastic Top

Laminate top over particle board core

Light-duty benching applications

72" (1829mm)

1-3/4" (44mm) Thick, Shop Top

High-density resin core with particle board surface

Heavy-duty workbench applications

72" (1829mm)

1-3/4" (44mm) Thick, Steel Top

Painted steel top with enclosed ends

Heavy-duty workbench

96" (2438mm)

1-3/4" (44mm) Thick, Hardwood Top

Solid, hardwood

Heavy-duty

96" (2438mm)

27-3/4" (705MM) DEEP CABINET COVERS

3/8" (22mm) Stainless Steel Surface

Fits over cabinet

Cabinet cover

none

7/8" (22mm) Stainless Steel Surface to Fit Over MLPT

Fits over particle board

Cabinet cover

none

1/4" (6mm) Steel Plate Top

Fits over any surface, painted

Cabinet cover, heavy-duty

none

1/8" (3mm) Steel Plate Top

Fits over any surface, painted

Cabinet cover, heavy-duty

none

OTHER TOPS

1-3/4" (44mm) Thick, 36" (914mm) Deep, Full Radius, Dissipative Top

Laminate over particle board

StaticGard™ applications

60" (1524mm)

1-3/4" (44mm) Thick, 30" (762mm) Deep Stainless Steel Surface to Fit Over Hardwood Top

Formed stainless steel

Cabinet cover

none

1-1/2" (38mm) Thick, 30" (762mm) and 36" (914mm) Deep Stainless Top, 1/4" (6mm) Radius Edge on Four Sides

Stainless steel surface, premium MDF core with melamine backing

Heavy-duty workbench applications

72" (1829mm)

WORKSTATIONS & BENCHING: Work Surfaces



Customize your workstation with accessories

MODEL # — TOP LENGTHS, IN. (MM)

| 30" (762MM) | 45" (1143MM) | 48" (1219MM) | 60" (1524MM) | 72" (1829MM) | 84" (2134MM) | 90" (2286MM) | 96" (2438MM) | 120" (3048MM) |
|------------------------------|------------------------------|------------------------------|------------------------------|------------------------------|------------------------------|------------------------------|------------------------------|--------------------------------|
| PL30 | PL45 | — | PL60 | PL72 | PL84 | PL90 | PL96 | — |
| — | — | — | PLR60 | PLR72 | PLR84 | PLR90 | PLR96 | — |
| WT30 | WT45 | — | WT60 | WT72 | WT84 | WT90 | WT96 | — |
| ST30 | ST45 | — | ST60 | ST72 | ST84 | ST90 | ST96 | — |
| HT30 | HT45 | — | HT60 | HT72 | HT84 | HT90 | HT96 | HT120 |
| CT-27-030-30 | CT-27-045-30 | — | CT-27-060-30 | — | — | CT-27-090-30 | — | CT-27-120-30 |
| SIS30 | SIS45 | — | SIS60 | SIS72 | SIS84 | SIS90 | SIS96 | SIS120 |
| SPT014 | — | — | SPT024 | — | — | — | — | — |
| SPT018 | — | — | SPT028 | — | — | — | — | — |
| — | — | — | SGWS60361 | SGWS72361 | SGWS84361 | SGWS90361 | SGWS96361 | — |
| SIS30M | SIS45M | — | SIS60M | SIS72M | SIS84M | SIS90M | SIS96M | — |
| SS-30X30X150 SS-36X30X150 | SS-45X30X150 SS-45X36X150 | SS-48X30X150 SS-48X36X150 | SS-60X30X150 SS-60X36X150 | SS-72X30X150 SS-72X36X150 | SS-84X30X150 SS-84X36X150 | SS-90X30X150 SS-90X36X150 | SS-96X30X150 SS-96X36X150 | SS-120X30X150 SS-120X36X150 |

*Quick Ship products

BOOKCASE

- Standard bookcase is 30" (762mm) wide—the dimensions of a standard cabinet—and 14" (356mm) deep
- Bookcases are also available in 45" (1143mm) and 60" (1524mm) widths
- Secured bookcase options available
- Shelves are adjustable on 2" Centers

LOCK FOR HINGED DOORS

Model # SDLBKAXX

Replace XX with desired height:

- 17" (432mm), 27" (684mm),
30" (762mm), 33" (838mm),
37" (940mm) and 44" (1118mm)



Bookcase

| MODEL # | DESCRIPTION | HEIGHT | # OF SHELVES |
|---------|--------------------------|--------|--------------|
| BKA44 | Standard – 30" W x 14" D | 44" | 2 |
| BKA37 | Standard – 30" W x 14" D | 37" | 1 |
| BKA33 | Standard – 30" W x 14" D | 33" | 1 |
| BKA30 | Standard – 30" w x 14" D | 30" | 1 |
| BKA27 | Standard – 30" w x 14" D | 27" | 1 |
| BKA17 | Standard – 30" w x 14" D | 17" | None |

*Add prefix of "XW" for 45" wide bookcase or "DW" for 60" wide bookcase (i.e., XWBA44: etc.)

* Small Version (SV) bookcase is available, add SV in front of the bookcase model #

Bookcase Options

| MODEL # | DESCRIPTION | BATTENS | DOUBLE-HINGED STEEL DOORS | BYPASSING CLEAR PLASTIC | BYPASSING STEEL |
|----------|----------------------|---------|------------------------------|----------------------------|--------------------|
| BKAXX* | Standard | BT300 | SDBKAXX | PSBKAXX | SSBKAXX |
| XWBKAXX* | Extra-Wide | BTXW300 | N/A | N/A | N/A |
| DWBKAXX* | Double-Wide | BTDW300 | N/A | N/A | N/A |
| BS30 | Bookcase Shelf – 30" | — | — | — | — |
| BS45 | Bookcase Shelf – 45" | — | — | — | — |
| BS60 | Bookcase Shelf – 60" | — | — | — | — |
| MLPT30 | Laminated Top – 30" | — | — | — | — |
| MLPT45 | Laminated Top – 45" | — | — | — | — |
| MLPT60 | Laminated Top – 60" | — | — | — | — |

*Substitute height (44, 37, 33, 30, 27, 17) for "XX" in model number

BOOKCASE RISER

- Specially made to support bookcases



Bookcase Riser

| MODEL # | DESCRIPTION | HEIGHT | | LENGTH | | APPLICATION |
|---------|-------------|--------|---------|--------|----------|--|
| | | IN. | MM | IN. | MM | |
| BKR3014 | Riser | 14" | (356mm) | 30" | (762mm) | One Standard Width Bookcase |
| BKR3021 | Riser | 21" | (533mm) | 30" | (762mm) | One Standard Width Bookcase |
| BKR3024 | Riser | 24" | (610mm) | 30" | (762mm) | One Standard Width Bookcase |
| BKR4514 | Riser | 14" | (356mm) | 45" | (1143mm) | One Extra-Wide Bookcase |
| BKR4521 | Riser | 21" | (533mm) | 45" | (1143mm) | One Extra-Wide Bookcase |
| BKR4524 | Riser | 24" | (610mm) | 45" | (1143mm) | One Extra-Wide Bookcase |
| BKR6014 | Riser | 14" | (356mm) | 60" | (1524mm) | One Double-Wide or Two Standard Bookcases |
| BKR6021 | Riser | 21" | (533mm) | 60" | (1524mm) | One Double-Wide or Two Standard Bookcases |
| BKR6024 | Riser | 24" | (610mm) | 60" | (1524mm) | One Double-Wide or Two Standard Bookcases |
| BKR9014 | Riser | 14" | (356mm) | 90" | (2286mm) | Three Standard, Two Extra-Wide, or One Double-Wide and One Standard Bookcase |
| BKR9021 | Riser | 21" | (533mm) | 90" | (2286mm) | Three Standard, Two Extra-Wide, or One Double-Wide and One Standard Bookcase |
| BKR9024 | Riser | 24" | (610mm) | 90" | (2286mm) | Three Standard, Two Extra-Wide, or One Double-Wide and One Standard Bookcase |

WORKSTATIONS & BENCHING: Under-Bench Cabinets

UNDER-BENCH PRECONFIGURED CABINETS

Available in six footprints:

1. Standard - 30" W x 27-3/4" D (UB0040, UB0060, UB0090, UB0110)
2. Shallow Depth - 30" W x 21-3/8" D (LWUB0040, LWUB0060, LWUB0090, LWUB0110)
3. Small Version - 22-1/2" W x 27-3/4" D (SVUB0040, SVUB0060, SVUB0090, SVUB0110)
4. Extra-Wide - 45" W x 27-3/4" D (XWUB0040, XWUB0060, XWUB0090, XWUB0110)
5. Extra-Wide Shallow Depth - 45" W x 21-3/8" D (XLUB0040, XLUB0060, XLUB0090, XLUB0110)
6. Double-Wide - 60" W x 27-3/4" D (DWUB0040, DWUB0060, DWUB0090, DWUB0110)

- Ideal for suspending from hardwood work surfaces
- Provides same durable storage capabilities as full-size Vidmar® cabinets
- Under-Bench cabinets allow for same drawer modularity as conventional cabinets (total drawer "points" must equal cabinet model number)



Under-Bench Preconfigured Cabinets

| MODEL # | # & TYPE OF DRAWERS | CABINET HEIGHT | |
|------------|---------------------|----------------|---------|
| | | IN. | MM |
| UB40202 | 2 of #20 | 9-3/4" | (248mm) |
| UB40401 | 1 of #40 | 9-3/4" | (248mm) |
| UB60203 | 3 of #20 | 12-7/8" | (372mm) |
| UB60302 | 2 of #30 | 12-7/8" | (372mm) |
| UB60201401 | 1 of #20, 1 of #40 | 12-7/8" | (372mm) |
| UB60601 | 1 of #60 | — | — |

| HOUSING MODEL | HEIGHT |
|---------------|-----------------|
| 40 | 9-3/4" (248mm) |
| 60 | 12-7/8" (372mm) |
| 90 | 17-5/8" (448mm) |
| 110 | 20-3/4" (527mm) |

CABINETS

- The cabinet is the cornerstone of a Vidmar® technical bench
- All cabinets have flush fronts and recessed drawer pulls
- All cabinets have a 16-1/2" (419mm) W x 28-1/4" (717mm) D footprint
- Three heights are available: 27-7/8" (711mm); 31" (787mm) and 35" (899mm) to meet your individual ergonomic needs
- Cabinet doors are also available with adjustable cabinet shelves



27-7/8" (711MM) DESK HEIGHT PRECONFIGURED CABINETS

PSTB28008 Model 8

Desk Height

27-7/8" (711mm) H
16-1/2" (419mm) W
28-1/4" (717mm) D



TB2801A
4 Drawers
28 Compartments
Usable Drawer Height
2-3/4" (69mm)
5-7/8" (149mm)
12-3/16" (309mm)



TB2802A
4 Drawers
24 Compartments
Usable Drawer Height
2-3/4" (69mm)
5-7/8" (149mm)
9" (229mm)



TB2803A
6 Drawers
44 Compartments
Usable Drawer Height
2-3/4" (69mm)
5-7/8" (149mm)



TB2805A
2 Drawers
Usable Drawer Height
12-3/16" (309mm)



TB2806A
4 Drawers
20 Compartments
Usable Drawer Height
5-7/8" (149mm)



TB2807A
1 Drawer
4 Compartments
1 Door (Right Hinge Shown)
1 Bottom Pan
Usable Drawer Height
5-7/8" (149mm)



TB2804A
3 Drawers
12 Compartments
Usable Drawer Height
5-7/8" (149mm)
12-3/16" (309mm)



TB2808A
1 Shelf and
1 Door (Right Hinge Shown)
1 Bottom Pan

WORKSTATIONS & BENCHING: Technical Bench Cabinets



31" (787MM) TABLE HEIGHT PRECONFIGURED CABINETS

PSTB31009
MODEL 9

TABLE HEIGHT
31" (787mm) H
16-1/2" (419mm) W
28-1/4" (717mm) D



TB3101A
5 Drawers
32 Compartments
Usable Drawer Height
2-3/4" (69mm)
5-7/8" (149mm)
12-3/16" (309mm)



TB3102A
5 Drawers
38 Compartments
Usable Drawer Height
2-3/4" (69mm)
5-7/8" (149mm)



TB3103A
5 Drawers
32 Compartments
Usable Drawer Height
2-3/4" (69mm)
5-7/8" (149mm)
9" (229mm)



TB3104A
1 Drawer
4 Compartments
1 Shelf and 1 Door (Right Hinge Shown)
1 Bottom Pan
Usable Drawer Height
5-7/8" (149mm)



TB3105A
3 Drawers
4 Compartments
Usable Drawer Height
2-3/4" (69mm)
12-3/16" (309mm)

35" (889MM) BENCH HEIGHT PRECONFIGURED CABINETS

PSTB350010
MODEL 10

BENCH HEIGHT
35" (889mm) H
16-1/2" (419mm) W
28-1/4" (717mm) D



TB3501A
5 Drawers
32 Compartments
Usable Drawer Height
5-7/8" (149mm)



TB3502A
3 Drawers
4 Compartments
Usable Drawer Height
5-7/8" (149mm)
12-3/16" (309mm)



TB3503A
5 Drawers
26 Compartments
Usable Drawer Height
2-3/4" (69mm)
5-7/8" (149mm)
9" (229mm)



TB3504A
1 Drawer
4 Compartments
1 Shelf and 1 Door (Right Hinge Shown)
1 Bottom Pan
Usable Drawer Height
5-7/8" (149mm)



TB3505A
6 Drawers
36 Compartments
Usable Drawer Height
5-7/8" (149mm)
9" (229mm)



**PSTB420012
Model 12**
Bench Height
42" (1.1m) H
16-1/2" (419mm) W
28-1/4" (717mm) D

TECHNICAL BENCH DRAWERS

- Each Vidmar® technical bench cabinet drawer carries a load capacity of 200 lbs.
- Each drawer has 1955cm² of storage space available in four drawer heights: 2-3/4" (69mm), 5-7/8" (149mm), 9" (229mm), and 12-3/16" (309mm)
- Each drawer is equipped with 200 lbs. rated ball bearing slides for smooth, quiet operation
- Each drawer can be divided with full-depth, Vidmar® partitions and dividers
- Five standard interior loading diagrams are available. Partitions and dividers are factory configured and installed
- The larger drawer unit (PSTB04) can hold file folders without additional hardware
- Recessed drawer pulls are designed to accept 1-1/4" (33mm) labels with 3/4" (19mm) font or common P-Touch® labels for easy readability

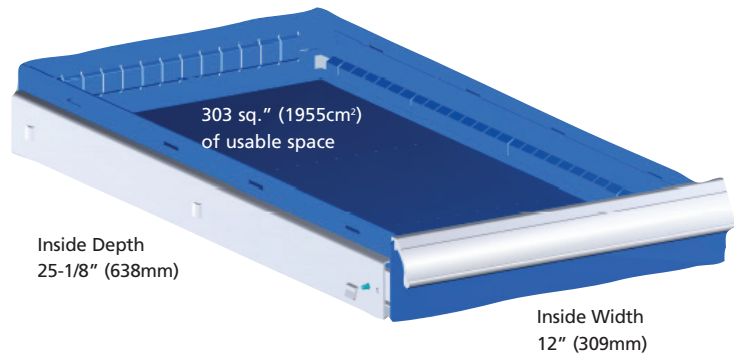

Drawers

| MODEL # | USABLE HEIGHT | | SIDE WALL HEIGHT | |
|---------|---------------|---------|------------------|---------|
| | IN. | MM | IN. | MM |
| PSTB01 | 2-3/4" | (69mm) | 2-5/8" | (66mm) |
| PSTB02 | 5-7/8" | (149mm) | 5" | (127mm) |
| PSTB03 | 9" | (229mm) | 8" | (203mm) |
| PSTB04 | 12-3/16" | (309mm) | 9-1/2" | (241mm) |

DRAWER HEIGHT

- Each drawer has 303 sq in. (1955 cm²) of usable space 25-1/8" (638mm) inside depth x 12" (309mm) inside width
- Drawer selection by model number must add up to the cabinet height



LDPSTB88
8 Compartments
(4) 5-1/2" x 6-1/4"
(140mm x 159mm)
(4) 6-1/4" x 6-1/4"
(159mm x 159mm)



LDPSTB510
9 Compartments
(6) 4" x 8-5/8"
(102mm x 219mm)
(3) 4" x 7-7/8"
(102mm x 200mm)



LDPSTB810
6 Compartments
(2) 5-1/2" x 8-5/8"
(140mm x 219mm)
(1) 5-1/2" x 7-7/8"
(140mm x 200mm)
(2) 6-1/4" x 8-5/8"
(159mm x 219mm)
(1) 6-1/4" x 7-7/8"
(159mm x 200mm)



LDPSTB58
12 Compartments
(12) 4" x 6-1/4"
(102mm x 159mm)



LDPSTB816
4 Compartments
(2) 5-1/2" x 12-1/2"
(140mm x 318mm)
(2) 6-1/4" x 12-1/2"
(159mm x 318mm)

WORKSTATIONS & BENCHING: Technical Bench



RECESSED BASES & BASE EXTENSIONS

- Vidmar® technical benching recessed bases (3" H) and base extensions (2" H) provide employees with additional toe space



Base Extensions

| MODEL # | DESCRIPTION | HEIGHT |
|---------|----------------------------|------------|
| PSTBKP1 | Stainless Steel Kick Plate | 7" (177mm) |
| PSTBRB1 | Recessed Base | 3" (76mm) |
| PSTNRB1 | Base Extension | 2" (50mm) |

ADDITIONAL TECHNICAL BENCHING ACCESSORIES

- Includes lock kits, mobile caster kits, bottom shelves, bottom pans, and right-hand-only and left-hand-only cabinet doors



Additional Accessories

| MODEL # | DESCRIPTION | HEIGHT |
|----------|-----------------------------|---------------|
| SL10TB | Lock Kit | |
| MB2HRTBS | 2" (51mm) Mobile Castor Kit | 3-1/4" (83mm) |
| PSTBCS20 | 200 lbs. Bottom Shelf | — |
| PSTBBP20 | 200 lbs. Bottom Pan | — |

Doors

| MODEL # | DESCRIPTION | HEIGHT |
|----------|--------------------|-----------------|
| PSTBSD06 | LH or RH Door Only | 19" (480mm) |
| PSTBSD07 | LH or RH Door Only | 22" (560mm) |
| PSTBSD08 | LH or RH Door Only | 25-1/4" (640mm) |
| PSTBSD09 | LH or RH Door Only | 28-3/8" (720mm) |
| PSTBSD10 | LH or RH Door Only | 31-1/2" (800mm) |
| PSTBSD12 | LH or RH Door Only | 42" (1067mm) |

VIDMAR® WORKBENCH ACCESSORY SYSTEM FEATURES

Vidmar Workbench Accessory System benefits include:

- Greater productivity and efficiency
- Reduced strain, increased ergonomic ease
- Workstations equipped to exactly suit your needs
- Properly illuminated work area
- Maximum available worksurface



WORKSTATIONS & BENCHING: Nexus

SYSTEM FRAMES

- Building your ideal Vidmar® workbench accessory system is an easy process
- Simply select the frames (starters and adders) that fit your worksurface width, then pick accessories of corresponding widths to mount on the frames
- Accessories are easily moved and repositioned as your needs change

Surface-Mount Frames

- Frames are sturdy, made of heavy-gauge steel, and are notched front and back at 1" increments for mounting accessories
- Starter frames consist of 2 upright posts and a horizontal rail
- Adder section consist of an additional upright and horizontal rail. Uprights are available in heights of 30" and 48", and 6 widths
- Foot plate is 2 3/4" x 4"
- Specify color from chart on back cover

30" High Surface-Mount Frames

| MODEL NO. | SEC. WIDTH CENTER-TO-CENTER |
|--------------------|--------------------------------|
| STARTER SET | |
| V-NXF/SM2430 | 24" |
| V-NXF/SM3030 | 30" |
| V-NXF/SM3630 | 36" |
| V-NXF/SM4230 | 42" |
| V-NXF/SM4830 | 48" |
| V-NXF/SM6030 | 60" |

| | |
|------------------|-----|
| ADDER SET | |
| V-NXF/SM2430A | 24" |
| V-NXF/SM3030A | 30" |
| V-NXF/SM3630A | 36" |
| V-NXF/SM4230A | 42" |
| V-NXF/SM4830A | 48" |
| V-NXF/SM6030A | 60" |

48" High Surface-Mount Frames

| MODEL NO. | SEC. WIDTH CENTER-TO-CENTER |
|--------------------|--------------------------------|
| STARTER SET | |
| V-NXF/SM2448 | 24" |
| V-NXF/SM3048 | 30" |
| V-NXF/SM3648 | 36" |
| V-NXF/SM4248 | 42" |
| V-NXF/SM4848 | 48" |
| V-NXF/SM6048 | 60" |

| | |
|------------------|-----|
| ADDER SET | |
| V-NXF/SM2448A | 24" |
| V-NXF/SM3048A | 30" |
| V-NXF/SM3648A | 36" |
| V-NXF/SM4248A | 42" |
| V-NXF/SM4848A | 48" |
| V-NXF/SM6048A | 60" |

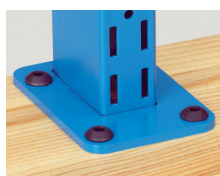
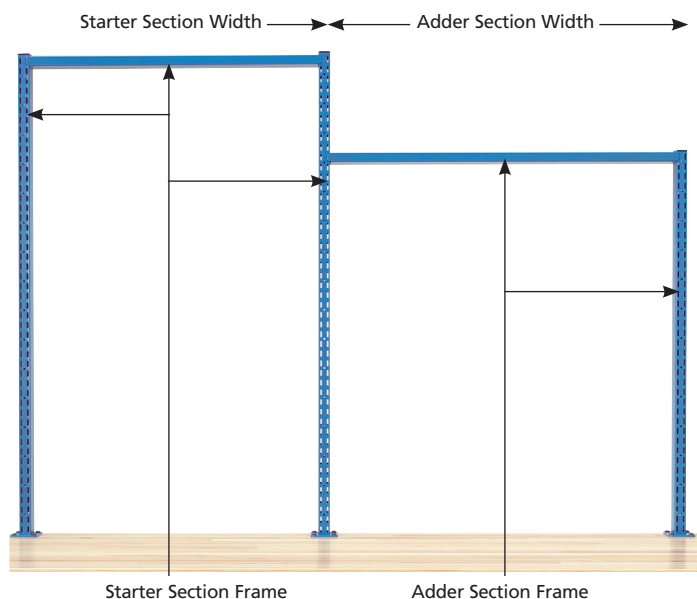

Available Widths of Frame Systems

The widths below represent measurements from frame center to frame center. Uprights are 1 3/16" wide.

Using 1 Section

| SECTION WIDTH (CENTER-TO-CENTER) | OVERALL WIDTH (FOOT-TO-FOOT) | MINIMUM WORK- SURFACE LENGTH | INSIDE USEABLE WIDTH |
|-------------------------------------|---------------------------------|---------------------------------|-------------------------|
| 24" | 26 3/4" | 30" | 22 3/4" |
| 30" | 32 3/4" | 36" | 28 3/4" |
| 36" | 38 3/4" | 42" | 34 3/4" |
| 42" | 44 3/4" | 48" | 40 3/4" |
| 48" | 50 3/4" | 54" | 46 3/4" |
| 60" | 62 3/4" | 66" | 58 3/4" |

Using 1 Starter and 1 Adder Section

| SECTION WIDTH (CENTER-TO-CENTER) | OVERALL WIDTH | MINIMUM WORKSURFACE LENGTH (FOOT-TO-FOOT) |
|-------------------------------------|---------------|--|
| 24" + 24" | 50 3/4" | 54" |
| 24" + 30" | 56 3/4" | 60" |
| 24" + 36" | 62 3/4" | 66" |
| 24" + 42" | 68 3/4" | 72" |
| 24" + 48" | 74 3/4" | 78" |
| 24" + 60" | 86 3/4" | 90" |
| 30" + 30" | 62 3/4" | 66" |
| 30" + 36" | 68 3/4" | 72" |
| 30" + 42" | 74 3/4" | 78" |
| 30" + 48" | 80 3/4" | 84" |
| 30" + 60" | 92 3/4" | 96" |
| 36" + 36" | 74 3/4" | 78" |
| 36" + 42" | 80 3/4" | 84" |
| 36" + 48" | 86 3/4" | 90" |
| 36" + 60" | 98 3/4" | 102" |
| 42" + 42" | 86 3/4" | 90" |
| 42" + 48" | 92 3/4" | 96" |
| 42" + 60" | 104 3/4" | 108" |
| 48" + 48" | 98 3/4" | 102" |
| 48" + 60" | 110 3/4" | 114" |
| 60" + 60" | 122 3/4" | 126" |

SHELVES

Adjustable Shelves

- Adjustable, heavy-gauge steel shelves can be mounted parallel to the worksurface or at a 15° angle for easy, ergonomic access
- Shelves have a 100 lb. weight capacity for evenly distributed loads
- Shelves are reversible, with the lip either at the front, or at the rear to act as a back stop

Shelf Dividers

- Steel dividers fit over the edge of adjustable shelf when shelf is mounted at 0°
- Base of divider can be either to left or right of divider upright
- Painted to match shelf

Adjustable Shelves Without Lip

- Adjustable steel shelf has a 100 lb. weight capacity
- Supports are attached through a simple double-notch system that insert into slots on the uprights
- Available in depths of 12" and 15"
- Prepunched holes accept vertical wire dividers (see below)

Vertical Wire Dividers for Adjustable Shelves Without Lip

- Dividers are 1/4" diameter galvanized wire that fit into prepunched holes in the shelf
- No hardware required
- Depth must match shelf depth



Adjustable Shelves

| MODEL NO. | SHELF WID. | SEC. WID. |
|-----------------|------------|-----------|
| 12" DEEP | | |
| V-NXS/A2412L | 23 1/2" | 24" |
| V-NXS/A3012L | 29 1/2" | 30" |
| V-NXS/A3612L | 35 1/2" | 36" |
| V-NXS/A4212L | 41 1/2" | 42" |
| V-NXS/A4812L | 47 1/2" | 48" |
| V-NXS/A6012L | 59 1/2" | 60" |
| 15" DEEP | | |
| V-NXS/A2415L | 23 1/2" | 24" |
| V-NXS/A3015L | 29 1/2" | 30" |
| V-NXS/A3615L | 35 1/2" | 36" |
| V-NXS/A4215L | 41 1/2" | 42" |
| V-NXS/A4815L | 47 1/2" | 48" |
| V-NXS/A6015L | 59 1/2" | 60" |



Adjustable Shelves Without Lip

| MODEL NO. | SHELF WIDTH |
|-----------------|-------------|
| 12" DEEP | |
| V-NXS/A2412D | 24" |
| V-NXS/A3012D | 30" |
| V-NXS/A3612D | 36" |
| V-NXS/A4212D | 42" |
| V-NXS/A4812D | 48" |
| V-NXS/A6012D | 60" |
| 15" DEEP | |
| V-NXS/A2415D | 24" |
| V-NXS/A3015D | 30" |
| V-NXS/A3615D | 36" |
| V-NXS/A4215D | 42" |
| V-NXS/A4815D | 48" |
| V-NXS/A6015D | 60" |

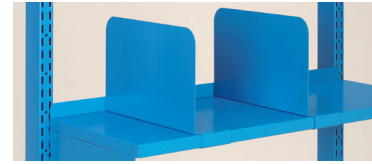

Shelf Dividers

| MODEL NO. | HEIGHT |
|--|--------|
| FOR 12" DEEP ADJUSTABLE SHELVES | |
| V-NXS/MD100-12/L | 4" |
| V-NXS/MD100-12/R | 4" |
| V-NXS/MD150-12/L | 6" |
| V-NXS/MD150-12/R | 6" |
| V-NXS/MD200-12/L | 8" |
| V-NXS/MD200-12/R | 8" |
| FOR 15" DEEP ADJUSTABLE SHELVES | |
| V-NXS/MD100-15/L | 4" |
| V-NXS/MD100-15/R | 4" |
| V-NXS/MD150-15/L | 6" |
| V-NXS/MD150-15/R | 6" |
| V-NXS/MD200-15/L | 8" |
| V-NXS/MD200-15/R | 8" |

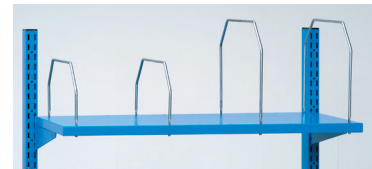

Vertical Wire Dividers for Adjustable Shelves Without Lip

| MODEL NO. | HEIGHT |
|-----------------------------|--------|
| FOR 12" DEEP SHELVES | |
| V-NXS/WD150-12 | 6" |
| V-NXS/WD250-12 | 10" |
| V-NXS/WD450-12 | 18" |
| FOR 15" DEEP SHELVES | |
| V-NXS/WD150-15 | 6" |
| V-NXS/WD250-15 | 10" |
| V-NXS/WD450-15 | 18" |

WORKSTATIONS & BENCHING: Nexus



SHELVES

Variable Angle Shelves

- Shelf adjusts from totally flat to a 25° angle and has a capacity of 150 lbs. for evenly distributed loads
- Can be mounted in a forward or set-back position between uprights for maximum flexibility



Variable Angle Shelves

MODEL NO. SHELF WID. SEC. WIDTH

18" DEEP

| | | |
|--------------|---------|-----|
| V-NXS/V2418L | 22 1/2" | 24" |
| V-NXS/V3018L | 28 1/2" | 30" |
| V-NXS/V3618L | 34 1/2" | 36" |
| V-NXS/V4218L | 40 1/2" | 42" |
| V-NXS/V4818L | 46 1/2" | 48" |
| V-NXS/V6018L | 58 1/2" | 60" |

24" DEEP

| | | |
|--------------|---------|-----|
| V-NXS/V2424L | 22 1/2" | 24" |
| V-NXS/V3024L | 28 1/2" | 30" |
| V-NXS/V3624L | 34 1/2" | 36" |
| V-NXS/V4224L | 40 1/2" | 42" |
| V-NXS/V4824L | 46 1/2" | 48" |

Variable Angle Shelves Without Lip

- Shelves are 18" or 24" deep with a 150 lb. weight capacity
- Can be mounted in a forward or set-back position between uprights for maximum flexibility
- Prepunched holes accept vertical wire dividers (see below)

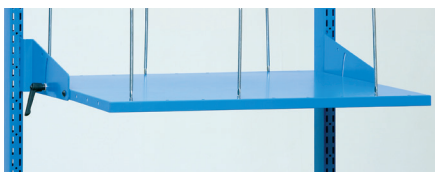

Variable Angle Shelves Without Lip

MODEL NO. SHELF WIDTH

18" DEEP

| | |
|--------------|-----|
| V-NXS/V2418D | 24" |
| V-NXS/V3018D | 30" |
| V-NXS/V3618D | 36" |
| V-NXS/V4218D | 42" |
| V-NXS/V4818D | 48" |
| V-NXS/V6018D | 60" |

24" DEEP

| | |
|--------------|-----|
| V-NXS/V2424D | 24" |
| V-NXS/V3024D | 30" |
| V-NXS/V3624D | 36" |
| V-NXS/V4224D | 42" |
| V-NXS/V4824D | 48" |

Vertical Wire Dividers for Deep Shelves

Without Lip

- Dividers are 1/4" diameter galvanized wire that fit into prepunched holes in the shelf
- No hardware required
- Depth must match shelf depth



Vertical Wire Dividers for Deep Shelves Without Lip

MODEL NO. HEIGHT

FOR 18" DEEP SHELVES

| | |
|----------------|-----|
| V-NXS/WD150-18 | 6" |
| V-NXS/WD250-18 | 10" |
| V-NXS/WD450-18 | 18" |

FOR 24" DEEP SHELVES

| | |
|----------------|-----|
| V-NXS/WD150-24 | 6" |
| V-NXS/WD250-24 | 10" |
| V-NXS/WD450-24 | 18" |

LIGHTING ACCESSORIES

Overhead Light Fixtures

- Fluorescent fixture is available in 2-bulb or 4-bulb model in 44" or 56" length
- Tilts up or down 10°
- Brackets allow light fixture to be mounted to frame sections 30" to 90" wide
- Kit includes switch and 8' grounded electrical cord, support track, standard acrylic diffuser and T8 bulbs. Requires V-NX/OHL-TR/BRK support brackets (See right).
- Fixture available in Light Gray only, but brackets can be ordered in any color
- Bracket with fixture can also simultaneously support tool rail



Overhead Light Fixture Kits

| MODEL NO. | FIXTURE WIDTH | SECTION WIDTH |
|----------------|---------------|---------------|
| 2-BULB | | |
| V-NX/OHL-R48/2 | 44" | 30"-48" |
| V-NX/OHL-R60/2 | 56" | 49"-60" |
| V-NX/OHL-R72/2 | 56" | 61"-72" |
| V-NX/OHL-R78/2 | 56" | 73"-78" |
| V-NX/OHL-R84/2 | 56" | 79"-84" |
| V-NX/OHL-R90/2 | 56" | 85"-90" |

| MODEL NO. | FIXTURE WIDTH | SECTION WIDTH |
|----------------|---------------|---------------|
| 4-BULB | | |
| V-NX/OHL-R48/4 | 44" | 30"-48" |
| V-NX/OHL-R60/4 | 56" | 49"-60" |
| V-NX/OHL-R72/4 | 56" | 61"-72" |
| V-NX/OHL-R78/4 | 56" | 73"-78" |
| V-NX/OHL-R84/4 | 56" | 79"-84" |
| V-NX/OHL-R90/4 | 56" | 85"-90" |

Overhead Light and Tool Rail Support Brackets

Required for mounting overhead light fixture. Brackets come in pairs. Specify color (See back cover for color chart).

- 24" deep brackets used with a 24" or 30" deep worksurface
- 30" deep brackets used with a 30" or 36" deep worksurface

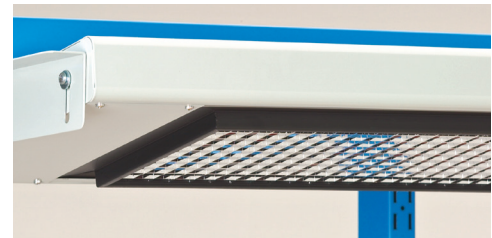

Overhead Light and Tool Rail Support Brackets

| MODEL NO. | BRACKET DEPTH |
|-------------------|---------------|
| V-NX/OHL-TR/BRK24 | 24" |
| V-NX/OHL-TR/BRK30 | 30" |

Parabolic Diffusers for Light Fixture

- Optional chrome-plated plastic parabolic grid directs light onto worksurface while eliminating glare on adjacent workstations

Overhead Light Fixtures Only

| MODEL NO. | BULBS | WIDTH |
|--------------|-------|-------|
| V-NX/OHL44/2 | 2 | 44" |
| V-NX/OHL44/4 | 4 | 44" |
| V-NX/OHL56/2 | 2 | 56" |
| V-NX/OHL56/4 | 4 | 56" |

Parabolic Diffusers for Light Fixture

| MODEL NO. | USE WITH |
|---------------|-------------------|
| V-NX/OHL-PD44 | 44" light fixture |
| V-NX/OHL-PD56 | 56" light fixture |

Undershelf Task Lights

- Attaches by magnet under shelves or overhead cabinets. Includes white acrylic wrap-around diffuser, switch, 6' cord and bulb



Undershelf Task Lights

| MODEL NO. | SIZE | BULB |
|-----------|-----------------------|--------|
| V-FLF-18 | 18" W x 5" D x 1 3/4" | HF15T8 |



WORKSTATIONS & BENCHING: Nexus

TOOL RAILS AND POWER OPTIONS

Tool Rails

- The tool rail spans the length of the worksurface
- Available in 48", 60" or 72" lengths
- Each tool rail has a 30 lb. capacity, and comes complete with a trolley, 2 hangers, 2 endstops, and 2 end caps in black finish
- Balancer not included. Requires support brackets
- Fixture and bracket can also simultaneously support overhead light
- Color is Black

Swing Arm Tool Rail

- The swing arm tool rail is 36" in length and swings 180°
- It has a 30 lb. capacity and includes a trolley, 1 endstop, and 1 end cap
- Includes mounting bracket
- Balancer not included
- Color is Black

Single Uprights

- Economical solution to mounting power or articulating component above the worksurface
- Capacity 60 lbs.

Airhose Attachment

- Small bracket attaches to frame upright
- Quick-connect fitting not supplied

Vertical Power Strips

- Mounts vertically to front and back of upright
- Bracket and hardware supplied
- Lighted on/off switch, 6' cord with grounded plug and circuit breaker are included
- Fixture and brackets are Black

Horizontal Power Rails

- Self-contained, 6-plug electrical outlet strip
- Power rail pivots on axis, providing full horizontal adjustability
- 110V, 15 amp or 20 amp circuit breaker



Tool Rails

| MODEL NO. | LENGTH |
|-----------|--------|
| V-TR48 | 48" |
| V-TR60 | 60" |
| V-TR72 | 72" |



Swing Arm Tool Rail

| MODEL NO. | LENGTH |
|-----------|--------|
| V-SWT36 | 36" |



Single Uprights

| MODEL NO. | HEIGHT |
|--------------|--------|
| V-NXF-P30/SM | 30" |
| V-NXF-P48/SM | 48" |

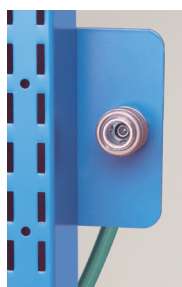

Airhose Attachment

| MODEL NO. | DESCRIPTION |
|-----------|------------------------|
| V-NX/AHB | Bracket for air supply |



Vertical Power Strips

| MODEL NO. | DESCRIPTION |
|--------------|-------------------------|
| V-NXVPS/15 | 15 amp with 6 outlets |
| V-NXVPS/20 | 20 amp with 6 outlets |
| V-NXVPS/15GF | 15 amp GFCI w/6 outlets |
| V-NXVPS/20GF | 20 amp GFCI w/6 outlets |

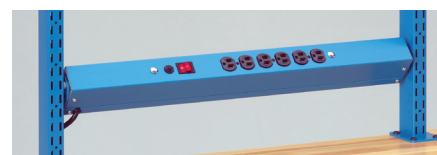

Horizontal Power Rails

| MODEL NO. 15 AMP | MODEL NO. 20 AMP |
|---------------------|---------------------|
| V-NXHPS/24-15 | V-NXHPS/24-20 |
| V-NXHPS/30-15 | V-NXHPS/30-20 |
| V-NXHPS/36-15 | V-NXHPS/36-20 |
| V-NXHPS/42-15 | V-NXHPS/42-20 |
| V-NXHPS/48-15 | V-NXHPS/48-20 |
| V-NXHPS/60-15 | V-NXHPS/60-20 |
| 15 AMP GFCI | 20 AMP GFCI |
| V-NXHPS/24-15GF | V-NXHPS/24-20GF |
| V-NXHPS/30-15GF | V-NXHPS/30-20GF |
| V-NXHPS/36-15GF | V-NXHPS/36-20GF |
| V-NXHPS/42-15GF | V-NXHPS/42-20GF |
| V-NXHPS/48-15GF | V-NXHPS/48-20GF |
| V-NXHPS/60-15GF | V-NXHPS/60-20GF |

PLASTIC BOX RAILS, BACK STOPS AND ROLL HOLDERS

Plastic Box Rails

- The plastic box rail is easily adjustable for ergonomic access
- It can be mounted parallel to the worksurface or at a 15° angle
- The rail is attached via a simple double-notch system
- It can hold boxes that have hanger lips at the rear for attaching to a louvered panel
- Plastic boxes not included
- Must match the width of your chosen section frame
- Specify color from chart on page 164

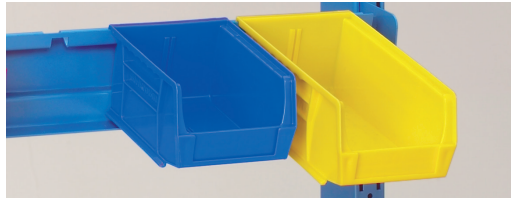

Plastic Box Rails

| MODEL NO. | WIDTH | MAXIMUM # OF 3" BOXES/RAIL |
|-----------|-------|----------------------------|
| V-NXBR/24 | 24" | 7 |
| V-NXBR/30 | 30" | 9 |
| V-NXBR/36 | 36" | 11 |
| V-NXBR/42 | 42" | 13 |
| V-NXBR/48 | 48" | 15 |
| V-NXBR/60 | 60" | 19 |

Back Stops

- Prevents items from rolling off worksurface, 3" in height
- Painted to match frame. Must match the width of your chosen section frame
- Specify color from chart on page 164



Back Stops

| MODEL NO. | USE WITH SECTION WIDTH |
|-----------|------------------------|
| V-NXBS/24 | 24" |
| V-NXBS/30 | 30" |
| V-NXBS/36 | 36" |
| V-NXBS/42 | 42" |
| V-NXBS/48 | 48" |
| V-NXBS/60 | 60" |

Roll Holders

(Extended Mount)

- For dispensing paper, bubble rolls, etc. Includes 1" diameter rod and brackets
- Brackets mount to uprights and extend 3" forward from the face of the uprights to allow for larger diameter rolls
- Rod is unpainted galvanized steel; brackets are painted to match frame
- 100 lb. weight capacity



Roll Holders

(Extended Mount)

| MODEL NO. | USE WITH SEC. WIDTH | USB. INSIDE WIDTH |
|------------|---------------------|-------------------|
| V-NXRH/E24 | 24" | 22" |
| V-NXRH/E30 | 30" | 28" |
| V-NXRH/E36 | 36" | 34" |
| V-NXRH/E42 | 42" | 40" |
| V-NXRH/E48 | 48" | 46" |
| V-NXRH/E60 | 60" | 58" |

Label/Roll Holders

(Interior Mount)

- For dispensing labels and other smaller rolls
- Brackets mount flush between uprights. Includes 1" diameter rod and brackets
- Rod is unpainted galvanized steel; brackets are painted to match frame
- 100 lb. weight capacity



Label/Roll Holders

(Interior Mount)

| MODEL NO. | USE WITH SEC. WIDTH | USB. INSIDE WIDTH |
|------------|---------------------|-------------------|
| V-NXRH/C24 | 24" | 22" |
| V-NXRH/C30 | 30" | 28" |
| V-NXRH/C36 | 36" | 34" |
| V-NXRH/C42 | 42" | 40" |
| V-NXRH/C48 | 48" | 46" |
| V-NXRH/C60 | 60" | 58" |

WORKSTATIONS & BENCHING: Nexus



OVERHEAD CABINETS

- Overhead cabinets can attach to a system frame for protected, secure above-worksurface storage of large, bulky items
- Available without doors, or with a choice of door options
- Note: Mounting brackets must be ordered separately (See add-on accessories below)



Overhead cabinet with recessed door

| MODEL NO. | DESCRIPTION | DIMENSIONS W X D X H |
|---------------|---------------------------------------|----------------------|
| ATOS24190005 | 24" Overhead / Housing Only | 24" x 15" x 19" |
| ATOS30190005 | 30" Overhead / Housing Only | 30" x 15" x 19" |
| ATOS36190005 | 36" Overhead / Housing Only | 36" x 15" x 19" |
| ATOS48190005 | 48" Overhead / Housing Only | 48" x 15" x 19" |
| ATOS24190005R | 24" Overhead Cabinet / Recessed Doors | 24" x 15" x 19" |
| ATOS30190005R | 30" Overhead Cabinet / Recessed Doors | 30" x 15" x 19" |
| ATOS36190005R | 36" Overhead Cabinet / Recessed Doors | 36" x 15" x 19" |
| ATOS48190005R | 48" Overhead Cabinet / Recessed Doors | 48" x 15" x 19" |



Overhead cabinet with gas strut door

| MODEL NO. | DESCRIPTION | DIMENSIONS W X D X H |
|---------------|--|----------------------|
| ATOS24190005G | 24" Overhead Cabinet / Gas Strut Doors | 24" x 15" x 19" |
| ATOS30190005G | 30" Overhead Cabinet / Gas Strut Doors | 30" x 15" x 19" |
| ATOS36190005G | 36" Overhead Cabinet / Gas Strut Doors | 36" x 15" x 19" |
| ATOS48190005G | 48" Overhead Cabinet / Gas Strut Doors | 48" x 15" x 19" |

ADD-ON ACCESSORIES:

| MODEL NO. | DESCRIPTION | DIMENSIONS W X D X H |
|-----------------|---------------------------------------|----------------------|
| ATOS2BP24 | 24" Overhead Cabinet Back Cover Panel | 24" L x 19" H |
| ATOSBP30 | 30" Overhead Cabinet Back Cover Panel | 30" L x 19" H |
| ATOSBP36 | 36" Overhead Cabinet Back Cover Panel | 36" L x 19" H |
| ATOSBP48 | 48" Overhead Cabinet Back Cover Panel | 48" L x 19" H |
| ATSLT24 | 24" Sloped Top | 24" x 15" x 7 1/4" |
| ATSLT30 | 30" Sloped Top | 30" x 15" x 7 1/4" |
| ATSLT36 | 36" Sloped Top | 36" x 15" x 7 1/4" |
| ATSLT48 | 48" Sloped Top | 48" x 15" x 7 1/4" |
| CYLSEC5 | Overhead Lock For Housings With Doors | — |
| V-NX/OHC-BRK16* | Cabinet Rear Mounting Bracket (Pair) | — |

*Note: must have bracket to mount overhead cabinets to Nexus frame

PANELS AND MARKERBOARD/TACKBOARDS

Louvered Panels

- Steel louvered panel is designed to accommodate industry-standard plastic boxes that feature louvered edge or lip

Pegboard Panels

- Steel pegboard panel accepts all standard pegging devices (i.e. hooks, etc.)
- Pegboard holes are 1/4" in diameter
- Ideal for placement of commonly used tools

Solid Privacy Panels

- Steel privacy panel encloses a section and can also be used to hold/display items with magnets

Reversible Markerboard/Tackboards

- Two-sided reversible board
- Features white magnetic markerboard on one side and gray fabric tackboard on the other
- Also functions as privacy panel and sound dampener
- 30" high

Louvered Panels

| MODEL NO. | USE WITH SECTION WIDTH |
|-----------------|------------------------|
| 18" HIGH | |
| V-NXLP/2418 | 24" |
| V-NXLP/3018 | 30" |
| V-NXLP/3618 | 36" |
| V-NXLP/4218 | 42" |
| V-NXLP/4818 | 48" |
| V-NXLP/6018 | 60" |
| 30" HIGH | |
| V-NXLP/2430 | 24" |
| V-NXLP/3030 | 30" |
| V-NXLP/3630 | 36" |
| V-NXLP/4230 | 42" |
| V-NXLP/4830 | 48" |
| V-NXLP/6030 | 60" |

Solid Privacy Panels

| MODEL NO. | USE WITH SECTION WIDTH |
|-----------------|------------------------|
| 18" HIGH | |
| V-NXSP/2418 | 24" |
| V-NXSP/3018 | 30" |
| V-NXSP/3618 | 36" |
| V-NXSP/4218 | 42" |
| V-NXSP/4818 | 48" |
| V-NXSP/6018 | 60" |
| 30" HIGH | |
| V-NXSP/2430 | 24" |
| V-NXSP/3030 | 30" |
| V-NXSP/3630 | 36" |
| V-NXSP/4230 | 42" |
| V-NXSP/4830 | 48" |
| V-NXSP/6030 | 60" |



Pegboard Panels

| MODEL NO. | USE WITH SECTION WIDTH |
|-----------------|------------------------|
| 18" HIGH | |
| V-NXPP/2418 | 24" |
| V-NXPP/3018 | 30" |
| V-NXPP/3618 | 36" |
| V-NXPP/4218 | 42" |
| V-NXPP/4818 | 48" |
| V-NXPP/6018 | 60" |
| 30" HIGH | |
| V-NXPP/2430 | 24" |
| V-NXPP/3030 | 30" |
| V-NXPP/3630 | 36" |
| V-NXPP/4230 | 42" |
| V-NXPP/4830 | 48" |
| V-NXPP/6030 | 60" |



Reversible Markerboard/Tackboards

| MODEL NO. | USE WITH SEC. WIDTH |
|--------------|---------------------|
| V-NXRMT/2430 | 24" |
| V-NXRMT/3030 | 30" |
| V-NXRMT/3630 | 36" |
| V-NXRMT/4230 | 42" |
| V-NXRMT/4830 | 48" |

WORKSTATIONS & BENCHING: Nexus



PIVOTING ACCESSORIES

Document Holder

- For displaying papers, plans, etc.
- 11 7/8" wide x 13 3/4" high
- Includes lip for pencils, pens, etc.



Document Holder

| MODEL NO. | DESCRIPTION |
|-----------|-----------------|
| V-NXA/DH | Document Holder |

Large Document Holder

- For displaying large documents, and open binders and books
- 23 5/8" wide x 13 3/4" high
- Includes lip for pencils, pens, etc.



Large Document Holder

| MODEL NO. | DESCRIPTION |
|-----------|-----------------------|
| V-NXA/DHW | Large Document Holder |

Bin Container

- Holds 3 rows of plastic bins for easy access to parts and components
- Interior space per shelf is 20" wide x 6" deep
- Top shelf is 3 1/4" high, second and third shelves are 3 3/4" high
- Requires accessory shelf for support (not included), or can be freestanding
- Does not include bin boxes
- 50 lb. capacity



Bin Container

| MODEL NO. | DESCRIPTION |
|------------|---------------|
| V-NX/AS-BC | Bin Container |

Equipment Shelf

- Holds a variety of customer-supplied equipment or tools
- 12 3/8" wide x 12 3/8" deep
- 75 lb. capacity



Equipment Shelf

| MODEL NO. | DESCRIPTION |
|-----------|-----------------|
| V-NX/AVS | Equipment Shelf |

PIVOTING ACCESSORIES

Accessory Shelf

- For easy access to small tools, instruments, parts, etc
- Ribbed rubber mat optional
- 21 1/4" wide x 7 3/8" deep
- 75 lb. capacity



Accessory Shelf

| MODEL NO. | DESCRIPTION |
|-------------|-------------------|
| V-NXA/VAS | shelf |
| V-NX/AS-MAT | ribbed rubber mat |

Flat Panel Monitor Arm

- For attaching flat panel monitor to upright
- Accepts both 75mm and 100mm square monitor hole patterns
- Includes bracket
- 17 1/2 lb. capacity

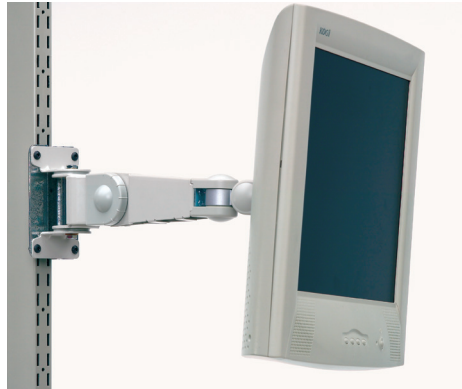

Flat Panel Monitor Arm

| MODEL NO. | DESCRIPTION |
|------------|------------------------|
| V-NXA/FPMA | Flat Panel Monitor Arm |

Flat Panel Monitor Arm

- Articulates horizontally
- Factory pretensioned articulated head and joints
- Mounts to column
- Maximum reach 16"
- Supports up to 18 lbs.

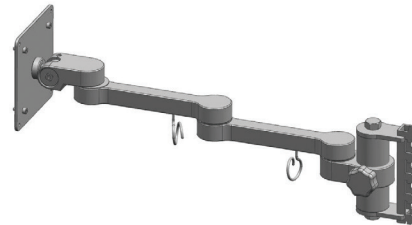

Flat Panel Monitor Arm

| MODEL NO. | DESCRIPTION |
|-----------|------------------------|
| V-4037 | Flat Panel Monitor Arm |



PIVOTING ACCESSORIES

Dual Flat Panel Monitor Arm

- Articulates horizontally
- Factory pretensioned articulated head and joints
- Mounts to column
- Maximum reach 16"
- Supports up to 18 lbs. per arm

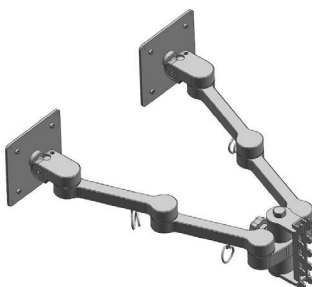

Dual Flat Panel Monitor Arm

| MODEL NO. | DESCRIPTION |
|-----------|-----------------------------|
| V-4045 | Dual Flat Panel Monitor Arm |

Full Function Flat Panel Monitor Arm

- Six lockable positions for arm and Vesa plate
- Articulates horizontally and vertical
- Factory pretensioned articulated head
- Mounts to column
- 12" height adjustment
- Maximum reach 15 7/8"
- Supports up to 26 lbs.

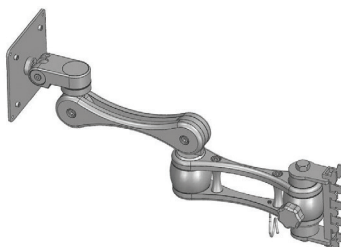

Full Function Flat Panel Monitor Arm

| MODEL NO. | DESCRIPTION |
|-----------|--------------------------------------|
| V-4036 | Full Function Flat Panel Monitor Arm |

New Gas Assist Tablet Monitor Arm

- Gas assist for easy, fluid movement
- Articulates horizontally and vertically
- Factory pre-tensioned articulating head
- Mounts to Arlink® 8000 and Nexus uprights
- Secure tablet holder
- Maximum reach 16.7" (424mm)
- Supports up to 5 lbs. (2.3kg)

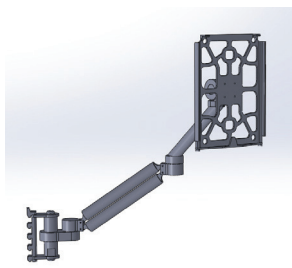

New Gas Assist Tablet Monitor Arm

| MODEL NO. | DESCRIPTION |
|-----------|---|
| 4047 | Gas Assist tablet arm: Secured iPad 2, 3 & 4 Holder; Column Mount (Weight 6 lbs.) |
| 4057 | Gas Assist tablet arm: Secured iPad Air Holder; Column Mount (Weight 6 lbs.) |

FLAT PANEL MONITOR ARMS

Vidmar is introducing a new, expanded offering of flat panel monitor arms, selected for its high quality and functionality. The goal of this expanded offering is to have a functional, affordable product in two competitive price points.

Features

- Made from 70% recycled material (green credits)
- Milled from 60-61 T6 aircraft grade, billet aluminum
- Arm finish: anodized
- Column bracket finish: available in Light Gray and Sand
- Manufactured in North America
- New bracket takes up less vertical column space (5")
- More mounting options
- Limited lifetime warranty
- FOB: Factory

The new arms will be available in three styles:

- Basic arm with left to right articulation—post and column mount available
- Full function arm with left to right and vertical articulation—post and column mount available
- Cross beam for multiple monitors

Monitor Mounting Rails and Mounting Knuckles

- Allows multiple monitors on multiple levels
- Clamp mount knuckle can be positioned to any horizontal position
- 5" knuckles allow tilt and angle adjustment
- Vesa 75/100 interface plate
- Rail locks into Arlink 8000 and Nexus micro slots
- Each rail includes 1 monitor mounting knuckle
- Specify additional knuckles as required
- Monitor size will dictate number of monitors that can be accommodated per rail
- Some assembly required
- Mounts to Arlink 8000 and Nexus uprights

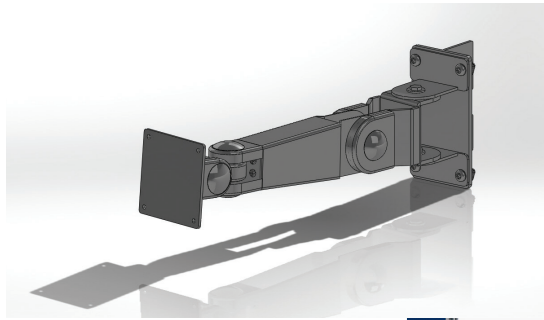

| Flat Panel Monitor Arms | |
|-------------------------|------------------------------|
| PART NO. | DESCRIPTION |
| 8415 | attaches to column |
| 8628 | includes 9" bracket extender |

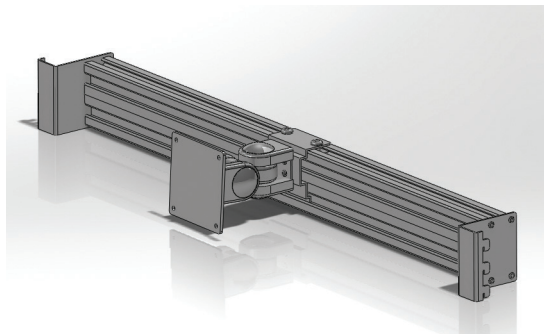

| Monitor Mounting Rails | | |
|------------------------|--------------------------|---------|
| PART NO. | DESCRIPTION | WEIGHT |
| 4070 | 30" Rail with 1 Knuckle | 12 lbs. |
| 4071 | 36" Rail with 1 Knuckle | 13 lbs. |
| 4072 | 48" Rail with 1 Knuckle | 15 lbs. |
| 4073 | 60" Rail with 1 Knuckle | 17 lbs. |
| 4074 | 72" Rail with 1 Knuckle | 19 lbs. |
| 4075 | Monitor Knuckle for Rail | 2 lbs. |



BASIC FLAT PANEL MONITOR ARMS

Basic monitor arm is either column mount or post mount, with left to right articulation. Has a 16" reach, with single or double arm options.

4037 – Basic Flat Panel Monitor Arm: Horizontal Articulation; Column Mount

- Articulates horizontally
- Factory pretensioned articulated head
- Factory pretensioned joints
- Vesa 75/100 interface plate
- Supports up to 18 lbs. (8kg)
- Maximum reach 16" (407mm)
- Mounts to Arlink 8000 and Nexus uprights

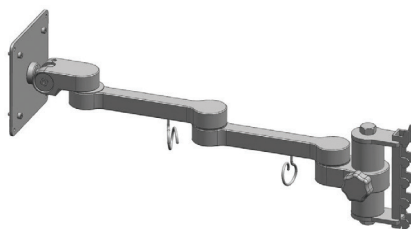

Basic Flat Panel Monitor Arm

| PART NO. | DESCRIPTION | WEIGHT |
|----------|--|--------|
| 4037 | Basic Flat Panel Monitor Arm, Column Mount | 6 lbs. |

4045 – Basic Dual Flat Panel Monitor Arm: Horizontal Articulation; Column Mount

- Articulates horizontally
- Factory pretensioned articulated head
- Factory pretensioned joints
- Vesa 75/100 interface plate
- Supports up to 18 lbs. (8kg) per arm
- Maximum reach 16" (407mm)
- Mounts to Arlink 8000 and Nexus uprights

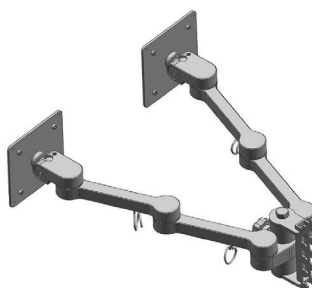

Basic Dual Flat Panel Monitor Arm

| PART NO. | DESCRIPTION | WEIGHT |
|----------|---|---------|
| 4045 | Basic Dual Flat Panel Monitor Arm, Column Mount | 12 lbs. |

4054 – Basic Flat Panel Monitor Arm: Horizontal Articulation; Post Mount

- Articulates horizontally
- Factory pretensioned articulated head
- Factory pretensioned joints
- Vesa 75/100 interface plate
- Supports up to 18 lbs. (8kg)
- Maximum reach 16" (407mm)
- Solid 1" diameter 13" high aluminum post
- Mounts through worksurface, hole diameter 1/2"

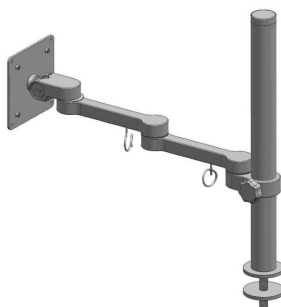

Basic Flat Panel Monitor Arm

| PART NO. | DESCRIPTION | WEIGHT |
|----------|--|--------|
| 4054 | Basic Flat Panel Monitor Arm, Post Mount | 6 lbs. |

4060 – Basic Dual Flat Panel Monitor Arm Arm: Horizontal Articulation; Post Mount

- Articulates horizontally
- Factory pretensioned articulated head
- Factory pretensioned joints
- Vesa 75/100 interface plate
- Supports up to 18 lbs. (8kg) per arm
- Maximum reach 16" (407mm)
- Solid 1" diameter 13" high aluminum post
- Mounts through worksurface, hole diameter 1/2"

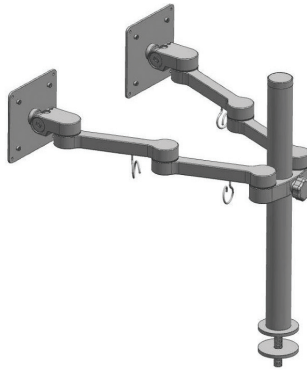

NEW FULL FUNCTION FLAT PANEL MONITOR ARMS

Full function monitor arm is either column mount or post mount, with left to right articulation and vertical angle adjustment. Has a 16" reach (optional 26"), with single or double arm options.

4036 – Full Function Flat Panel Monitor Arm: Vertical and Horizontal Articulation; Column Mount

- 6 lockable positions for arm and Vesa plate
- Articulates horizontally and vertically
- Factory pretensioned articulated head
- Vesa 75/100 interface plate
- Supports up to 26 lbs. (12kg)
- 12" height adjustment
- Maximum reach of 15.9" (404mm)
- Mounts to Arlink® 8000 and Nexus uprights

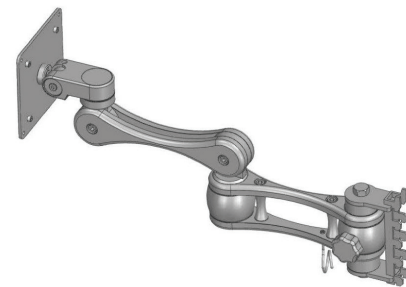

Full Function Flat Panel Monitor Arm

| PART NO. | DESCRIPTION | WEIGHT |
|----------|--|--------|
| 4036 | Full Function Flat Panel Monitor Arm, Column Mount | 8 lbs. |

4044 – Full Function Dual Flat Panel Monitor Arm: Vertical and Horizontal Articulation; Column Mount

- 6 lockable positions for arm and Vesa plate
- Articulates horizontally and vertically
- Factory pretensioned articulated head
- Vesa 75/100 interface plate
- Supports up to 26 lbs. (12kg) per arm
- 12" height adjustment
- Maximum reach of 15.9" (404mm)
- Mounts to Arlink® 8000 and Nexus uprights

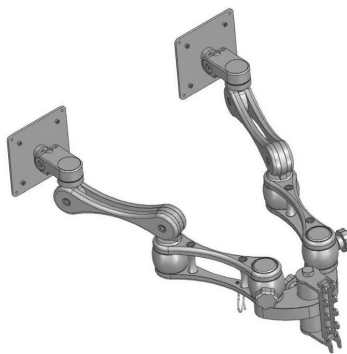

Full Function Dual Flat Panel Monitor Arm

| PART NO. | DESCRIPTION | WEIGHT |
|----------|---|---------|
| 4044 | Full Function Dual Flat Panel Monitor Arm, Column Mount | 16 lbs. |

WORKSTATIONS & BENCHING: Nexus



4053 – Full Function Flat Panel Monitor Arm: Vertical and Horizontal Articulation; Post Mount

- 6 lockable positions for arm and Vesa plate
- Articulates horizontally and vertically
- Factory pretensioned articulated head
- Vesa 75/100 interface plate
- Supports up to 26 lbs. (12kg)
- 12" height adjustment
- Maximum reach of 15.9" (404mm)
- Solid 1.5" diameter 15.75" high aluminum post
- Mounts through worksurface, hole diameter 1/2"



Full Function Flat Panel Monitor Arm

| PART NO. | DESCRIPTION | WEIGHT |
|----------|--|--------|
| 4053 | Full Function Flat Panel Monitor Arm, Post Mount | 8 lbs. |

4059 – Full Function Dual Flat Panel Monitor Arm: Vertical and Horizontal Articulation; Post Mount

- 6 lockable positions for arm and Vesa plate
- Articulates horizontally and vertically
- Factory pretensioned articulated head
- Vesa 75/100 interface plate
- Supports up to 26 lbs. (12kg) per arm
- 12" height adjustment
- Maximum reach of 15.9" (404mm)
- Solid 1.5" diameter 15.75" high aluminum post
- Mounts through worksurface, hole diameter 1/2"

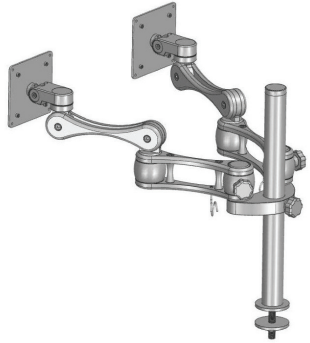

Full Function Dual Flat Panel Monitor Arm

| PART NO. | DESCRIPTION | WEIGHT |
|----------|---|---------|
| 4059 | Full Function Dual Flat Panel Monitor Arm, Post Mount | 16 lbs. |

FLAT PANEL MONITOR ARM ADDITIONAL OPTIONS

4063 – Full Function Extended Flat Panel Monitor Arm: Vertical and Horizontal Articulation; Column Mount, with 9 1/4" Extension

- 6 lockable positions for arm and Vesa plate
- Articulates horizontally and vertically
- Factory pretensioned articulated head
- Vesa 75/100 interface plate
- Supports up to 22 lbs. (10kg)
- 12" height adjustment
- Maximum reach of 25" (635mm)
- Mounts to Arlink® 8000 and Nexus uprights



Full Function Extended Flat Panel Monitor Arm

| PART NO. | DESCRIPTION | WEIGHT |
|----------|---|---------|
| 4063 | Full Function Extended Flat Panel Monitor Arm, Col. Mount | 10 lbs. |

SEATING

- Seating by Vidmar, the ultimate combination of down-and-dirty ruggedness and hour-after-hour comfort
- Built Vidmar-tough for performance that lasts and ergonomically designed to ensure proper body support
- Seating is available in an array of styles for specific job tasks

DELUXE INDUSTRIAL CHAIR

The most rugged, versatile seat in the line.

VCHRDLEXIND

Seat: 18.5" W x 18.5" D x 2" T
 Back: 16.5" W x 15.5" H x 2" T
 Base: 1.25" x 26" Dia., 11" H

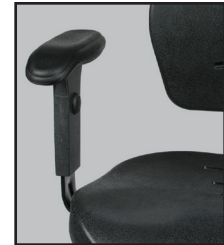

Seating available with or without casters and arm rests.
 Seating available in Black only.

PRODUCTION CHAIR

The ideal chair for repetitive work tasks.

VCHRPRODN

Seat: 18.5" W x 18.5" D x 2" T
 Back: 16.5" W x 15.5" H x 2" T
 Base: 25" Dia., 6" H



Production Chair

DELUXE ESD CHAIR

Vidmar toughness in a Electro-Static Dissipative (ESD)-protective work chair.

VCHRDLEXESD

Seat: 18.5" W x 18.5" D x 2" T
 Back: 16.5" W x 15.5" H x 2" T
 Base: 25" Dia., 6" H



Deluxe ESD Chair



Multi-Task Chair



ESD casters available

CHAIRS

SIT-STAND STOOL

Create the ultimate work environment for standing workers.

VSTLSITSTAND

Seat: 12" x 8" Oval
Base: 20" W x 16" D



Sit-Stand Stool

TOOL TROLLEY

Maximum comfort and convenience when working in a low position.

VSTLTROLLEY

Seat: 13" Dia.
Base: 20" Dia., 5.5" H



Tool Trolley



Glides optional



Multi-Purpose Stool

MULTI-PURPOSE STOOL

The one stool you need for a long list of jobs.

VSTLMPURP

Seat: 13" Dia.
Base: 24" Dia., 6" H



VIDMAR® ADJUSTABLE RACKING SYSTEM



Flexible. Heavy-Duty. Efficient.

The Adjustable Racking System is based on moveable pallets (instead of fixed shelves) that maximize every inch of your vertical storage space. Pallets can be continually adjusted or expanded to meet your changing storage needs.

- For use with existing forklift
- Removable, fully adjustable pallets that can change and grow with you
- Racking is available up to 16' high for maximum vertical storage space
- Systems can be broken up to fit around unavoidable building structures
- Array of convenient storage accessories



Adjustable Racking is a stand-alone storage system

VERTICAL STORAGE SOLUTIONS: Adjustable Racking

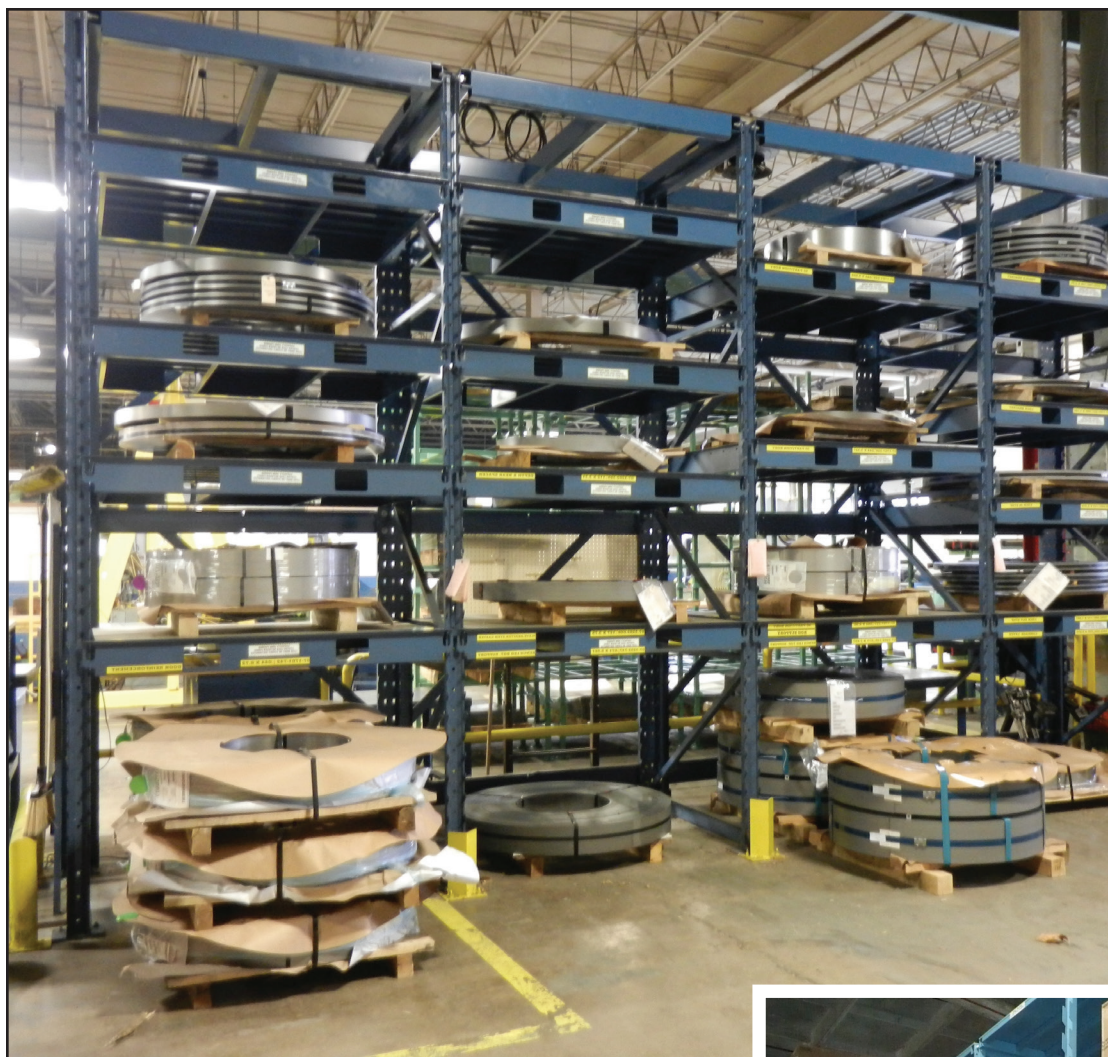

Available up to 16' high



Adjustable pallet positions

VERTICAL STORAGE

VIDMAR® STAK SYSTEM®

Easy storage. Even easier retrieval.

Storage and retrieval of heavy, bulky items has never been easier. Our STAK Systems® offer the ultimate in flexibility for storage, load capacity, space-savings, and money-savings.

Choose from:

- Access pallets with captive lifting device
- STAK System®—Removable, adjustable pallets and a captive lifting and handling device that facilitates retrieval in as little as two minutes. One operator can manage loads up to 2,000 lbs. in less than 250 square feet
- 4K STAK—All the features and benefits of STAK, plus the capability to build up to 18' 4" high and pallet loads up to 4,000 lbs. Choose from six additional pallet widths (19 sizes total)
- HazMat STAK System®—Designed specifically for the storage, staging, and retrieval of 55-gallon hazardous material drums, Factory Mutual Approval HazMat STAK System gets your drums off the floor and into their own dedicated storage system without having to use a conventional forklift



Designed for safety and ergonomic operation

VERTICAL STORAGE SOLUTIONS: STAK System®



One operator can manage loads up to 2,000 lbs.



Vidmar® STAK System®

VERTICAL STORAGE

DYNAMIC PALLET-BASED STORAGE AND HANDLING SYSTEM



Store or retrieve loads more quickly—regardless of size, shape, or weight!

- Space Savings—Squeeze wasted air out of your vertical storage and make use of every cubic foot! Free up floor space for other uses
- Value—Maximize the use of your cubic space, and get more productivity from your entire facility
- Manpower Efficiency—Retrieve items weighing up to 2 tons with just one person
- Ergonomic Safety—Lifting and handling device is engineered for maximum ease of use
- Ease of Retrieval and Inventory Control—Stored items are easily located, positioned and repositioned
- Precise Load Positioning—Pallets are positioned in the STAK System® at vertical increments of 4", so items can be stored exactly where you want them, on the fly
- Reduced Use of Fork Trucks—Fewer fork trucks means greater savings, greater safety on your shop floor and less wear and tear to floor
- Operation of the STAK System lifting and handling device doesn't require certification
- Product Protection and Security—Store large items on safe, protected pallets, off the floor.
- Ideal for work-in-process, maintenance, tooling and fixturing, and supply and distribution
- Available as 2K STAK System (2,000-lb. capacity), 4K STAK System (4,000-lb. capacity), or HazMat STAK System (2,000-lb. capacity). Consult factory for capacities above 4,000 lbs., extended height systems, or oversized pallets
- The STAK System is designed to be easily expanded incrementally as your storage needs grow
- With a long list of available accessories, your STAK System can be designed to your facility's exact requirements



Store a wide range of items of varying sizes, shapes and heights, with a minimum of wasted space!

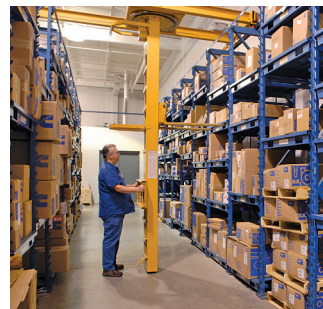

Aisle space requirements are narrower than those required when using a conventional forklift.



The system can be configured in a number of ways, and can incorporate mid-aisle access.

VERTICAL STORAGE SOLUTIONS: STAK System®



The STAK System® is available in a variety of configurations to suit your specific needs.

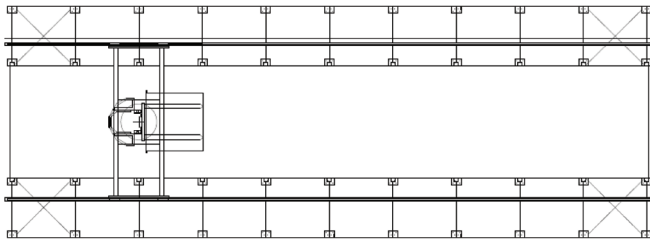

Double-sided standard

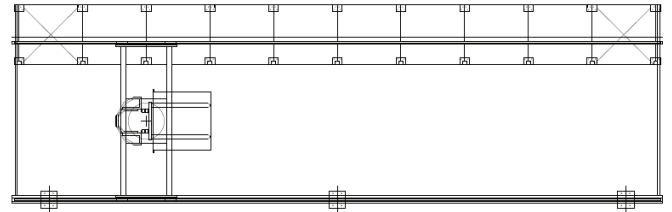

Single-sided

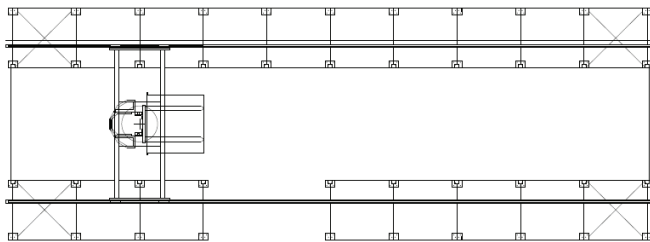

Double-sided with single mid-aisle access

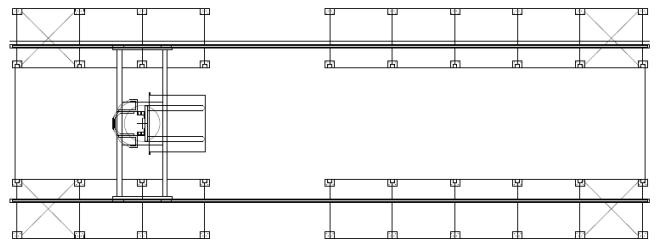

Double-sided with pair of mid-aisle access

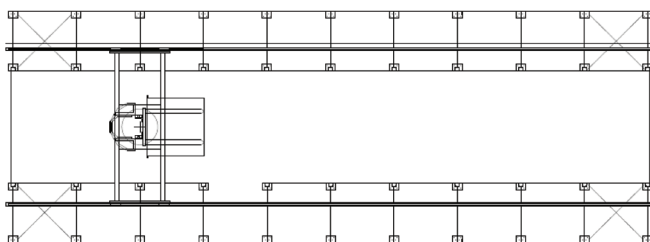

Double-sided with walk-through only access

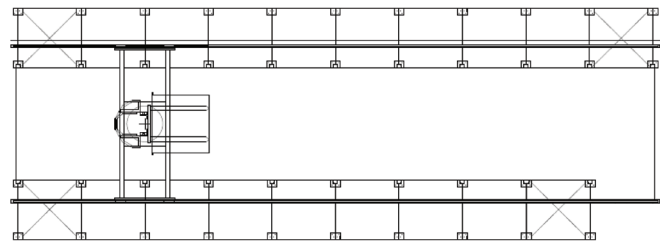

Double-sided with half cantilever

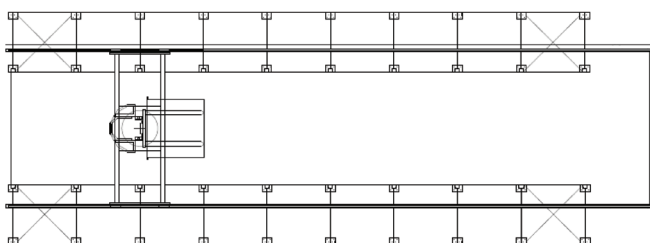

Double-sided with full cantilever

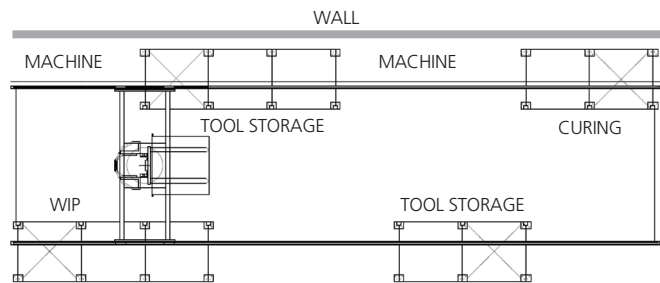

Flexible solutions to meet unique needs. Above layout is just an example of the configurations we can design to solve your tough problems.

VERTICAL STORAGE

VIDMAR® TOWER™ AND VIDMAR® TOWER XL™



A variety of Tower™ and Tower XL™ configurations offer your choice of performance and capacity for your particular storage needs. Tower-series storage solutions cover a range of module capacities, drawer capacities, vertical and horizontal speeds, and picking bay styles.

- Save more than 75% of your floor space
- Improve efficiency with faster part and tool retrieval
- Reduce labor with increased throughput rates
- Increase picking accuracy
- Minimize reaching, bending, and searching
- Improve inventory control
- Increase your bottom line



External picking bay



Internal picking bay



Unlimited drawer configurations



VERTICAL STORAGE SOLUTIONS: Tower



High-Density Storage:

The Vertical Lift Module is designed to take advantage of every inch of available space! Configure your drawers to maximize your storage capacity.

Closing Doors:

Sliding doors can be installed if doors need to be closed to avoid unauthorized access. Automatic closing doors are standard on internal bay machines, optional on external bay machines.

Fast Picking:

Maximize operator efficiency.

Safety:

Local lock-out and tag-out disconnects available, along with an emergency stop. All motors have brake locks, and all units have product height and personnel protection sensors.

Security:

Locking doors are optional; automatic doors are standard on internal bay machines, optional on others. User access is via password/barcode.

Flexible Bay Options:

Picking bays can be internal or external, front and back of machine, or stacked above one another.

Sliding Electronic Box:

Allows quick diagnosis and fast, safe maintenance.

Modular Construction:

The Vertical Lift Module can be built up to 40' high, with your choice of drawers, drawer height and depth, drawer configuration, and picking bay positioning.

Barcode Reader:

Bar code reader is designed to help pick stored items faster and more accurately. Wireless reader also available.

Ergonomic Bay Design:

Picking bays are designed to allow optimal picking times and help limit overreach.

Unlimited Drawer Configurations:

Drawers are available open or with adjustable partitions and dividers that can be custom-configured to suit your storage needs. Drawer height is adjustable.

Partitions & Dividers:

Plain or slotted partitions and dividers are available for the custom structuring of compartments (totes are also available). Raised drawer sides help contain bulky items.

Steel Core Belt

Vertical Transmission:

Quicker, more reliable, and less noisy than traditional chain transmission.

Computer-Based Operation:

Touch screen console allows easy access to all operational functions at any time. Drawers can be accessed by drawer number, part number, or part description.

Flexible Management Software:

Windows XP®-based management software is available in three basic configurations that offer thousands of operating possibilities.

Sliding Touch Screen Console:

Allows operator to work close to console at any picking point. Available with external bay only.

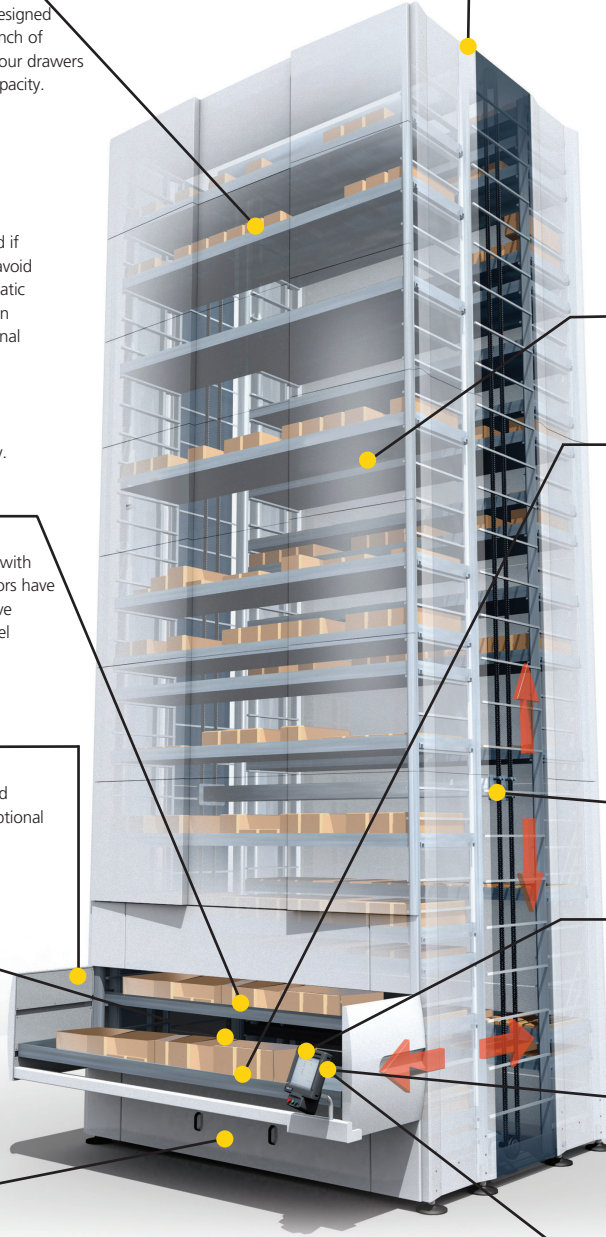

VERTICAL STORAGE

VIDMAR® MOTORIZED CAROUSEL



A Vidmar® Motorized Carousel maximizes vertical space, provides quick, easy access to hard-to-reach inventory, and offers complete load containment.

- One-Person Operation—Safely and easily rotate the shelves, locate the desired inventory item, stop at the proper position, and remove the product at floor level, without extra help
- Increased Safety—When the machine does the heavy lifting for you, the risk of injuries and muscle strains are reduced
- Higher Efficiency—Visible, organized inventory increases picking accuracy for fewer costly mistakes
- Security and Loss Prevention—Prevent unauthorized retrieval and use of the machine with an access keypad

PARTS

Who's in charge ...you or your inventory? Take back your warehouse by making parts come to you—safely and conveniently, whenever you need them.



Motorized Carousel features include wire-mesh front guarding and forward/reverse controls. Options include auto-retrieval and full enclosure.



P2418 Vertical Carousels

Carrier Size: 119" W x 24" D x 18" H

| MODEL # | HEIGHT | WIDTH | DEPTH | CARRIER QTY. |
|--------------|---------|--------|-------|--------------|
| P2418-10-120 | 12' 4" | 12' 0" | 6' 6" | 10 |
| P2418-11-120 | 13' 2" | 12' 0" | 6' 6" | 11 |
| P2418-12-120 | 14' 0" | 12' 0" | 6' 6" | 12 |
| P2418-13-120 | 14' 10" | 12' 0" | 6' 6" | 13 |
| P2418-14-120 | 15' 8" | 12' 0" | 6' 6" | 14 |
| P2418-15-120 | 16' 6" | 12' 0" | 6' 6" | 15 |
| P2418-16-120 | 17' 4" | 12' 0" | 6' 6" | 16 |

P1812 Vertical Carousels

Carrier Size: 119" W x 18" D x 12" H

| MODEL # | HEIGHT | WIDTH | DEPTH | CARRIER QTY. |
|--------------|---------|--------|-------|--------------|
| P1812-12-120 | 9' 10" | 12' 0" | 5' 8" | 12 |
| P1812-13-120 | 10' 5" | 12' 0" | 5' 8" | 13 |
| P1812-14-120 | 11' 0" | 12' 0" | 5' 8" | 14 |
| P1812-15-120 | 11' 7" | 12' 0" | 5' 8" | 15 |
| P1812-16-120 | 12' 2" | 12' 0" | 5' 8" | 16 |
| P1812-17-120 | 12' 9" | 12' 0" | 5' 8" | 17 |
| P1812-18-120 | 13' 4" | 12' 0" | 5' 8" | 18 |
| P1812-19-120 | 13' 11" | 12' 0" | 5' 8" | 19 |
| P1812-20-120 | 14' 6" | 12' 0" | 5' 8" | 20 |
| P1812-21-120 | 15' 1" | 12' 0" | 5' 8" | 21 |
| P1812-22-120 | 15' 8" | 12' 0" | 5' 8" | 22 |
| P1812-23-120 | 16' 3" | 12' 0" | 5' 8" | 23 |
| P1812-24-120 | 16' 10" | 12' 0" | 5' 8" | 24 |

VERTICAL STORAGE SOLUTIONS: Carousels

WIRE

The ergonomic design puts reels at a comfortable working position, increasing productivity and reducing the risk of injury.

- Accommodates multiple reel diameters and widths
- Equipped with a wire-mesh front guard
- Simple, push button controls

Wire Carousel Specs:

- Maximum Overall Capacity 13,000 lbs.
- Maximum Carrier Capacity 1,000 lbs.
- Electrical requirements 208V, 3PH, 60hz, 15 Amp
- Motor Horsepower 2 x 1.0 HP
- Off Balance Load Capacity 1,400 lbs.

Features:

- 2" Mesh Guarding
- Push Button Controls
- Security Keypad
- Main Power Disconnect
- Modular Design
- Loading Dolly

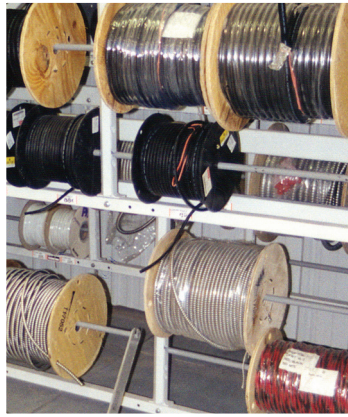

ROLLS

See and store your entire inventory using less square footage than traditional storage racks.

- Can be used in warehouse and floor displays
- Hinge arm loading system makes single-person loading easy
- Can be used for print material, rolled goods, parachute canvas



VERTICAL STORAGE

TIRES

Motorized Carousel's optional loading ramp makes it easy to safely store and retrieve tires up to 11" wide.



28" diameter tires (tire capacity based on 7" wide tire)

| MODEL # | CAPACITY | CARRIER WIDTH | HEIGHT | CAROUSEL WIDTH | DEPTH |
|------------------|----------|---------------|--------|----------------|-------|
| T39148-0740-SV12 | 147 | 12'7" | 13'2" | 14'7" | 6'11" |
| T39188-0940-SV12 | 189 | 12'7" | 16'6" | 14'7" | 6'11" |
| T39228-1140-SV12 | 231 | 12'7" | 19'10" | 14'7" | 6'11" |
| T39268-1340-SV12 | 273 | 12'7" | 23'2" | 14'7" | 6'11" |
| T39308-1540-SV12 | 315 | 12'7" | 26'6" | 14'7" | 6'11" |
| T39148-0740-SV15 | 189 | 15'7" | 13'2" | 17'9" | 6'11" |
| T39188-0940-SV15 | 243 | 15'7" | 16'6" | 17'9" | 6'11" |
| T39228-1140-SV15 | 297 | 15'7" | 19'10" | 17'9" | 6'11" |
| T39148-0740-SV18 | 224 | 18'7" | 13'2" | 20'9" | 6'11" |
| T39188-0940-SV18 | 288 | 18'7" | 16'6" | 20'9" | 6'11" |
| T39228-1140-SV18 | 352 | 18'7" | 19'10" | 20'9" | 6'11" |

32" diameter tires (tire capacity based on 9" wide tire)

| MODEL # | CAPACITY | CARRIER WIDTH | HEIGHT | CAROUSEL WIDTH | DEPTH |
|------------------|----------|---------------|--------|----------------|-------|
| T45156-0744-SV12 | 119 | 12'7" | 14'2" | 14'9" | 7'9" |
| T45200-0944-SV12 | 153 | 12'7" | 17'10" | 14'9" | 7'9" |
| T45244-1144-SV12 | 187 | 12'7" | 21'4" | 14'9" | 7'9" |
| T45156-0744-SV15 | 147 | 15'7" | 14'2" | 17'9" | 7'9" |
| T45200-0944-SV15 | 189 | 15'7" | 17'10" | 17'9" | 7'9" |

44" diameter tires (tire capacity based on 11" wide tire)

| MODEL # | CAPACITY | CARRIER WIDTH | HEIGHT | CAROUSEL WIDTH | DEPTH |
|-------------------|----------|---------------|--------|----------------|-------|
| HT54162-0563-SV12 | 65 | 12'6" | 15'0" | 14'11" | 9'4" |
| HT54193-0663-SV12 | 78 | 12'6" | 17'7" | 14'11" | 9'4" |
| HT54225-0763-SV12 | 91 | 12'6" | 20'3" | 14'11" | 9'4" |
| HT54256-0863-SV12 | 104 | 12'6" | 22'10" | 14'11" | 9'4" |
| HT54288-0963-SV12 | 117 | 12'6" | 25'6" | 14'11" | 9'4" |
| HT54319-1063-SV12 | 130 | 12'6" | 28'1" | 14'11" | 9'4" |

VERTICAL STORAGE SOLUTIONS: Carousels



Fully motorized for quick, easy storage and retrieval, Motorized Carousel is available in a number of preconfigured sizes or can be custom-configured to your exact specifications.

VERTICAL STORAGE

TOUGH STORAGE FOR A TOUGH WORLD.

Vidmar is America's premier manufacturer of custom modular storage systems used in unlimited industries including military, automotive, manufacturing, and healthcare. Designed to keep supplies close at hand, increase overall work efficiency, and cut down on lost parts and tools, all Vidmar storage cabinets are backed by a heavy-duty lifetime warranty.

When it comes to your specific needs, a Vidmar Territory Sales Manager will analyze your space and determine the Vidmar solutions that will most benefit your organization. From there, Vidmar will help you design a custom storage installation that holds up to your toughest day-to-day demands.

Save space, save time, and save money with a premium-strength storage solution that will grow as you grow. To schedule a free site analysis, call 800-523-9462 today.



PAINT FINISH

All Vidmar® cabinets, drawers and accessories are painted with an epoxy polyester-based powder coating.

This durable coating provides:

- An improved durability to surfaces (salt spray and scratch tests)
- Improved consistency in color

This environmentally-friendly paint is available in ten standard colors at no additional charge. (Non-standard and custom colors are available with additional charges added on a per-order basis.)

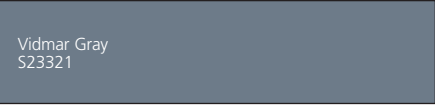
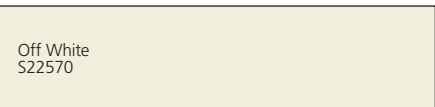

Miscellaneous: QuickShip



VIDMAR® QUICK SHIP ORDERING

Two day guaranteed shipment is now available on select Vidmar products.

Need to get organized fast? Vidmar will now ship a select group of popular products to you with 48 hours after ordering. Guaranteed. The Quick Ship ordering service includes preconfigured cabinets, mobile cabinets and workstations, technical benches and accessories.

VIDMAR® QUICK SHIP PRODUCTS

For a full list of Vidmar® Quick Ship products and to place an order, go online to www.STANLEYVidmar.com. Ground freight service in the Continental U.S. is free for customers.



www.STANLEYVidmar.com



QuickShip Section

LIFETIME GUARANTEE

binets are backed by a lifetime guarantee against defect of any kind. Lifetime cabinet guarantee does not cover damage caused by misuse or damage caused by use in excess of manufacturer's recommended capabilities.

These guarantees comprise the sole and entire guarantees pertaining to storage cabinets supplied by Vidmar. Vidmar makes no other warranty, guarantee, or representation of any kind whatsoever pertaining to the storage cabinets and storage equipment. All other guarantees, including but not limited to merchantability, fitness for particular purpose, and non-infringement, whether express, implied, or arising by operation of law, trade usage, or course of dealing, are hereby expressly disclaimed by Vidmar. Notwithstanding any of the provisions of this agreement or any incorporated documents, in no event shall Vidmar be liable for any exemplary, special, consequential, or incidental damages, including but not limited to loss of business or profits, loss of use, or loss of data, regardless of the form of the action, whether in contract or in tort.



Worksurfaces



Preconfigured Cabinets



Drawer Accessories

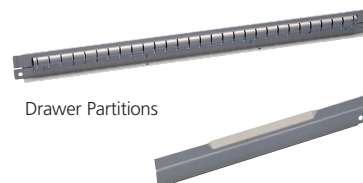

Drawer Partitions

Drawer Dividers

CABINET SPARE PARTS

- Minimum Order Qty
- 1 each unless specified

| MODEL # | DESCRIPTION | MODEL # | DESCRIPTION | MODEL # | DESCRIPTION |
|----------------------------------|---|---------|-------------|---------|-------------|
| AEROSOL PAINT | | | | | |
| ASP01 | Vidmar Gray, #S23321 | | | | |
| ASP02 | Vidmar Green, #S20606 | | | | |
| ASP06 | Olive Drab Green, #S22365 | | | | |
| ASP07 | Warm Gray, #S20917 | | | | |
| ASP08 | Medium Gray, #S22567 | | | | |
| ASP09 | Light Blue, #S22577 | | | | |
| ASP10 | Dark Blue, #S22578 | | | | |
| ASP11 | Bright Blue, #S22447 | | | | |
| ASP12 | Off-White, #S22570 | | | | |
| ASP13 | Beige, #S20100 | | | | |
| ASP19 | Industrial Brown, #S22569 | | | | |
| ASP21 | StaticGard™ Black, #SG100V | | | | |
| ASP28 | Safety Yellow, #S22645 | | | | |
| ASP30 | Safety Yellow, #SV773 | | | | |
| ASP44 | Hunter Green, #S50091 | | | | |
| ASP43 | Red, #S50054 | | | | |
| BASE COVERS (priced each) | | | | | |
| BCDW | Base Cover w/Fasteners, DW or DL | | | | |
| BCST | Base Cover w/Fasteners, ST or LW | | | | |
| BCSV | Base Cover w/Fasteners, SV | | | | |
| BCXW | Base Cover w/Fasteners, XW or XL | | | | |
| BOOKCASE | | | | | |
| 5-138-340-02 | H Clip for BS30 Shelf | | | | |
| CABINET LABELS | | | | | |
| 6-100-340-20 | Label, Vidmar Nameplate | | | | |
| 047435 | Label, Static Caution | | | | |
| CABINET PLUG | | | | | |
| 6-100-340-24 | Plugbutton for Lock Hole | | | | |
| CARRIAGES | | | | | |
| CARRDW | Carriage, DW | | | | |
| CARRLW | Carriage, LW | | | | |
| CARRST | Carriage, Standard | | | | |
| CARRSV | Carriage, SV | | | | |
| CARRXL | Carriage, XL | | | | |
| CARRXW | Carriage, XW | | | | |
| CARRDL | Carriage, DL | | | | |
| CARRSL | Carriage, SL | | | | |
| SGCARRST | SG Carriage, Standard | | | | |
| SGCARRLW | SG Carriage, LW | | | | |
| CARRIAGE BRACKETS | | | | | |
| CBLWL | Carriage Bracket w/Screw, LW, LH | | | | |
| CBLWR | Carriage Bracket w/Screw, LW, RH | | | | |
| CBSTL | Carriage Bracket w/Screw, ST, LH | | | | |
| CBSTR | Carriage Bracket w/Screw, ST, RH | | | | |
| CBPLWL | Painted Carriage Bracket, LW-LH | | | | |
| CBPLWR | Painted Carriage Bracket, LW-RH | | | | |
| CBPSTL | Painted Carriage Bracket, ST-LH | | | | |
| CBPSTR | Painted Carriage Bracket, ST-RH | | | | |
| CARRIAGE STOP LATCHES | | | | | |
| 5-109-020-21 | Carriage Stop Latch, LH | | | | |
| 5-109-020-22 | Carriage Stop Latch, RH | | | | |
| CASTERS/ CASTER KITS | | | | | |
| CKR5HR | Rigid, 5" Hard Rubber Wheel | | | | |
| CKR6PP | Rigid, 6" Polyloc Wheel | | | | |
| CKS5HR | Swivel, 5" Hard Rubber Wheel | | | | |
| CKS6PP | Swivel, 6" Polyloc Wheel | | | | |
| 046400 | Swivel, 2" Stem Caster | | | | |
| DRAWER PULL END CAPS | | | | | |
| ECDPPKG1 | End Caps, Drw. Pull, Pkg. of 25 R and L | | | | |
| ECDPPKG2V | New Style End Caps, Drw. Pull, Pkg. of 25 R and L | | | | |
| ECDPPKGBK | Black End Caps, Drw. Pull, Pkg of 25 R and L | | | | |
| DRAWER PULL KITS | | | | | |
| DPK901SVPKG1 | 901 Drw Pull Kit-SV, Pkg. of 10 | | | | |
| DPKSDPKG1 | Door Pull Kit, Shelf Door, Pkg. of 10 | | | | |
| DPKSTPKG1 | Drawer Pull Kit, Std, Pkg. of 10 | | | | |
| DPKSVPKG1 | Drawer Pull Kit, SV, Pkg. of 10 | | | | |
| SGDPK901 | SG 901 Drw Pull Kit-SV, Pkg. of 10 | | | | |
| SGDPKSTPKG1 | SG Drawer Pull Kit, Std, Pkg. of 10 | | | | |
| SGDPKSVPKG1 | SG Drawer Pull Kit, SV, Pkg. of 10 | | | | |
| DPKSTPKG2BK | Drw Pull black end caps, Pkg. of 10 | | | | |
| HARDWARE | | | | | |
| 6-100-340-25 | Base Cover Fastener Kit (Qty. 2) | | | | |
| BCSCR | Base Cover Screw (each) | | | | |
| SCRCSB | Carriage Bracket Screw | | | | |
| 4-168-340-05 | Caster Nut | | | | |
| 6-160-000-14 | Hardware Kit, Bench Leg | | | | |
| 6-165-000-02 | Laminate Plastic and Hardwood Hdwr Kit | | | | |
| SCREWPKG | Partition Screws, Package of 100 | | | | |
| SCRDP | Screw, Drawer Pull | | | | |
| STH1 | Stak Top Hardware | | | | |
| KEYS | | | | | |
| KEY1 | Key for Vidmar Locks (specify combination) | | | | |
| KEY2 | SL10 Master Key | | | | |
| LOCK CYLINDERS | | | | | |
| CYLSDL1 | Threaded Shelf Door Lock Cylinder | | | | |
| CYLSDLLH | Shelf Door Lock Cylinder, LH | | | | |
| CYLSDLRH | Shelf Door Lock Cylinder, RH | | | | |
| CYLSEC1 | Security Drawer Lock Cylinder, Top | | | | |
| CYLSEC2 | Security Drawer Lock Cylinder | | | | |
| CYLSEC3 | Threaded Sec. Drw. Lock Cyl., Top | | | | |
| CYLSEC4 | Threaded Sec. Drw. Lock Cyl. | | | | |
| A10712 | Bayonet Lock Cyl and Key for Sliding Door | | | | |
| CYLSL | Lock Cylinder - SL10 | | | | |



ECDPPKG1



ECDPPKG2V



ECDPPKGBK

Accessories/Spare Parts



CABINET SPARE PARTS

- Minimum Order Qty
- 1 each unless specified

| MODEL # | DESCRIPTION |
|--------------|---|
| LOCK PARTS | |
| 4-100-040-12 | Lock Hinge, 040 Cabinet, Universal |
| 4-100-060-12 | Lock Hinge, 060 Cabinet, Universal |
| 4-100-135-12 | Lock Hinge, 135 Cabinet, Universal |
| 4-100-155-12 | Lock Hinge, 155 Cabinet, Universal |
| 4-100-175-12 | Lock Hinge, 175 Cabinet, Universal |
| 4-100-200-14 | Lock Hinge, 200 Cabinet, Universal |
| 4-100-245-14 | Lock Hinge, 245 Cabinet, Universal |
| 4-100-340-14 | Lock Hinge, 340 Cabinet, Universal |
| 4-152-340-25 | Lock Toggle, Single Cabinet |
| 4-152-341-04 | Lock Rod, SL10 |
| 4-152-343-03 | Lock Toggle, Double |
| 5-100-340-39 | Lock Bracket |
| 5-144-340-15 | Bracket, Shelf Door, Magnetic Catch |
| 6-101-001-16 | Hinge Lock Bar Pin, Universal |
| 6-144-340-13 | Shelf Door Magnet, Standard |
| 6-144-517-21 | Shelf Door Magnet, DW or XW |
| 6-152-001-02 | Lock Rod Mold Cam Washer |
| OSSL10 | Old Style SL10 Lock Assembly |
| RODGN10 | Lock Rod and Toggle, GN-10 |
| RODGN10R | Lock Rod and Toggle, GN-10R |
| ROSDSL135 | Lock Rod Kit, SDL 135, Old Style |
| ROSDSL1351 | Lock Rod Kit, SDL 1351, Threaded |
| ROSDSL155 | Lock Rod Kit, SDL 155, Old Style |
| ROSDSL1551 | Lock Rod Kit, SDL 1551, Threaded |
| ROSDSL175 | Lock Rod Kit, SDL 175, Old Style |
| ROSDSL1751 | Lock Rod Kit, SDL 1751, Threaded |
| ROSDSL245 | Lock Rod Kit, SDL 245, Old Style |
| ROSDSL2451 | Lock Rod Kit, SDL 2451, Threaded |
| ROSDSL340 | Lock Rod Kit, SDL 340, Old Style |
| ROSDSL3401 | Lock Rod Kit, SDL 3401, Threaded |
| ROSDSL3400S | Lock Rod Kit, SDL 340, Old Style |
| RODSL10 | Lock Rod and Toggle, SL10 |
| RODSL10L | Lock Rod and Toggle, SL10L (Left-Hand Assembly) |
| RODSL10R | Lock Rod and Toggle, SL10R (Double Toggle) |

| MODEL # | DESCRIPTION |
|--------------------------------|---------------------------------|
| MR & ML LATCHES | |
| MLLK | ML Latch Kit |
| MRLK | MR Latch Kit |
| PAPER LABELS FOR LABEL HOLDERS | |
| PLALH13 | Paper Label, ALH13 |
| PLBLH | Paper Label, BLH02 |
| PLLH01 | Paper Label, LH01 |
| PLLH04 | Paper Label, LH04 |
| PLLH06 | Paper Label, LH06 |
| PENDAFLEX | |
| 8-112-070-01 | Metal Pendaflex Frame |
| SHELF BRACKETS | |
| OSSBSTL | Old-Style Shelf Bracket, ST, LH |
| OSSBSTR | Old-Style Shelf Bracket, ST, RH |
| SBLWL | Shelf Bracket, LW, LH |
| SBLWR | Shelf Bracket, LW, RH |
| SBSTL | Shelf Bracket, Standard, LH |
| SBSTR | Shelf Bracket, Standard, RH |
| TAPE | |
| DTAA | Desk Top Adhesive |
| DST01 | Double-Sided Tape for Tops |

| MODEL # | DESCRIPTION |
|---|---|
| VINYL SHIELDS/PAPER LABEL SETS FOR DRAWER/DOOR PULL | |
| VSPLSD* | Vinyl, Paper, Shelf Door Pull, 5" |
| VSPLDPOS | Vinyl, Paper, Drw. Pull, OS, 25.5" |
| VSPLDPST* | Vinyl, Paper, Drw. Pull, Standard, 22" |
| VSPLDPSV* | Vinyl, Paper, Drw. Pull, SV, 15" |
| SGVSPDPST | SG Vinyl, Paper, Drw. Pull, Standard, 22" |
| SGVSPDPSTV | SG Vinyl, Paper, Drw. Pull, SV, 15" |
| 045531-1 | XW full width vinyl, paper |
| VINYL SHIELDS/PAPER LABEL SETS FOR LABEL HOLDER | |
| VSPLGTL22 | Vinyl, Paper - GTL22 |
| VSPLGTL37 | Vinyl, Paper - GTL37 |
| VSPLGTL58 | Vinyl, Paper - GTL58 |
| VSPLLH01 | Vinyl, Paper - LH01, 1-3/16" |
| VSPLLH04 | Vinyl, Paper - LH04, 2-5/8" |
| VSPLLH06 | Vinyl, Paper - LH06, 4-3/16" <i>Vidmar® Quick Ship</i> |

CABINET ANCHORING KITS

- For securing single cabinets to the floor (All cabinets should be securely fastened to the floor)
- Kit consists of two screws, washers and anchors
- Specify the appropriate hardware for your floor

| MODEL # | DESCRIPTION |
|---------|---------------------|
| CAK-1 | For concrete floors |
| CAK-2 | For wood floors |

CABINET ANCHORING KITS

| MODEL # | DESCRIPTION |
|---------|---|
| CCH-1 | Contains 4 sets of 5/16-18 hardware to attach 2 cabinet housings side to side or 4 cabinet housings back to back |
| CCH-2 | Contains 4 sets of 3/8-16 grade 5 hardware to attach 2 cabinet housings side to side or 4 cabinet housings back to back, recommended for seismic zone 3 and above |
| CCH-3 | Contains 4 sets of 1/4-20 hardware to attach 2 auto technician overhead cabinet housings side to side |



CCH-1



CAK-1



CAK-2

VERTICAL STORAGE PARTS

VIDMAR® PAINT FINISHES

Medium Gray
S22567

Warm Gray
S20917

Olive Drab Green
S22365

Off White
S22570

Beige
S20100

Vidmar Green
S20606

Hunter Green
S50091

Light Blue
S22577

Bright Blue
S22447

Dark Blue
S22578

Red
S50054

Vidmar Gray
S23321

Black
S20106





Smart Versatile Storage.

11 Grammes Road, Allentown, PA 18103 • US/Canada 800-523-9462 • STANLEYVidmar.com

ENVIRONMENTAL MANAGEMENT SYSTEM
 CERTIFIED BY DNV
 === ISO 14001:2004 ===

OCCUPATIONAL HEALTH AND SAFETY
 MANAGEMENT SYSTEM
 CERTIFIED BY DNV
 === OHSAS 18001 ===

QUALITY MANAGEMENT SYSTEM
 CERTIFIED BY DNV
 === ISO 9001:2008 ===