

I BALOCCHI系列

技术说明书

I BALOCCHI系列

Design Davide Mercatali & Paolo Pedrizzetti



29 0504

面盆龙头	页.434
妇洗器	页.435
淋浴系列	页.437
淋浴：渐进式阀芯组合	页.446
淋浴：恒温阀芯组合	页.447
浴缸龙头	页.448
浴缸龙头：出水嘴	页.449
厨房系统	页.449
杂项物品	页.449

技术信息

I BALOCCHI系列标准是带有手柄的。

所有的面盆和净身盆龙头均配有5 l / m限流器。

面盆穿孔：

- 单孔面盆和妇洗器水龙头。

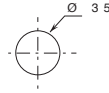

- 三孔式面盆龙头组。

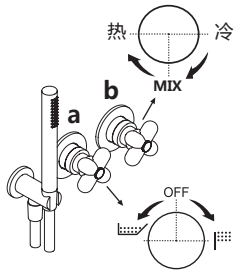
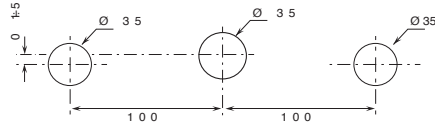

1/2" 恒温淋浴预埋控制阀芯有两个控制器：

- 款式. 0384B/0384A - 两向出水

a) 带闭合装置的旋钮式分水器 - 带闭合装置的旋钮式分水器 - 初始为正中心位置，朝右旋转可开启1号出水口，旋转回原位可以关闭水流，朝左旋转可开启2号出水口。

b) 温度调节控制柄。

基材：黄铜

漆面：

06 红色(劳尔色卡3000)

13 哑光黑色(劳尔色卡9005)

29 哑光白色(劳尔色卡9016)



06- 红色



29 - 哑光白色



13 - 哑光黑色

定制RAL颜色

最小订购量：3 件。

在这个数量下，需要支付净价100欧元的定制费。

价格请参考以下页码。

交货时间为订单确认后 **8 * 10 周**。

* 有关备件、配件、杂项型号和延长件，请参阅特定价目表部分

1/4转陶瓷阀芯

三孔式面盆龙头组

龙头出水口长度11,5cm



0504
带下水

单孔式面盆龙头组

龙头出水口长度11,5cm



0556F
带下水

墙装面盆龙头组

龙头出水口长度20cm

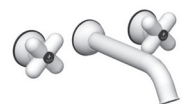

0511B+R010A
不带排水

单孔式妇洗器龙头组

龙头出水口长度12cm



0562F
带下水

厨房龙头：总表

1/4转陶瓷阀芯

单孔式厨房水槽龙头组

龙头出水口长度18cm



0550F
不带排水

0504 lead∅free

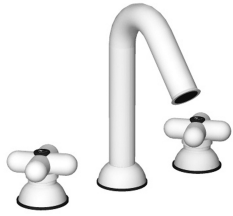

三孔式面盆龙头

- 龙头出水口长度11.5cm
- 开关手柄
- 流速限制器 5升/分钟 3 bar
- 90°陶瓷阀芯
- 供水软管
- 按压式去水塞

哑光黑
哑光白色
红色
定制RAL颜色

60 13 0504
60 29 0504
60 06 0504
60 _ 0504

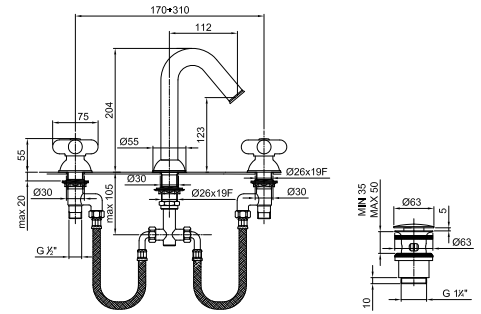

0556F



单孔式面盆龙头组

- 龙头出水口长度11.5cm
- 开关手柄
- 流速限制器 5升/分钟 3 bar
- 90°陶瓷阀芯
- 供水软管
- 按压式去水塞

哑光黑
哑光白色
红色
定制RAL颜色

60 13 0556F
60 29 0556F
60 06 0556F
60 _ 0556F

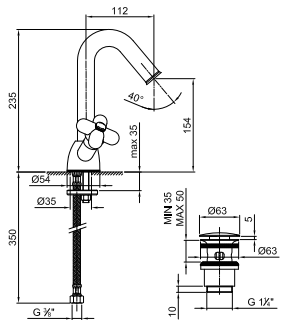

lead∅free

墙出面盆龙头

- 龙头出水口长度20cm
- 开关手柄
- 流速限制器 5升/分钟 3 bar
- 90°陶瓷阀芯
- 1/2" 寸入水管
- 不带排水塞

0511B

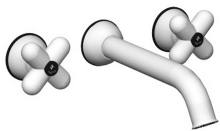

外部组件

哑光黑
哑光白色
红色
定制RAL颜色

60 13 0511B
60 29 0511B
60 06 0511B
60 _ 0511B

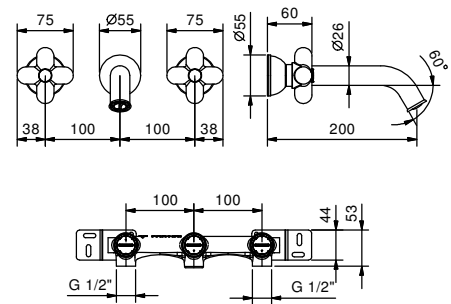

R010A

墙内预埋组件

44 00 R010A

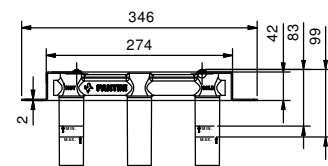

0562F

单孔式妇洗器

- 龙头出水口长度12cm
- 开关手柄
- 流速限制器 5升/分钟 3 bar
- 90°陶瓷阀芯
- 铰接式起泡器
- 供水软管
- 带排水塞



哑光黑
哑光白色
红色
定制RAL颜色

60 13 0562F
60 29 0562F
60 06 0562F
60 _ 0562F

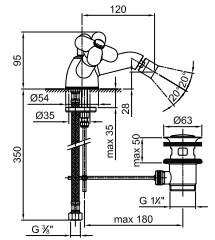

渐进式新型阀芯 渐进式新型阀芯

预埋式淋浴混合器

_1/2" 寸入水管



0384B+0384A

双出水口

恒温阀芯

预埋式淋浴混合器

_3/4" 寸入水管



0600B+3900A



0690B+6090A

止水阀

预埋分水器

_1/2" 寸入水管



0676B+D276A

双出水口



0676B+D277A

三出水口

预埋式淋浴混合器

_3/4" 寸入水管



0601B+6001A

单出水口



0602B+6002A

双出水口



0603B+6003A

三出水口

预埋式浴缸/淋浴开关

- 开关手柄
- 旋钮式带关闭2向分水器
- FIT系列手持花洒
- 带手持花洒托架的取水栓
- 150cm PVC软管
- 150厘米黄铜软管，有06和Ral漆面版本供您选择
- 1/2" 寸入水管
- 静音系统

0384B

外部组件

哑光黑	60 13 0384B
哑光白色	60 29 0384B
红色	60 06 0384B
定制RAL颜色	60 _ 0384B

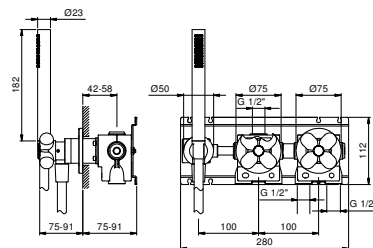
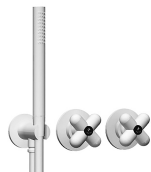

0384A

墙内预埋组件

22 00 0384A



3/4"寸管径预埋式恒温开关

- 开关手柄
- 3/4" 寸入水管
- 静音系统
- 不带止流阀 需要单独预定

注意：混水器必须与止流阀一同订购产品编号：0690B+6090A或分水阀 0676B+D277A 或 0676B+D276A

0600B

外部组件

哑光黑	60 13 0600B
哑光白色	60 29 0600B
红色	60 06 0600B
定制RAL颜色	60 _ 0600B

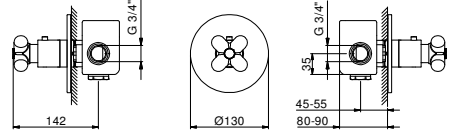

3900A

墙内预埋组件

19 00 3900A



3/4" 寸管径止水阀

- 开关手柄
- 90°陶瓷阀芯
- 3/4" 寸入水管
- 静音系统

0690B

外部组件

哑光黑	60 13 0690B
哑光白色	60 29 0690B
红色	60 06 0690B
定制RAL颜色	60 _ 0690B

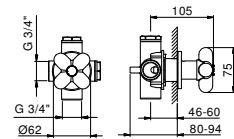

6090A

墙内预埋组件

19 00 6090A



1/2"寸管径两出水分水器预埋部分

- 开关手柄
- 旋钮式带关闭2向分水器
- 带闭合开关
- 1/2" 寸入水管

0676B

外部组件

哑光黑	60 13 0676B
哑光白色	60 29 0676B
红色	60 06 0676B
定制RAL颜色	60 _ 0676B

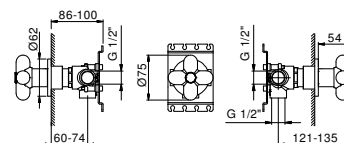

D276A

墙内预埋组件

19 00 D276A



1/2"寸管径三出水分水器预埋部分

- 开关手柄
- 旋钮式带关闭3向分水器
- 带闭合开关
- 1/2" 寸入水管

0676B

外部组件

哑光黑	60 13 0676B
哑光白色	60 29 0676B
红色	60 06 0676B
定制RAL颜色	60 _ 0676B

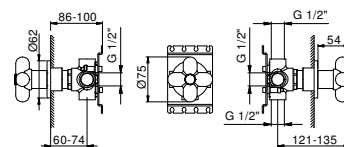

D277A

墙内预埋组件

19 00 D277A



3/4"寸管径预埋式恒温开关

- 3/4"寸出水口径
- 开关手柄
- 3/4"寸入水管
- 静音系统

0601B

外部组件

哑光黑	60 13 0601B
哑光白色	60 29 0601B
红色	60 06 0601B
定制RAL颜色	60 _ 0601B

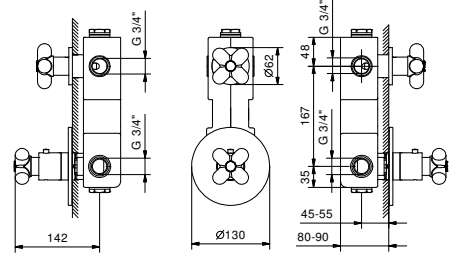

6001A

墙内预埋组件

19 00 6001A



3/4"寸管径预埋式恒温开关

- 3/4"寸管径2出水口
- 开关手柄
- 3/4"寸入水管
- 静音系统

0602B

外部组件

哑光黑	60 13 0602B
哑光白色	60 29 0602B
红色	60 06 0602B
定制RAL颜色	60 _ 0602B

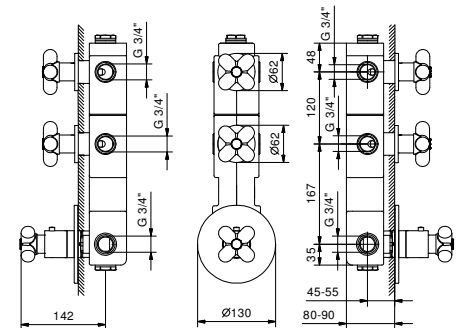

6002A

墙内预埋组件

19 00 6002A



3/4"寸管径预埋式恒温开关

- 3/4"寸管径3出水口
- 开关手柄
- 3/4"寸入水管
- 静音系统

0603B

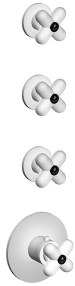

外部组件

哑光黑	60 13 0603B
哑光白色	60 29 0603B
红色	60 06 0603B
定制RAL颜色	60 _ 0603B

6003A



墙内预埋组件

19 00 6003A

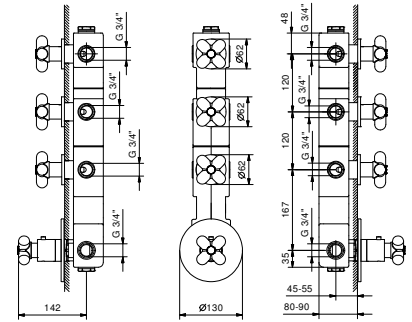

8136

雨式花洒

- 直径20cm
- 基材：黄铜
- 流速限制器12升/分钟 3 bar
- 防钙化系统
- 1/2" 寸入水管
- 止回阀

注意：保证产品正确运行的必要条件 水流量不小于：10升/分钟

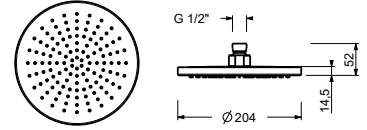

哑光黑	86 13 8136
哑光白色	86 29 8136
红色	86 06 8136
定制RAL颜色	86 _ 8136

9230

雨式花洒

- 直径20cm
- 基材：黄铜
- 流速限制器12升/分钟 3 bar
- 防钙化系统
- 1/2" 寸入水管
- 止回阀

注意：保证产品正确运行的必要条件 水流量不小于：10升/分钟

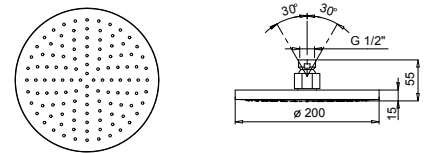

哑光黑	86 13 9230
哑光白色	86 29 9230
红色	86 06 9230
定制RAL颜色	86 _ 9230

8027

花洒臂

- 长度30cm
- 圆形底座
- 墙面装
- 1/2" 寸入水管



哑光黑	86 13 8027
哑光白色	86 29 8027
红色	86 06 8027
定制RAL颜色	86 _ 8027

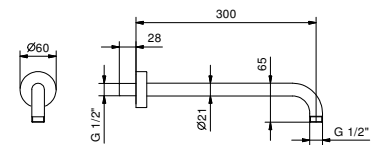

选配：适用石膏板的预埋件

W046 91 00 W046

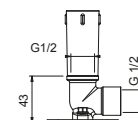

8137

花洒臂

- 长度35cm
- 圆形底座
- 墙面装
- 1/2" 寸入水管



哑光黑	86 13 8137
哑光白色	86 29 8137
红色	86 06 8137
定制RAL颜色	86 _ 8137

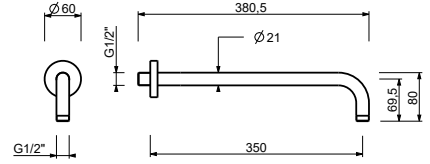

选配: 适用石膏板的预埋件

W046	91 00 W046
-------------	------------

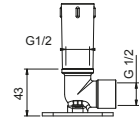

8028

花洒臂

- 长度45cm
- 圆形底座
- 墙面装
- 1/2" 寸入水管



哑光黑	86 13 8028
哑光白色	86 29 8028
红色	86 06 8028
定制RAL颜色	86 _ 8028

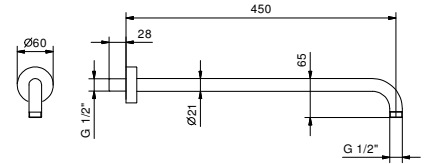

选配: 适用石膏板的预埋件

W046	91 00 W046
-------------	------------

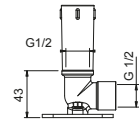

9236

花洒臂

- 长度25cm
- 圆形底座
- 天花板吊顶安装
- 1/2" 寸入水管



哑光黑	86 13 9236
哑光白色	86 29 9236
红色	86 06 9236
定制RAL颜色	86 _ 9236

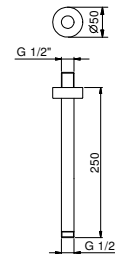

选配: 适用石膏板的预埋件

W046	91 00 W046
-------------	------------

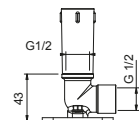

9237

花洒臂

- 长度45cm
- 圆形底座
- 天花板吊顶安装
- 1/2" 寸入水管



哑光黑	86 13 9237
哑光白色	86 29 9237
红色	86 06 9237
定制RAL颜色	86 _ 9237

选配: 适用石膏板的预埋件

W046	91 00 W046
-------------	------------

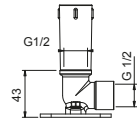
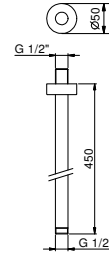

8783

手持花洒

- FIT 系列
- 基材: 黄铜
- 流速限制器 9升/分钟
- 防钙化系统
- 止回阀



哑光黑	90 13 8783
哑光白色	90 29 8783
红色	90 06 8783
定制RAL颜色	90 _ 8783

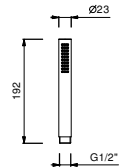

9323

取水栓

- 圆形底座
- 基材: 黄铜
- 手持花洒固定托架
- 软管通过锥形螺母连接



哑光黑	91 13 9323
哑光白色	91 29 9323
红色	91 06 9323
定制RAL颜色	91 _ 9323

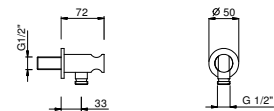

7034

取水栓

- 圆形底座
- 基材: 黄铜
- 不带手持花洒托架



哑光黑	91 13 7034
哑光白色	91 29 7034
红色	91 06 7034
定制RAL颜色	91 _ 7034

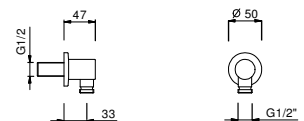

9349

软管

- 基材：PVC
- 长150cm
- 直径1/2英寸，锥形螺母，底宽1/2英寸

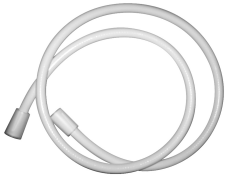

哑光黑
乳白色

90 13 9349
90 26 9349

0819

软管

- 基材：黄铜
- 长150cm
- 直径15mm



红色
定制RAL颜色

90 06 0819
90 _ 0819

9671

软管

- 基材：PVC
- 长200cm
- 直径1/2英寸，锥形螺母，底宽1/2英寸



哑光黑
乳白色

90 13 9671
90 26 9671

淋浴：渐进式阀芯组合

I BALOCCHI系列

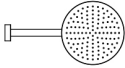
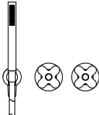
组合.1	款式.	描述	漆面
	8136	雨式花洒	13 哑光黑
	8027	花洒臂	29 哑光白色
	0384B+0384A	预埋式浴缸/淋浴开关	06 红色
			— 定制RAL颜色
			

淋浴：恒温阀芯组合

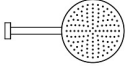
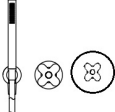
组合.1	款式.	描述	漆面
	8136	雨式花洒	13 哑光黑
	9349	软管	29 哑光白色
	0676B+D276A	1/2"寸管径两出水分水器预埋部分	
	9323	取水栓	
	8027	花洒臂	
	0600B+3900A	3/4"寸管径预埋式恒温开关	
	8783	手持花洒	
			

1/4转陶瓷阀芯

墙装浴缸龙头组



0516
双出水口

0516

墙装浴缸龙头组

- 龙头出水口长度15.4cm
- 开关手柄
- 手动2向分水器
- FIT系列手持花洒
- 手持花洒托架
- 150cm PVC软管
- 150厘米黄铜软管，有06和Ral漆面版本供您选择
- 90°陶瓷阀芯

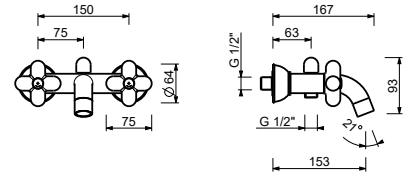

哑光黑	60 13 0516
哑光白色	60 29 0516
红色	60 06 0516
定制RAL颜色	60 _ 0516

浴缸龙头：出水嘴

0545

墙装式浴缸出水口

- 龙头出水口长度20cm
- 1/2" 寸入水管

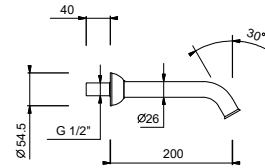

哑光黑	60 13 0545
哑光白色	60 29 0545
红色	60 06 0545
定制RAL颜色	60 _ 0545

厨房系统：1/4转陶瓷阀芯

0550F

单孔式厨房水槽龙头组

- 龙头出水口长度18cm
- 开关手柄
- 可转动出水口
- 流速限制器 8升/分钟 3 bar
- 供水软管
- 不带排水塞

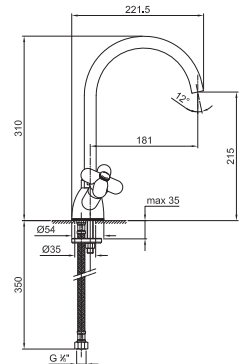

哑光黑	60 13 0550F
哑光白色	60 29 0550F
红色	60 06 0550F
定制RAL颜色	60 _ 0550F

8434

排水塞

- 1" 1/4
- 按压式去水塞
- 不带防溢孔的面盆
- 用于带防溢孔的面盆
- 通用的

备注：价格表末尾杂项部分中的完整整理表

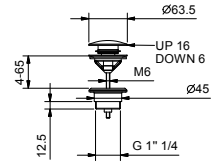

哑光黑	91 13 8434
哑光白色	91 29 8434
红色	91 06 8434
定制RAL颜色	91 _ 8434

8435

排水塞

- 1" 1/4
- 不带防溢孔的面盆
- 用于带防溢孔的面盆
- 自由出水
- 通用的

备注：价格表末尾杂项部分中的完整整理表

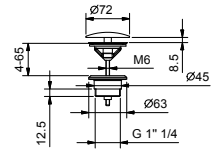

哑光黑	91 13 8435
哑光白色	91 29 8435
红色	91 06 8435
定制RAL颜色	91 _ 8435

9234

瓶式虹吸

- 1" 1/4
- 用于面盆

备注：价格表末尾杂项部分中的完整整理表

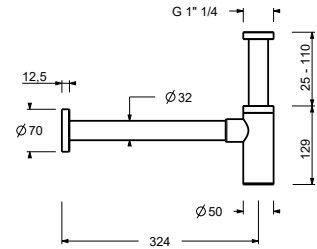

哑光黑	91 13 9234
哑光白色	91 29 9234
红色	91 06 9234
定制RAL颜色	91 _ 9234

8364

双过滤阀

- 带闭合开关
- 可拆卸过滤装置
- 1/2" 寸入水管

备注：价格表末尾杂项部分中的完整整理表

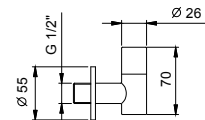

哑光黑	91 13 8364
哑光白色	91 29 8364
红色	91 06 8364
定制RAL颜色	91 _ 8364

8402

冲水控制板

- 基材：不锈钢
- 凸出的控制按钮
- 带圆形按钮
- 与GEBERIT SIGMA8, SIGMA12匹配
- 无可视固定装置

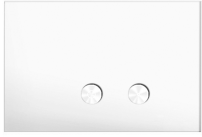

备注：价格表末尾杂项部分中的完整整理表

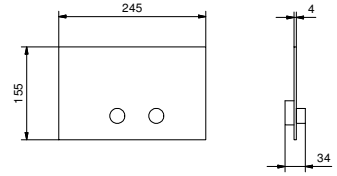

- | | |
|------|------------|
| 哑光黑 | 91 13 8402 |
| 哑光白色 | 91 29 8402 |
| 红色 | 91 06 8402 |

8403

冲水控制板

- 基材：不锈钢
- 线式控制
- 带方形按钮
- 与GEBERIT SIGMA8, SIGMA12匹配
- 无可视固定装置



备注：价格表末尾杂项部分中的完整整理表

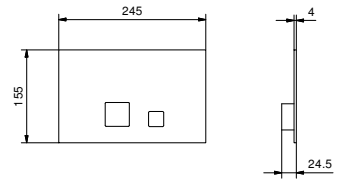

- | | |
|------|------------|
| 哑光黑 | 91 13 8403 |
| 哑光白色 | 91 29 8403 |
| 红色 | 91 06 8403 |

W216

冲水控制板

- 基材：不锈钢
- 凸出的控制按钮
- 带圆形按钮
- 与TECEBOX OCTA II匹配
- 最小深度：请参见安装说明
- 无可视固定装置

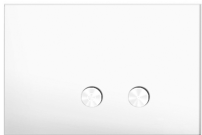

备注：价格表末尾杂项部分中的完整整理表

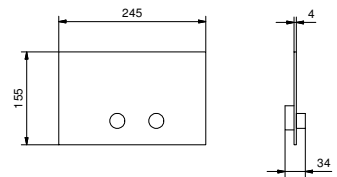

- | | |
|------|------------|
| 哑光黑 | 91 13 W216 |
| 哑光白色 | 91 29 W216 |
| 红色 | 91 06 W216 |

W001

浴缸排水柱

- 带开关把手
- 带排水



备注：价格表末尾杂项部分中的完整整理表

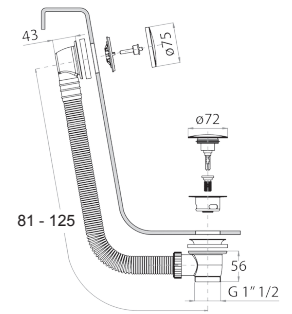

- | | |
|---------|------------|
| 哑光黑 | 91 13 W001 |
| 哑光白色 | 91 29 W001 |
| 红色 | 91 06 W001 |
| 定制RAL颜色 | 91 _ W001 |

W002

浴缸排水柱

- 带开关把手
- 浴缸防溢排水口
- 带排水

备注：价格表末尾杂项部分中的完整整理表



哑光黑
哑光白色
红色
定制RAL颜色

91 13 W002
91 29 W002
91 06 W002
91 _ W002

