

I BALOCCHI

MANUALE TECNICO

I BALOCCHI

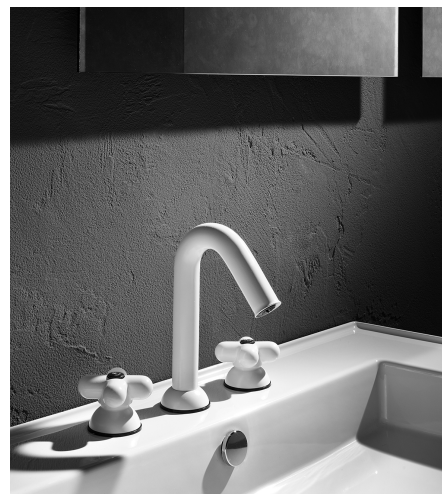

LAVABO

vitoni ceramici da 1/4 di giro pag. 14

BIDET

vitoni ceramici da 1/4 di giro pag. 15

DOCCIA

cartuccia progressiva pag. 17

cartuccia termostatica pag. 18

composizioni cartuccia progressiva pag. 26

composizioni cartuccia termostatica pag. 26

VASCA pag. 28

CUCINA

vitoni ceramici da 1/4 di giro pag. 29

ARTICOLI VARI pag. 30

Informazioni tecniche

I gruppi e miscelatori I BALOCCHI sono forniti di serie **CON MANIGLIA**.

I miscelatori lavabo e bidet sono dotati di **aeratori limitati** a 5 l/min.

FORATURA DEI PIANI SANITARI:

- Miscelatori lavabo e bidet monoforo.

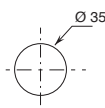

- Gruppo lavabo 3 fori.

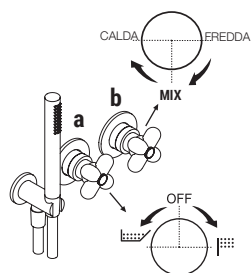
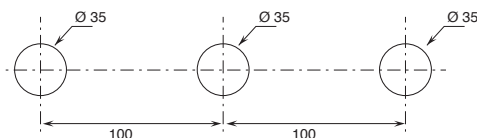

Il miscelatore progressivo doccia incasso 1/2" ha due comandi:

- **art. 0384B/0384A** - due uscite

a) deviatore a rotazione con chiusura - Partendo dalla posizione centrale ruotando verso DX si attiva la 1° uscita, al centro la chiusura, ruotando verso SX si attiva la 2° uscita.

b) comando per la regolazione della temperatura.

Materiali di base:

- Ottone

0602 Rosso (RAL 3000) / Cromo

13 Nero opaco (RAL 9005)

29 Bianco opaco (RAL 9016)



0602 - Rosso / Cromo
(finiture cromo)



29 - Bianco opaco
(Tutto Colore)



13 - Nero opaco
(Tutto Colore)

Colore RAL a scelta

Il colore RAL è realizzato nella versione Tutto Colore.

Minimo d'ordine: 3 pezzi. Al di sotto dei 3 pezzi contributo fisso di 100,00 € **NETTI**.

Tempi di consegna **8 / 10 settimane** dalla conferma dell'ordine.

* Per eventuali ricambi, accessori, articoli vari e prolunghe consultare le relative sezioni del listino

VITONI CERAMICI DA 1/4 DI GIRO

Gruppo lavabo 3 fori*_interasse bocca 11,5 cm***0504**

CON SCARICO

Gruppo lavabo monoforo*_interasse bocca 11,5 cm***0556F**

CON SCARICO

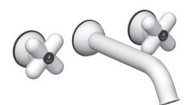
Gruppo lavabo da parete*_interasse bocca 20 cm***0511B+R010A**

SENZA SCARICO

Gruppo bidet monoforo*_interasse bocca 12 cm***0562F**

CON SCARICO

Lavello cucina : tavola sinottica

VITONI CERAMICI DA 1/4 DI GIRO

Gruppo lavello cucina monoforo*_interasse bocca 18 cm***0550F**

SENZA SCARICO

Art. 0504

leadØfree

Gruppo lavabo 3 fori

- interasse bocca 11,5 cm
- maniglie
- limitatore di portata 5 l/min a 3 bar
- vitone ceramico 90°
- flessibili di alimentazione
- CON SCARICO a pressione

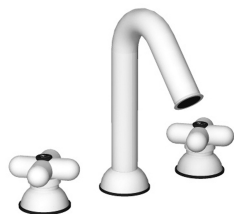

Nero Opaco 60 13 0504
 Bianco Opaco 60 29 0504
 Rosso - Cromo 60 06 050402
 Colore RAL a scelta 60 __ 0504

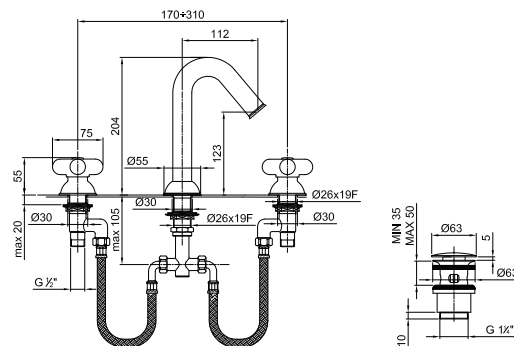

Art. 0556F

Gruppo lavabo monoforo

- interasse bocca 11,5 cm
- maniglie
- limitatore di portata 5 l/min a 3 bar
- vitone ceramico 90°
- flessibili di alimentazione
- CON SCARICO a pressione



Nero Opaco 60 13 0556F
 Bianco Opaco 60 29 0556F
 Rosso - Cromo 60 06 0556F02
 Colore RAL a scelta 60 __ 0556F

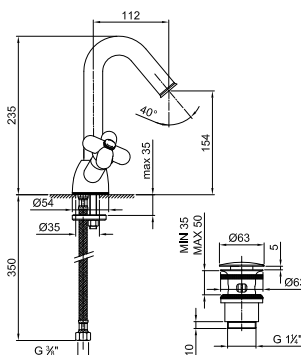

leadØfree

Gruppo lavabo da parete

- interasse bocca 20 cm
- maniglie
- limitatore di portata 5 l/min a 3 bar
- vitone ceramico 90°
- ingressi da 1/2"
- SENZA SCARICO

Art. 0511B

External piece

Nero Opaco 60 13 0511B
 Bianco Opaco 60 29 0511B
 Rosso - Cromo 60 06 0511B02
 Colore RAL a scelta 60 __ 0511B

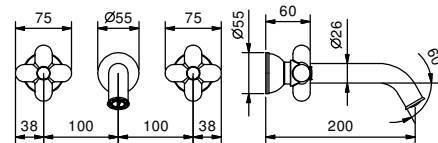
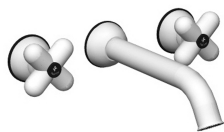

Art. R010A

Built-in piece

44 00 R010A

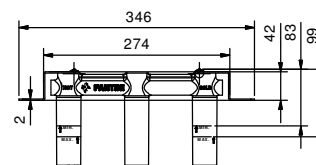
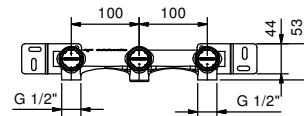

TOTAL PRICE

Nero Opaco
 Bianco Opaco
 Rosso - Cromo
 Colore RAL a scelta

Art. 0562F

Gruppo bidet monoforo

- interasse bocca 12 cm
- maniglie
- limitatore di portata 5 l/min a 3 bar
- vitone ceramico 90°
- aeratore snodato
- flessibili di alimentazione
- CON SCARICO



Nero Opaco	60 13 0562F
Bianco Opaco	60 29 0562F
Rosso - Cromo	60 06 0562F02
Colore RAL a scelta	60 _ 0562F

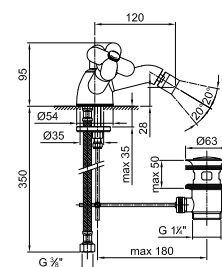

CARTUCCIA PROGRESSIVA

Miscelatore doccia incasso

_ingressi da 1/2"



0384B+0384A

2 uscite

CARTUCCIA TERMOSTATICA

Miscelatore doccia incasso

_ingressi da 3/4"



0600B+3900A



0690B+6090A

rubinetto di arresto

Deviatore incasso

_ingressi da 1/2"



0676B+D276A

2 uscite



0676B+D277A

3 uscite

Miscelatore doccia incasso

_ingressi da 3/4"



0601B+6001A

1 uscita



0602B+6002A

2 uscite



0603B+6003A

3 uscite

Miscelatore vasca/doccia incasso

- maniglie
- deviatore a rotazione con chiusura a **2 uscite**
- doccetta FIT
- presa acqua con supporto per doccetta
- flessibile PVC 150 cm
- ingressi da 1/2"
- isolamento acustico

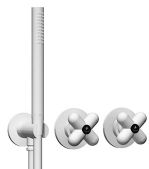
Art. 0384B**External piece**

Nero Opaco	60 13 0384B
Bianco Opaco	60 29 0384B
Rosso - Cromo	60 06 0384B02
Colore RAL a scelta	60 _ 0384B

Art. 0384A**Built-in piece**

22 00 0384A

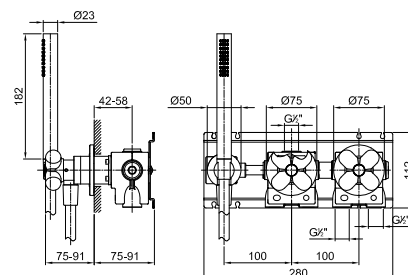
**TOTAL PRICE**

Nero Opaco
 Bianco Opaco
 Rosso - Cromo
 Colore RAL a scelta

Miscelatore termostatico doccia incasso 3/4"

- maniglia
- ingressi da 3/4"
- isolamento acustico
- senza rubinetto di arresto **da ordinare separatamente**

N.B. Il miscelatore deve sempre essere ordinato con il rubinetto di arresto art. 0690B+6090A o con il deviatore 0676B+D277A / 0676B+D276A

Art. 0600B**External piece**

Nero Opaco	60 13 0600B
Bianco Opaco	60 29 0600B
Rosso - Cromo	60 06 0600B02
Colore RAL a scelta	60 __ 0600B

Art. 3900A**Built-in piece**

19 00 3900A

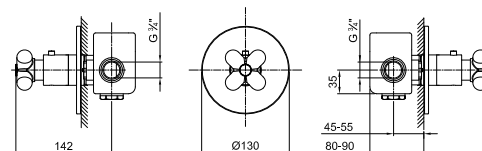
**TOTAL PRICE**

Nero Opaco
Bianco Opaco
Rosso - Cromo
Colore RAL a scelta

Rubinetto di arresto 3/4"

- maniglia
- vitone ceramico 90°
- ingressi da 3/4"
- isolamento acustico

Art. 0690B**External piece**

Nero Opaco	60 13 0690B
Bianco Opaco	60 29 0690B
Rosso - Cromo	60 06 0690B02
Colore RAL a scelta	60 __ 0690B

Art. 6090A**Built-in piece**

19 00 6090A

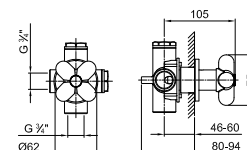
**TOTAL PRICE**

Nero Opaco
Bianco Opaco
Rosso - Cromo
Colore RAL a scelta

Deviatore incasso 2 uscite 1/2"

- maniglia
- deviatore a rotazione con chiusura a **2 uscite**
- con chiusura
- ingresso da 1/2"

Art. 0676B**External piece**

Nero Opaco	60 13 0676B
Bianco Opaco	60 29 0676B
Rosso - Cromo	60 06 0676B02
Colore RAL a scelta	60 __ 0676B

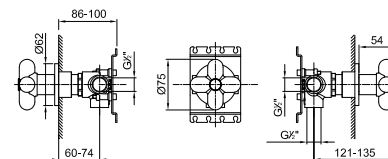
**Art. D276A****Built-in piece**

19 00 D276A

TOTAL PRICE

Nero Opaco
Bianco Opaco
Rosso - Cromo
Colore RAL a scelta

Deviatore incasso 3 uscite 1/2"

- maniglia
- deviatore a rotazione con chiusura a **3 uscite**
- con chiusura
- ingresso da 1/2"

Art. 0676B**External piece**

Nero Opaco	60 13 0676B
Bianco Opaco	60 29 0676B
Rosso - Cromo	60 06 0676B02
Colore RAL a scelta	60 __ 0676B

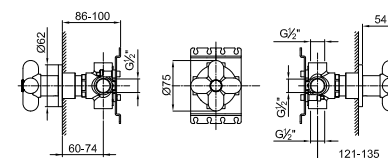
**Art. D277A****Built-in piece**

19 00 D277A

TOTAL PRICE

Nero Opaco
Bianco Opaco
Rosso - Cromo
Colore RAL a scelta

Miscelatore termostatico doccia incasso 3/4"

- 1 uscita da 3/4"
- maniglie
- ingressi da 3/4"
- isolamento acustico

Art. 0601B**External piece**

Nero Opaco	60 13 0601B
Bianco Opaco	60 29 0601B
Rosso - Cromo	60 06 0601B02
Colore RAL a scelta	60 __ 0601B

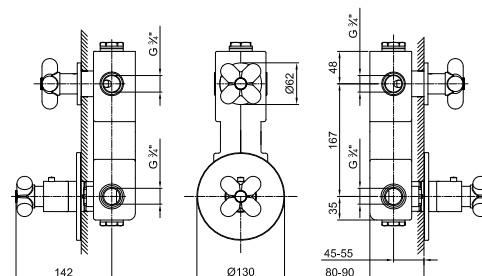
**Art. 6001A****Built-in piece**

19 00 6001A

**TOTAL PRICE**

Nero Opaco
Bianco Opaco
Rosso - Cromo
Colore RAL a scelta

Miscelatore termostatico doccia incasso 3/4"

- 2 uscite da 3/4"
- maniglie
- ingressi da 3/4"
- isolamento acustico

Art. 0602B**External piece**

Nero Opaco	60 13 0602B
Bianco Opaco	60 29 0602B
Rosso - Cromo	60 06 0602B02
Colore RAL a scelta	60 __ 0602B

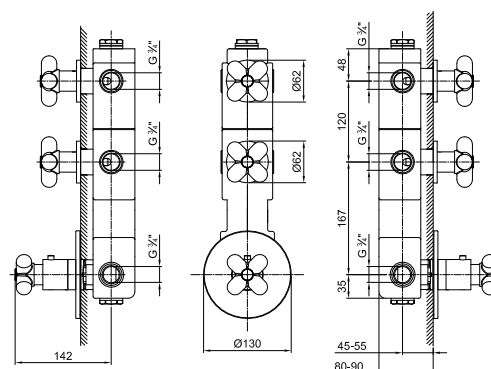
**Art. 6002A****Built-in piece**

19 00 6002A

**TOTAL PRICE**

Nero Opaco
Bianco Opaco
Rosso - Cromo
Colore RAL a scelta

Miscelatore termostatico doccia incasso 3/4"

- 3 uscite da 3/4"
- maniglie
- ingressi da 3/4"
- isolamento acustico

Art. 0603B**External piece**

Nero Opaco	60 13 0603B
Bianco Opaco	60 29 0603B
Rosso - Cromo	60 06 0603B02
Colore RAL a scelta	60 _ 0603B

Art. 6003A**Built-in piece**

19 00 6003A

TOTAL PRICE

Nero Opaco
Bianco Opaco
Rosso - Cromo
Colore RAL a scelta

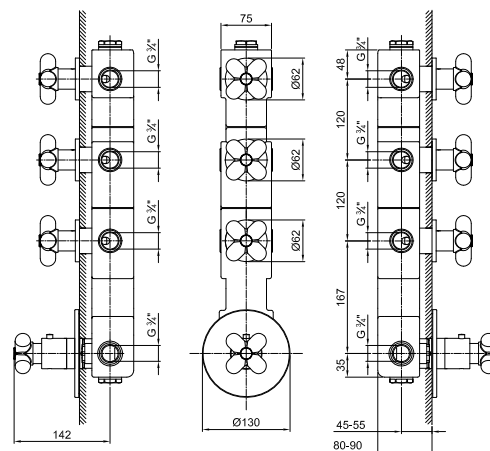

Art. 9230**Soffione a pioggia**

- Ø 20 cm
- materiale di base: ottone
- limitatore di portata 12 l/min a 3 bar
- sistema anticalcare
- ingresso da 1/2"
- valvola di non ritorno

N.B. Condizioni necessarie per il corretto funzionamento: Portata min.: 10 l/min

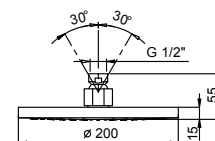
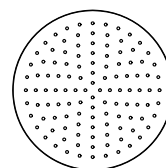

Nero Opaco	86 13 9230
Bianco Opaco	86 29 9230
Rosso	86 06 9230
Colore RAL a scelta	86 __ 9230

Art. 8027**Braccio doccia**

- lunghezza 30 cm
- rosone tondo
- per installazione a parete
- ingresso da 1/2"

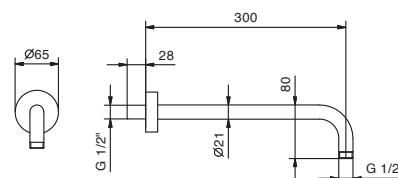

Nero Opaco	86 13 8027
Bianco Opaco	86 29 8027
Rosso - Cromo	86 06 802702
Colore RAL a scelta	86 __ 8027

**OPTIONAL Parte da incasso per cartongesso****Art. W046**

91 00 W046

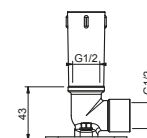
**Art. 8028****Braccio doccia**

- lunghezza 45 cm
- rosone tondo
- per installazione a parete
- ingresso da 1/2"

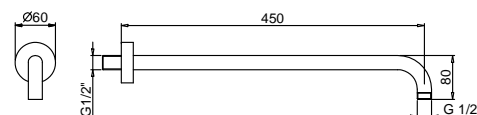

Nero Opaco	86 13 8028
Bianco Opaco	86 29 8028
Rosso - Cromo	86 06 802802
Colore RAL a scelta	86 __ 8028

**OPTIONAL Parte da incasso per cartongesso****Art. W046**

91 00 W046

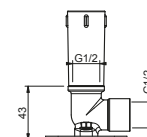

Art. 9236**Braccio doccia**

- lunghezza 25 cm
- rosone tondo
- per installazione a soffitto
- ingresso da 1/2"

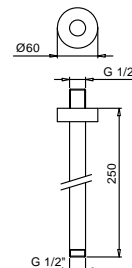

Nero Opaco	86 13 9236
Bianco Opaco	86 29 9236
Rosso - Cromo	86 06 923602
Colore RAL a scelta	86 __ 9236

**OPTIONAL Parte da incasso per cartongesso****Art. W046**

91 00 W046

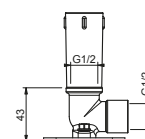
**Art. 9237****Braccio doccia**

- lunghezza 45 cm
- rosone tondo
- per installazione a soffitto
- ingresso da 1/2"

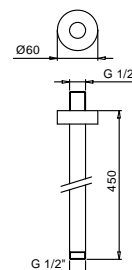

Nero Opaco	86 13 9237
Bianco Opaco	86 29 9237
Rosso - Cromo	86 06 923702
Colore RAL a scelta	86 __ 9237

**OPTIONAL Parte da incasso per cartongesso****Art. W046**

91 00 W046

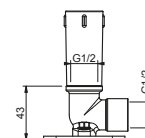
**Art. 8783****Doccetta**

- FIT
- materiale di base: ottone
- limitatore di portata 9 l/min
- sistema anticalcare
- valvola di non ritorno



Nero Opaco	90 13 8783
Bianco Opaco	90 29 8783
Rosso	90 06 8783

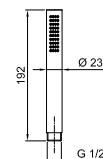

Art. 9249**Doccetta**

- doccetta SLIM
- limitatore di portata 9 l/min
- sistema anticalcare
- valvola di non ritorno

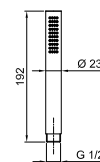

Colore RAL a scelta 90 __ 9249

Art. 8711**Doccetta**

- I BALOCCHI
- sistema anticalcare
- valvola di non ritorno
- limitatore di portata 9 l/min

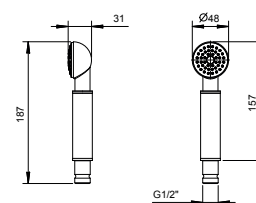

Nero Opaco 90 13 8711
 Bianco Opaco 90 29 8711
 Rosso - Cromo 90 06 871102
 Colore RAL a scelta 90 __ 8711

Art. 9323**Preso acqua**

- rosone tondo
- supporto doccetta fisso
- innesto per flessibile con calotta conica

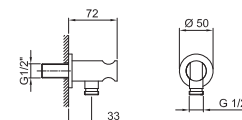

Nero Opaco 91 13 9323
 Bianco Opaco 91 29 9323
 Colore RAL a scelta 91 __ 9323

Art. 7034**Preso acqua**

- rosone tondo
- senza supporto doccetta

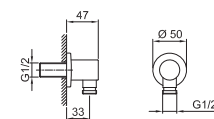

Nero Opaco 91 13 7034
 Bianco Opaco 91 29 7034
 Colore RAL a scelta 91 __ 7034

Art. 9349**Flessibile**

- materiale di base: PVC
- 150 cm
- 1/2" conico x 1/2" conico

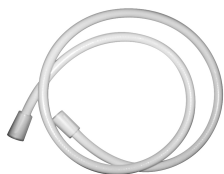

Cromo	90 02 9349
Nero Opaco	90 13 9349
Bianco Crema	90 26 9349

Art. 9193**Flessibile**

- materiale di base: ottone
- 150 cm
- Ø 15 mm
- 1/2" conico x 1/2" conico



Cromo	90 02 9193
-------	------------

Art. 9671**Flessibile**

- materiale di base: PVC
- 200 cm
- 1/2" conico x 1/2" conico

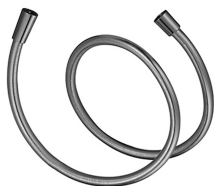

Cromo	90 02 9671
Nero Opaco	90 13 9671
Bianco Crema	90 26 9671

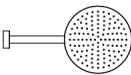
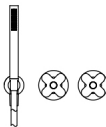
Composizione.1	art.	description	finish	
	9230	Soffione a pioggia	13	Nero Opaco
	0384B+0384A	Miscelatore vasca/doccia incasso	29	Bianco Opaco
	8027	Braccio doccia	—	Colore RAL a scelta
				

DOCCIA : composizioni cartuccia termostatica

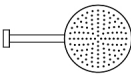
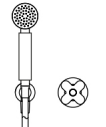
Composizione.1	art.	description	finish	
	9230	Soffione a pioggia	13	Nero Opaco
	9349	Flessibile	29	Bianco Opaco
	0676B+D276A	Deviatore incasso 2 uscite 1/2"		
	8027	Braccio doccia		
	0600B+3900A	Miscelatore termostatico doccia incasso 3/4"		
	9323	Presacqua		
	8711	Doccetta		

VITONI CERAMICI DA 1/4 DI GIRO

Gruppo vasca esterno



0515

2 uscite

Art. 0515

Gruppo vasca esterno

- interasse bocca 15,5 cm
- maniglie
- deviatore a **2 uscite**
- doccetta I BALOCCHI
- supporto doccetta
- flessibile PVC 150 cm
- vitone ceramico 90°

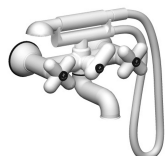

Nero Opaco	60 13 0515
Bianco Opaco	60 29 0515
Rosso - Cromo	60 06 051502
Colore RAL a scelta	60 __ 0515

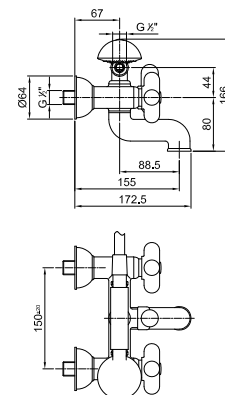

VASCA : bocche

Art. 0545

Bocca vasca da parete

- interasse bocca 20 cm
- ingresso da 1/2"



Nero Opaco	60 13 0545
Bianco Opaco	60 29 0545
Rosso - Cromo	60 06 054502
Colore RAL a scelta	60 __ 0545

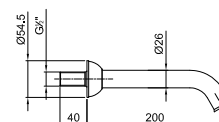

Art. 0550F**Gruppo lavello cucina monoforo**

- interasse bocca 18 cm
- maniglie
- bocca girevole
- limitatore di portata 8 l/min a 3 bar
- flessibili di alimentazione
- SENZA SCARICO



Nero Opaco	60 13 0550F
Bianco Opaco	60 29 0550F
Rosso - Cromo	60 06 0550F02
Colore RAL a scelta	60 __ 0550F

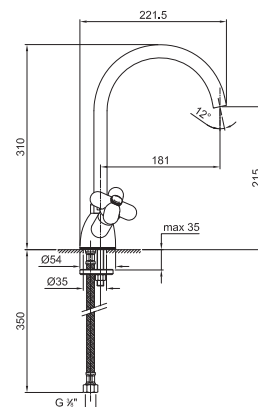

Art. 8434**Scarico**

- 1" 1/4
- tappo a pressione
- per lavabi senza troppo pieno
- per lavabi con troppo pieno
- universale



N.B. elenco completo delle finiture nella sezione articoli vari in fondo al listino

Nero Opaco	91 13 8434
Bianco Opaco	91 29 8434
Colore RAL a scelta	91 _ 8434

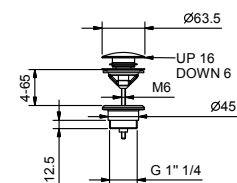
**Art. 8435****Scarico**

- 1" 1/4
- per lavabi senza troppo pieno
- per lavabi con troppo pieno
- uscita libera
- universale



N.B. elenco completo delle finiture nella sezione articoli vari in fondo al listino

Nero Opaco	91 13 8435
Bianco Opaco	91 29 8435
Colore RAL a scelta	91 _ 8435

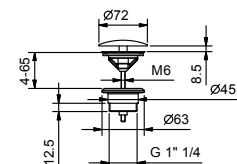
**Art. 9234****Sifone a bottiglia**

- 1" 1/4
- per lavabo



N.B. elenco completo delle finiture nella sezione articoli vari in fondo al listino

Nero Opaco	91 13 9234
Bianco Opaco	91 29 9234
Colore RAL a scelta	91 _ 9234

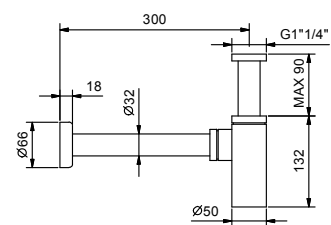
**Art. 8364****Coppia di rubinetti filtro**

- con chiusura
- filtro ispezionabile
- ingresso da 1/2"



N.B. elenco completo delle finiture nella sezione articoli vari in fondo al listino

Nero Opaco	91 13 8364
Bianco Opaco	91 29 8364
Colore RAL a scelta	91 _ 8364

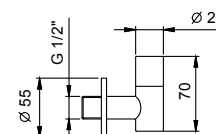

Art. 8402**Placca di comando per cassette di scarico**

- materiale di base: acciaio
- comandi a rilievo
- con pulsanti tondi
- compatibile con GEBERIT SIGMA8, SIGMA12
- senza fissaggi a vista



N.B. elenco completo delle finiture nella sezione articoli vari in fondo al listino

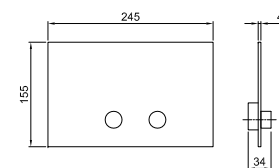

Acciaio lucido 91 38 8402
Nero Opaco 91 13 8402

Art. 8403**Placca di comando per cassette di scarico**

- materiale di base: acciaio
- comandi a filo
- con pulsanti quadri
- compatibile con GEBERIT SIGMA8, SIGMA12
- senza fissaggi a vista



N.B. elenco completo delle finiture nella sezione articoli vari in fondo al listino

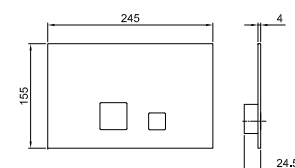

Acciaio lucido 91 38 8403
Nero Opaco 91 13 8403

Art. W001**Colonna scarico vasca**

- con maniglia
- CON SCARICO



N.B. elenco completo delle finiture nella sezione articoli vari in fondo al listino

Nero Opaco 91 13 W001
Bianco Opaco 91 29 W001
Colore RAL a scelta 91 _ W001

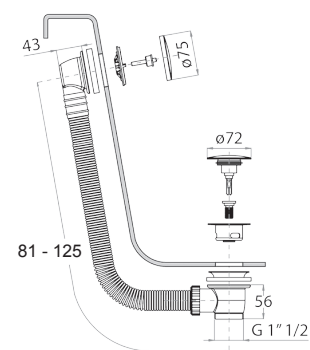
**Art. W002****Colonna scarico vasca**

- con maniglia
- erogazione dal troppo pieno
- CON SCARICO



N.B. elenco completo delle finiture nella sezione articoli vari in fondo al listino

Nero Opaco 91 13 W002
Bianco Opaco 91 29 W002
Colore RAL a scelta 91 _ W002

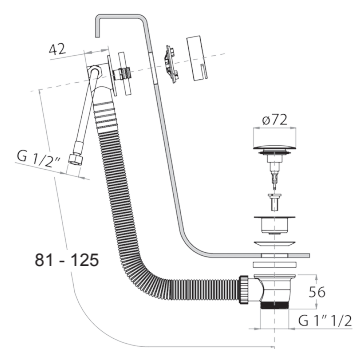



Fratelli Fantini Spa

Pella (Novara), Italy - t. +39 0322 918411

fantini@fantini.it - www.fantini.it