

ICONA DECO

TECHNISCHES HANDBUCH

ICONA DECO

Design Vincent Van Duysen



P5 R107W

WASCHTISCH	s. 194
BIDET	s. 197
DUSCHE	s. 201
BADEWANNE	s. 215
Badewanne - Auslauf	s. 218
KÜCHE	s. 219
ZUBEHÖR	s. 220

Technische Hinweise

Die Serie ICONA DECO wird grundsätzlich MIT GRIFF geliefert.

Wasch- und Bidet-Mischer sind mit einem **Perlator** bis zu 5 l/min ausgestattet.

BOHRLÖCHER FÜR ARMATUREN IN WASCHTISCHEN:

- Einloch-Waschtisch und Bidetmischer.



- 3-Loch-Waschtischarmaturen.

Art. R107

Art. R106

Art. R104

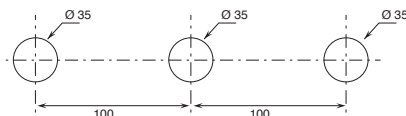

Der Duschthermostat 3/4" steht zur Verfügung:

- Art. R831B+D331A - 1 Ausgang

- Art. R872B+D372A - 2 Ausgänge

- Art. R873B+D373A - 3 Ausgänge

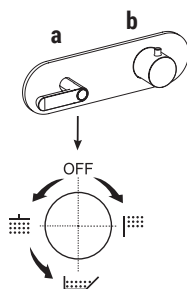

BEISPIEL:

Art. R873B+D373A

a) Drehumsteller mit Absperrung - Ausgehend von der Mittelstellung aktivieren Sie durch Drehen nach rechts den 1. Ausgang. Durch Drehen nach links aktivieren Sie den 2. und in der Folge den 3. Ausgang.

b) Temperatureinstellung

Basismaterial: MESSING

Oberflächen:

- 02 Chrom
- 13 Schwarz Matt (RAL 9005)
- 95 Polished Nickel PVD
- P5 Matt Gun Metal PVD
- P6 Matt British Gold PVD
- P9 Matt Copper PVD
- Q7 Pure Brass PVD
- Q8 Raw Metal PVD

* Ersatzteile, Zubehöre, verschiedene Artikel und Verlängerungen können in bestimmten Preislistenanteilen eingesehen werden

90° KERAMIKOBERTEIL

3-Loch-Waschtischmischer*_Achsabstand Auslauf 16 cm*

R107W
OHNE ABLAUF

R107
MIT ABLAUF

3-Loch-Waschtischmischer*_Achsabstand Auslauf 14,5 cm*

R106W
OHNE ABLAUF

R106
MIT ABLAUF

3-Loch-Waschtischmischer*_Achsabstand Auslauf 14,5 cm*

R104W
OHNE ABLAUF

R104
MIT ABLAUF

Wandwaschtischmischer*_Achsabstand Auslauf 15 cm*

R110B+R010A
OHNE ABLAUF

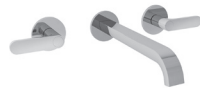
Wandwaschtischmischer*_Achsabstand Auslauf 20 cm*

R113B+R010A
OHNE ABLAUF

1-Loch-Bidetmischer 3 fori*_Achsabstand Auslauf 13 cm*

R108W
OHNE ABLAUF

R108
MIT ABLAUF

1-Loch-Bidetmischer*_Achsabstand Auslauf 13 cm*

R111B+R011A
comandi remoti a parete
MIT ABLAUF

Bidet- Einlauf*_Achsabstand Auslauf 13 cm*

Z344

Küchen : Übersichtstabelle

90° KERAMIKOBERTEIL

Küchemischer*_Achsabstand Auslauf 21,5 cm*

R151
OHNE ABLAUF

R107W
lead \varnothing free



3-Loch-Waschtischmischer

- Achsabstand Auslauf 16 cm
- Griffe
- Wasserdurchflussbegrenzer auf 5 l/min bei 3 bar
- 90° Keramikventil
- Versorgungsleitung/schläuche
- OHNE ABLAUF

Chrom	53 02 R107W
Schwarz matt	53 13 R107W
Polished Nickel PVD	53 95 R107W
Matt Gun Metal PVD	53 P5 R107W
Matt British Gold PVD	53 P6 R107W
Matt Copper PVD	53 P9 R107W
Pure Brass PVD	53 Q7 R107W
Raw Metal PVD	53 Q8 R107W

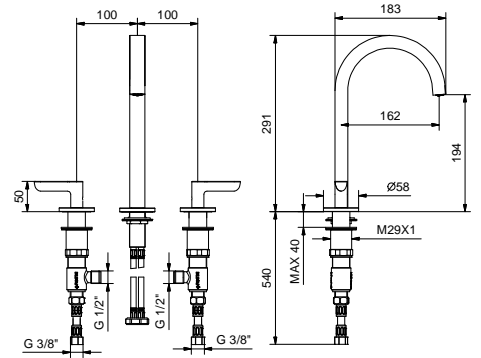

R107
lead \varnothing free



3-Loch-Waschtischmischer

- Achsabstand Auslauf 16 cm
- Griffe
- Wasserdurchflussbegrenzer auf 5 l/min bei 3 bar
- 90° Keramikventil
- Versorgungsleitung/schläuche
- ABLAUF mit Druckverschluss

Chrom	53 02 R107
Schwarz matt	53 13 R107
Polished Nickel PVD	53 95 R107
Matt Gun Metal PVD	53 P5 R107
Matt British Gold PVD	53 P6 R107
Matt Copper PVD	53 P9 R107
Pure Brass PVD	53 Q7 R107
Raw Metal PVD	53 Q8 R107

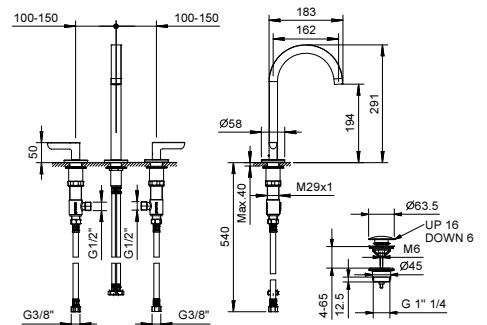

R106W
lead \varnothing free



3-Loch-Waschtischmischer

- Achsabstand Auslauf 14,5 cm
- Griffe
- Wasserdurchflussbegrenzer auf 5 l/min bei 3 bar
- 90° Keramikventil
- Versorgungsleitung/schläuche
- OHNE ABLAUF

Chrom	53 02 R106W
Schwarz matt	53 13 R106W
Polished Nickel PVD	53 95 R106W
Matt Gun Metal PVD	53 P5 R106W
Matt British Gold PVD	53 P6 R106W
Matt Copper PVD	53 P9 R106W
Pure Brass PVD	53 Q7 R106W
Raw Metal PVD	53 Q8 R106W

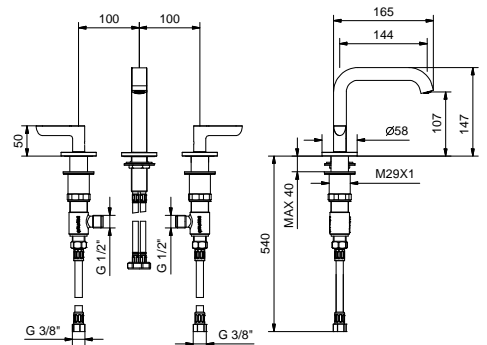

R106
lead \varnothing free



3-Loch-Waschtischmischer

- Achsabstand Auslauf 14,5 cm
- Griffe
- Wasserdurchflussbegrenzer auf 5 l/min bei 3 bar
- 90° Keramikventil
- Versorgungsleitung/schläuche
- ABLAUF mit Druckverschluss

Chrom	53 02 R106
Schwarz matt	53 13 R106
Polished Nickel PVD	53 95 R106
Matt Gun Metal PVD	53 P5 R106
Matt British Gold PVD	53 P6 R106
Matt Copper PVD	53 P9 R106
Pure Brass PVD	53 Q7 R106
Raw Metal PVD	53 Q8 R106

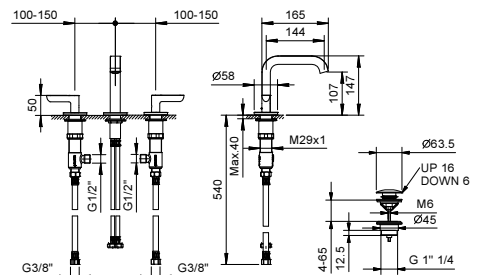

R104W
lead \emptyset free

3-Loch-Waschtischmischer

- Achsabstand Auslauf 14,5 cm
- Griffe
- Wasserdurchflussbegrenzer auf 5 l/min bei 3 bar
- 90° Keramikventil
- Versorgungsleitung/schläuche
- OHNE ABLAUF



Chrom	53 02 R104W
Schwarz matt	53 13 R104W
Polished Nickel PVD	53 95 R104W
Matt Gun Metal PVD	53 P5 R104W
Matt British Gold PVD	53 P6 R104W
Matt Copper PVD	53 P9 R104W
Pure Brass PVD	53 Q7 R104W
Raw Metal PVD	53 Q8 R104W

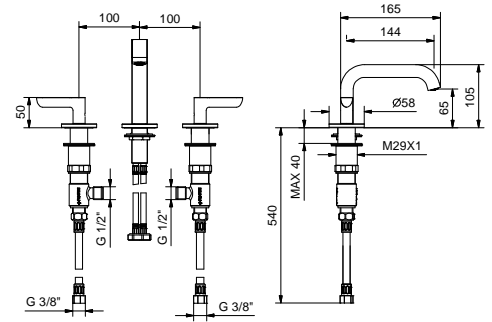

R104
lead \emptyset free

3-Loch-Waschtischmischer

- Achsabstand Auslauf 14,5 cm
- Griffe
- Wasserdurchflussbegrenzer auf 5 l/min bei 3 bar
- 90° Keramikventil
- Versorgungsleitung/schläuche
- ABLAUF mit Druckverschluss



Chrom	53 02 R104
Schwarz matt	53 13 R104
Polished Nickel PVD	53 95 R104
Matt Gun Metal PVD	53 P5 R104
Matt British Gold PVD	53 P6 R104
Matt Copper PVD	53 P9 R104
Pure Brass PVD	53 Q7 R104
Raw Metal PVD	53 Q8 R104

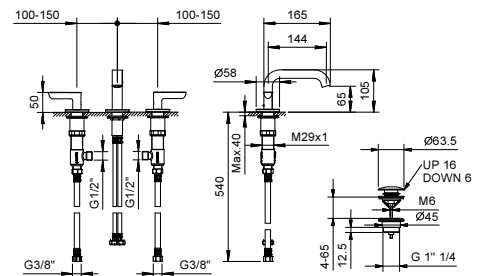

lead \emptyset free

Wandwaschtischmischer

- Achsabstand Auslauf 15 cm
- Griffe
- Wasserdurchflussbegrenzer auf 5 l/min bei 3 bar
- 90° Keramikventil
- 1/2" Eingänge
- OHNE ABLAUF

R110B

AP-Teil

Chrom	53 02 R110B
Schwarz matt	53 13 R110B
Polished Nickel PVD	53 95 R110B
Matt Gun Metal PVD	53 P5 R110B
Matt British Gold PVD	53 P6 R110B
Matt Copper PVD	53 P9 R110B
Pure Brass PVD	53 Q7 R110B
Raw Metal PVD	53 Q8 R110B

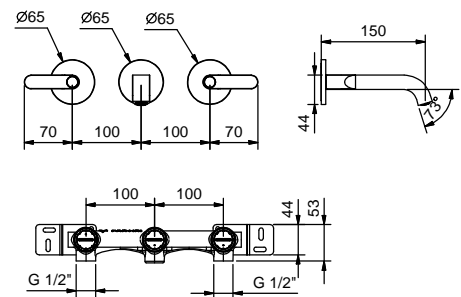
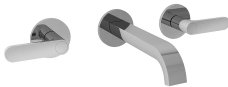

R010A

UP-Teil

44 00 R010A

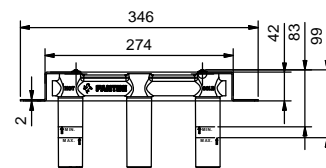

lead \varnothing free

Wandwaschtischmischer

- Achsabstand Auslauf 20 cm
- Griffe
- Wasserdurchflussbegrenzer auf 5 l/min bei 3 bar
- 90° Keramikventil
- 1/2" Eingänge
- OHNE ABLAUF

R113B

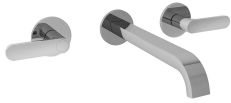

AP-Teil

Chrom	53 02 R113B
Schwarz matt	53 13 R113B
Polished Nickel PVD	53 95 R113B
Matt Gun Metal PVD	53 P5 R113B
Matt British Gold PVD	53 P6 R113B
Matt Copper PVD	53 P9 R113B
Pure Brass PVD	53 Q7 R113B
Raw Metal PVD	53 Q8 R113B

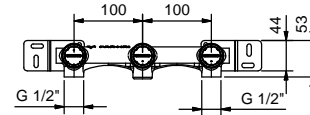
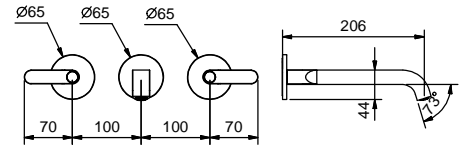

R010A



UP-Teil

44 00 R010A

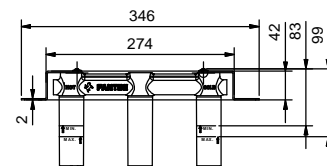

R108W

3-Loch-Bidetmischer

- Achsabstand Auslauf 13 cm
- Wasserdurchflussbegrenzer auf 5 l/min bei 3 bar
- Griffe
- 90° Keramikventil
- Perlator mit Gelenk
- Versorgungsleitung/schläuche
- OHNE ABLAUF



Chrom	53 02 R108W
Schwarz matt	53 13 R108W
Polished Nickel PVD	53 95 R108W
Matt Gun Metal PVD	53 P5 R108W
Matt British Gold PVD	53 P6 R108W
Matt Copper PVD	53 P9 R108W
Pure Brass PVD	53 Q7 R108W
Raw Metal PVD	53 Q8 R108W

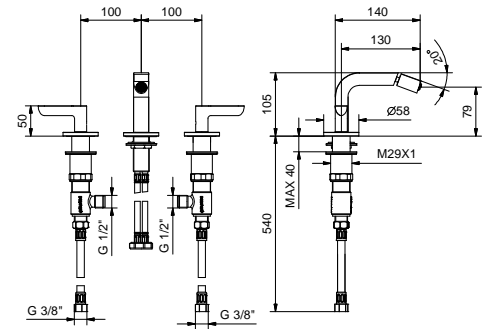

R108

3-Loch-Bidetmischer

- Achsabstand Auslauf 13 cm
- Wasserdurchflussbegrenzer auf 5 l/min bei 3 bar
- Griffe
- 90° Keramikventil
- Perlator mit Gelenk
- Versorgungsleitung/schläuche
- ABLAUF mit Druckverschluss



Chrom	53 02 R108
Schwarz matt	53 13 R108
Polished Nickel PVD	53 95 R108
Matt Gun Metal PVD	53 P5 R108
Matt British Gold PVD	53 P6 R108
Matt Copper PVD	53 P9 R108
Pure Brass PVD	53 Q7 R108
Raw Metal PVD	53 Q8 R108

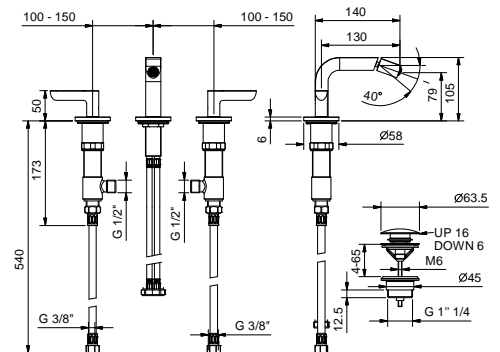

Z344

Bidet- Einlauf

- Achsabstand Auslauf 13 cm
- Wasserdurchflussbegrenzer auf 5 l/min bei 3 bar
- 1/2" Eingang



Chrom	53 02 Z344
Schwarz matt	53 13 Z344
Polished Nickel PVD	53 95 Z344
Matt Gun Metal PVD	53 P5 Z344
Matt British Gold PVD	53 P6 Z344
Matt Copper PVD	53 P9 Z344
Pure Brass PVD	53 Q7 Z344
Raw Metal PVD	53 Q8 Z344

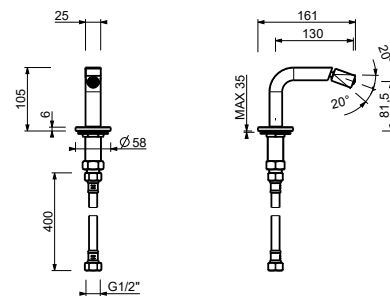

STANDARDKARTUSCHE

UP-Brausemischer

_1/2" Eingänge



R063B+M063A
1 Ausgang



R685B+M585A
2 Ausgänge



R685B+M685A
2 Ausgänge



R687B+M587A
3 Ausgänge



R687B+M687A
3 Ausgänge

THERMOSTATKARTUSCHE

UP-Brausemischer

_3/4" Eingänge



R831B+D331A
1 Ausgang



R872B+D372A
2 Ausgänge

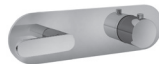

R873B+D373A
3 Ausgänge



R700B+D400A



R891B+D391A
Absperrventil

Duschstange mit Ap Mischer

_1/2" Eingänge



R429
2 Ausgänge

UP-Brausemischer

- Griff
- 1/2" **1 Ausgang**
- 1/2" Eingänge
- Schallschutz

R063B



AP-Teil

Chrom	53 02 R063B
Schwarz matt	53 13 R063B
Polished Nickel PVD	53 95 R063B
Matt Gun Metal PVD	53 P5 R063B
Matt British Gold PVD	53 P6 R063B
Matt Copper PVD	53 P9 R063B
Pure Brass PVD	53 Q7 R063B
Raw Metal PVD	53 Q8 R063B

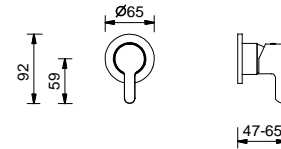

M063A



UP-Teil

44 00 M063A

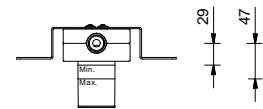
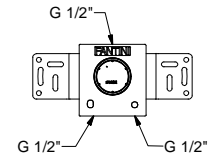

UP-Brausemischer

- Griffe
- Drehumsteller **2-Wege**
- 1/2" Eingänge
- Schallschutz
- nur für vertikale Montage

R685B



AP-Teil

Chrom	53 02 R685B
Schwarz matt	53 13 R685B
Polished Nickel PVD	53 95 R685B
Matt Gun Metal PVD	53 P5 R685B
Matt British Gold PVD	53 P6 R685B
Matt Copper PVD	53 P9 R685B
Pure Brass PVD	53 Q7 R685B
Raw Metal PVD	53 Q8 R685B

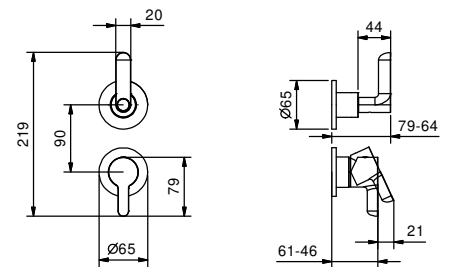

M585A



UP-Teil

44 00 M585A

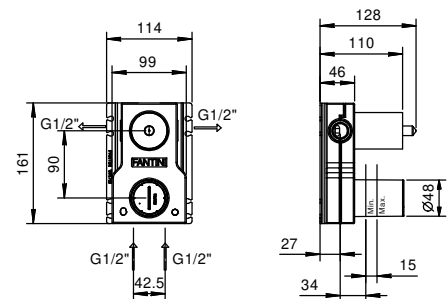

UP-Brausemischer

- Griffe
- Drehumsteller **2-Wege**
- 1/2" Eingänge
- Schallschutz
- nur für horizontale Montage

R685B



AP-Teil

Chrom	53 02 R685B
Schwarz matt	53 13 R685B
Polished Nickel PVD	53 95 R685B
Matt Gun Metal PVD	53 P5 R685B
Matt British Gold PVD	53 P6 R685B
Matt Copper PVD	53 P9 R685B
Pure Brass PVD	53 Q7 R685B
Raw Metal PVD	53 Q8 R685B

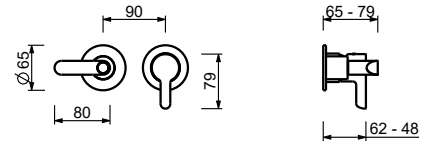

M685A

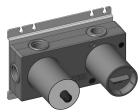

UP-Teil

44 00 M685A

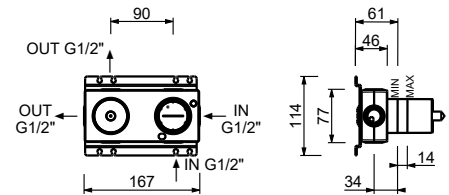

UP-Brauseemischer

- Griffe
- Drehumsteller **3-Wege**
- 1/2" Eingänge
- nur für vertikale Montage
- Schallschutz

R687B



AP-Teil

Chrom	53 02 R687B
Schwarz matt	53 13 R687B
Polished Nickel PVD	53 95 R687B
Matt Gun Metal PVD	53 P5 R687B
Matt British Gold PVD	53 P6 R687B
Matt Copper PVD	53 P9 R687B
Pure Brass PVD	53 Q7 R687B
Raw Metal PVD	53 Q8 R687B

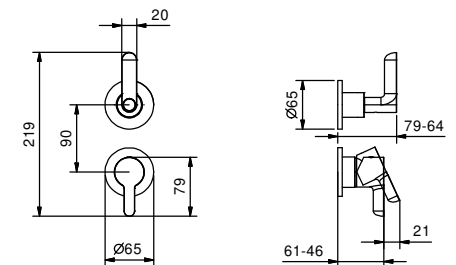

M587A



UP-Teil

44 00 M587A

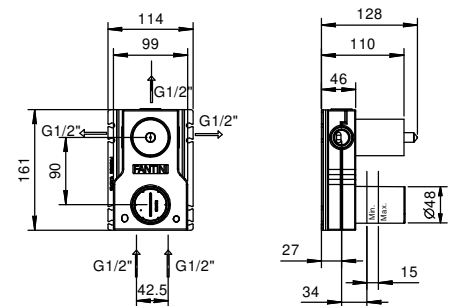

UP-Brausemischer

- Griffe
- Drehumsteller **3-Wege**
- 1/2" Eingänge
- Schallschutz
- nur für horizontale Montage

R687B

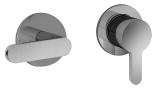

AP-Teil

Chrom	53 02 R687B
Schwarz matt	53 13 R687B
Polished Nickel PVD	53 95 R687B
Matt Gun Metal PVD	53 P5 R687B
Matt British Gold PVD	53 P6 R687B
Matt Copper PVD	53 P9 R687B
Pure Brass PVD	53 Q7 R687B
Raw Metal PVD	53 Q8 R687B

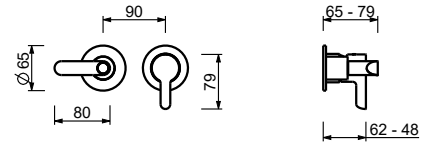

M687A

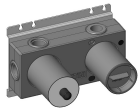

UP-Teil

44 00 M687A

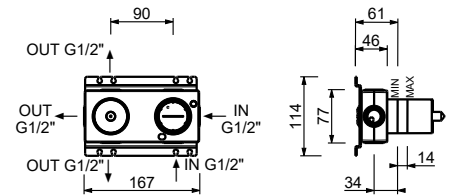

DUSCHE : Thermostatkartusche

R429

Duschstange mit Ap Mischer

- Griffe
- Drehumsteller **2-Wege** mit Absperrung
- Schlauch PVC 150 cm
- Handbrause
- Kopfbrause Ø 24 cm
- 1/2" Eingänge
- verstellbarer Brausehalter



Chrom	53 02 R429
Schwarz matt	53 13 R429
Polished Nickel PVD	53 95 R429
Matt Gun Metal PVD	53 P5 R429
Matt British Gold PVD	53 P6 R429
Matt Copper PVD	53 P9 R429

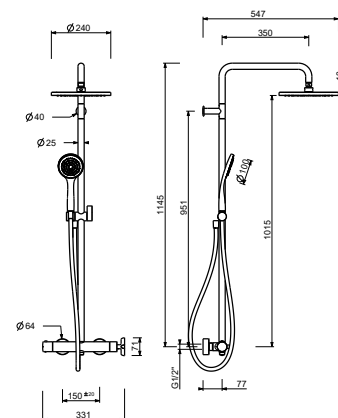

3/4" UP-Thermostatbrausemischer

- Griffe
- 1/2" **1 Ausgang**
- nur für horizontale Montage
- 3/4" Eingänge

R831B

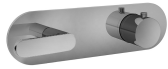

AP-Teil

Chrom	53 02 R831B
Schwarz matt	53 13 R831B
Polished Nickel PVD	53 95 R831B
Matt Gun Metal PVD	53 P5 R831B
Matt British Gold PVD	53 P6 R831B
Matt Copper PVD	53 P9 R831B
Pure Brass PVD	53 Q7 R831B
Raw Metal PVD	53 Q8 R831B

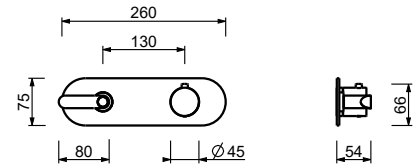

D331A



UP-Teil

19 00 D331A

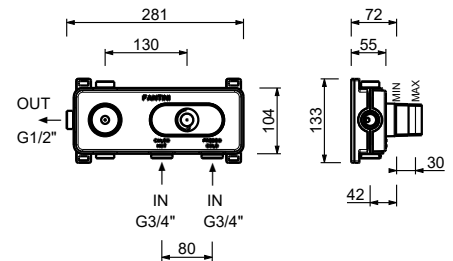

3/4" UP-Thermostatbrausemischer

- Griffe
- Drehumsteller **2-Wege** mit Absperrung
- nur für horizontale Montage
- 3/4" Eingänge

R872B

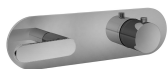

AP-Teil

Chrom	53 02 R872B
Schwarz matt	53 13 R872B
Polished Nickel PVD	53 95 R872B
Matt Gun Metal PVD	53 P5 R872B
Matt British Gold PVD	53 P6 R872B
Matt Copper PVD	53 P9 R872B
Pure Brass PVD	53 Q7 R872B
Raw Metal PVD	53 Q8 R872B

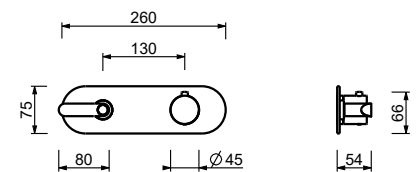

D372A



UP-Teil

19 00 D372A

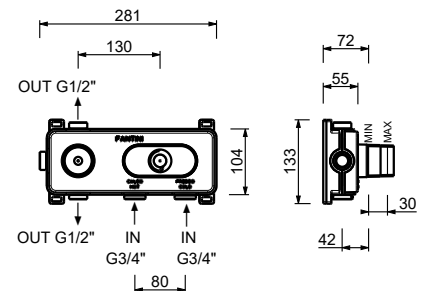

3/4" UP-Thermostatbrausemischer

- Griffe
- Drehumsteller **3-Wege** mit Absperrung
- nur für horizontale Montage
- 3/4" Eingänge

R873B

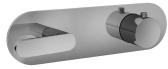

AP-Teil

Chrom	53 02 R873B
Schwarz matt	53 13 R873B
Polished Nickel PVD	53 95 R873B
Matt Gun Metal PVD	53 P5 R873B
Matt British Gold PVD	53 P6 R873B
Matt Copper PVD	53 P9 R873B
Pure Brass PVD	53 Q7 R873B
Raw Metal PVD	53 Q8 R873B

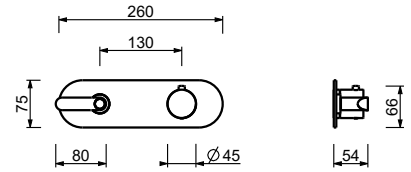

D373A



UP-Teil

19 00 D373A

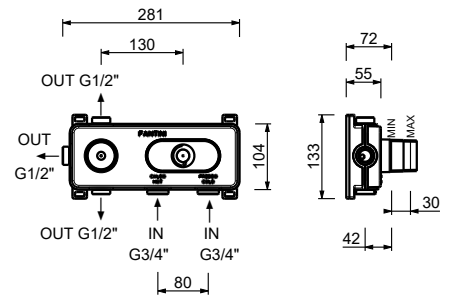

3/4" UP-Thermostatbrausemischer

- Griff
- 3/4" Eingänge
- Schallschutz
- ohne Absperrventil, **muss separat dazu bestellt werden**

Hinweis: Mischer muss immer mit Absperrventil R891B+D391A bestellt werden

R700B



AP-Teil

Chrom	87 02 R700B
Schwarz matt	87 13 R700B
Polished Nickel PVD	87 95 R700B
Matt Gun Metal PVD	87 P5 R700B
Matt British Gold PVD	87 P6 R700B
Matt Copper PVD	87 P9 R700B
Pure Brass PVD	87 Q7 R700B
Raw Metal PVD	87 Q8 R700B

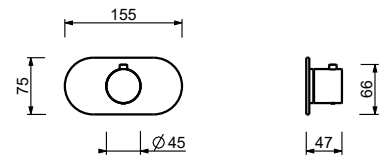

D400A



UP-Teil

19 00 D400A

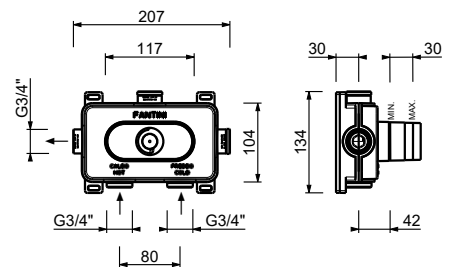

3/4" Absperrventil

- Griff
- 3/4" Eingänge
- Schallschutz
- 90° Keramikventil

R891B



AP-Teil

Chrom	53 02 R891B
Schwarz matt	53 13 R891B
Polished Nickel PVD	53 95 R891B
Matt Gun Metal PVD	53 P5 R891B
Matt British Gold PVD	53 P6 R891B
Matt Copper PVD	53 P9 R891B
Pure Brass PVD	53 Q7 R891B
Raw Metal PVD	53 Q8 R891B

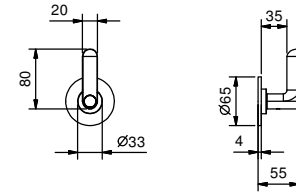

D391A



UP-Teil

19 00 D391A

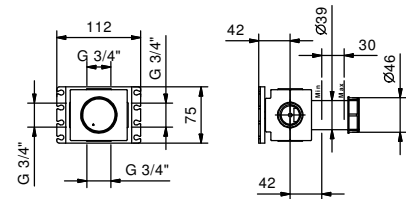

W213

OPTIONAL - "Easy Fix" System

- Platte und Verbindungen
- für einfache horizontale oder vertikale Thermostatmontage
 - für Montage Art D400A / D391A - **1 Ausgang**
 - für Montage Art D400A / D391A (2Stk) - **2 Ausgänge**

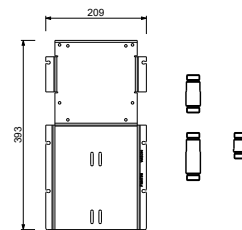

ESEMPI DI COMBINAZIONI - 1 USCITA



ESEMPI DI COMBINAZIONI - 2 USCITE



91 00 W213

W214**OPTIONAL - "Easy Fix" System**

Platte und Verbindungen

- für einfache horizontale oder vertikale Thermostatmontage
- für Montage Art D400A / D391A (3Stk) - **3 Ausgänge**

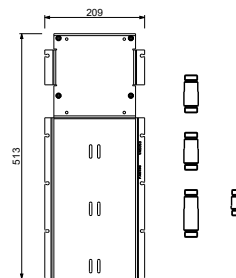
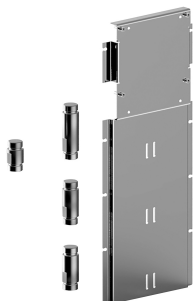
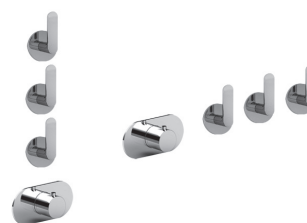
**ESEMPI DI COMBINAZIONI - 3 USCITE**

91 00 W214

8136

Regenkopfbrause

- Ø 20 cm
- Basismaterial: Messing
- Wasserdurchflussbegrenzer auf 12 l/min bei 3 bar
- Antikalksystem
- 1/2" Eingang
- Rückflussverhinderer

**Hinweis: Nötige Bedingungen für korrektes Funktionieren:
Mindestzufuhr: 10 l/min**

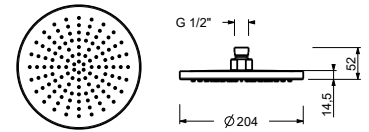

Chrom	86 02 8136
Schwarz matt	86 13 8136
Polished Nickel PVD	86 95 8136
Matt Gun Metal PVD	86 P5 8136
Matt British Gold PVD	86 P6 8136
Matt Copper PVD	86 P9 8136
Pure Brass PVD	86 Q7 8136
Raw Metal PVD	86 Q8 8136

9230

Regenkopfbrause

- Ø 20 cm
- Basismaterial: Messing
- Wasserdurchflussbegrenzer auf 12 l/min bei 3 bar
- Antikalksystem
- 1/2" Eingang
- Rückflussverhinderer

**Hinweis: Nötige Bedingungen für korrektes Funktionieren:
Mindestzufuhr: 10 l/min**

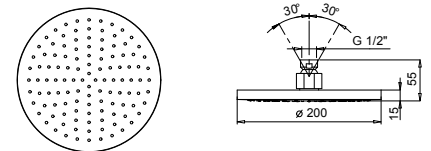
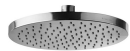

Chrom	86 02 9230
Schwarz matt	86 13 9230

8027

Brausearm

- Länge 30 cm
- runde Rosette
- Wandmontage
- 1/2" Eingang

Chrom	86 02 8027
Schwarz matt	86 13 8027
Polished Nickel PVD	86 95 8027
Matt Gun Metal PVD	86 P5 8027
Matt British Gold PVD	86 P6 8027
Matt Copper PVD	86 P9 8027
Pure Brass PVD	86 Q7 8027
Raw Metal PVD	86 Q8 8027

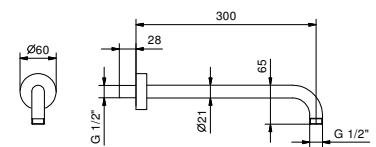

OPTIONAL: UP-Teil für Gipskarton

W046	91 00 W046
-------------	------------

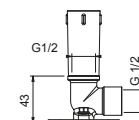

8137

Brausearm

- Länge 35 cm
- runde Rosette
- Wandmontage
- 1/2" Eingang

Chrom	86 02 8137
Schwarz matt	86 13 8137
Polished Nickel PVD	86 95 8137
Matt Gun Metal PVD	86 P5 8137
Matt British Gold PVD	86 P6 8137
Matt Copper PVD	86 P9 8137
Pure Brass PVD	86 Q7 8137
Raw Metal PVD	86 Q8 8137

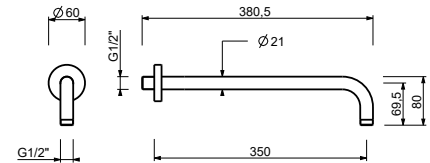

OPTIONAL: UP-Teil für Gipskarton

W046 91 00 W046

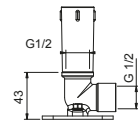

8028

Brausearm

- Länge 45 cm
- runde Rosette
- Wandmontage
- 1/2" Eingang

Chrom	86 02 8028
Schwarz matt	86 13 8028
Polished Nickel PVD	86 95 8028
Matt Gun Metal PVD	86 P5 8028
Matt British Gold PVD	86 P6 8028
Matt Copper PVD	86 P9 8028
Pure Brass PVD	86 Q7 8028
Raw Metal PVD	86 Q8 8028

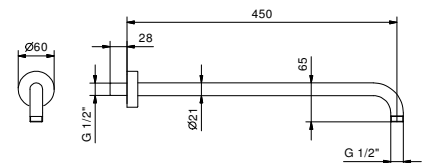

OPTIONAL: UP-Teil für Gipskarton

W046 91 00 W046

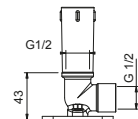

9236

Brausearm

- Länge 25 cm
- runde Rosette
- Deckenmontage
- 1/2" Eingang

Chrom	86 02 9236
Schwarz matt	86 13 9236
Polished Nickel PVD	86 95 9236
Matt Gun Metal PVD	86 P5 9236
Matt British Gold PVD	86 P6 9236
Matt Copper PVD	86 P9 9236
Pure Brass PVD	86 Q7 9236
Raw Metal PVD	86 Q8 9236

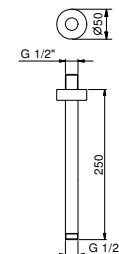

OPTIONAL: UP-Teil für Gipskarton

W046 91 00 W046

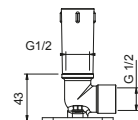

9237

Brausearm

- Länge 45 cm
- runde Rosette
- Deckenmontage
- 1/2" Eingang



Chrom	86 02 9237
Schwarz matt	86 13 9237
Polished Nickel PVD	86 95 9237
Matt Gun Metal PVD	86 P5 9237
Matt British Gold PVD	86 P6 9237
Matt Copper PVD	86 P9 9237
Pure Brass PVD	86 Q7 9237
Raw Metal PVD	86 Q8 9237

OPTIONAL: UP-Teil für Gipskarton**W046**

91 00 W046

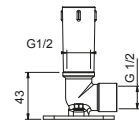
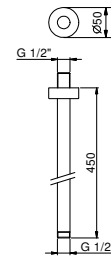

R043

Brausetset

- Handbrause ICONA
- Wandbogen mit Brausehalter
- runde Rosette
- Schlauch PVC 150 cm
- 1/2" Eingang



Chrom	53 02 R043
Schwarz matt	53 13 R043
Polished Nickel PVD	53 95 R043
Matt Gun Metal PVD	53 P5 R043
Matt British Gold PVD	53 P6 R043
Matt Copper PVD	53 P9 R043
Pure Brass PVD	53 Q7 R043
Raw Metal PVD	53 Q8 R043

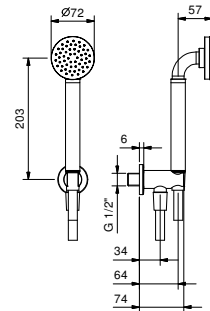

8938

Handbrause

- ICONA
- Durchflussbegrenzer auf 9 l/min
- Antikalksystem
- Rückflussverhinderer



Chrom	90 02 8938
Schwarz matt	90 13 8938
Polished Nickel PVD	90 95 8938
Matt Gun Metal PVD	90 P5 8938
Matt British Gold PVD	90 P6 8938
Matt Copper PVD	90 P9 8938
Pure Brass PVD	90 Q7 8938
Raw Metal PVD	90 Q8 8938

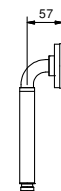
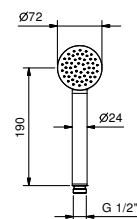

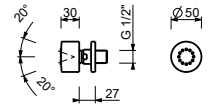

9248**Seitenkörperbrausen**

- Basismaterial: Messing
- verstellbar
- Antikalksystem
- 1/2" Eingang

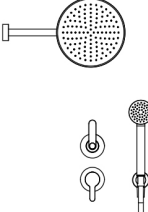
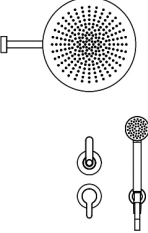
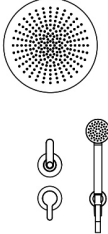

Chrom	86 02 9248
Schwarz matt	86 13 9248
Polished Nickel PVD	86 95 9248
Matt Gun Metal PVD	86 P5 9248
Matt British Gold PVD	86 P6 9248
Matt Copper PVD	86 P9 9248

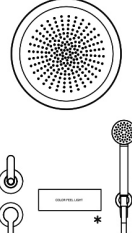
KOMBINATION.1	Art.	Beschreibung	Serienoberfläche
	8136 8027 R685B+M585A R043	Regenkopfbrause Brausearm UP-Brausemischer Brauseset	02 Chrom 13 Schwarz matt 95 Polished Nickel PVD P5 Matt Gun Metal PVD P6 Matt British Gold PVD P9 Matt Copper PVD Q7 Pure Brass PVD Q8 Raw Metal PVD
KOMBINATION.2	Art.	Beschreibung	Serienoberfläche
	K073 8027 R685B+M585A R043	Regenkopfbrause Brausearm UP-Brausemischer Brauseset	02 Chrom 13 Schwarz matt 95 Polished Nickel PVD P5 Matt Gun Metal PVD P6 Matt British Gold PVD P9 Matt Copper PVD
KOMBINATION.3	Art.	Beschreibung	Serienoberfläche
	K072 R685B+M585A R043	Regenkopfbrause UP-Brausemischer Brauseset	02 Chrom 13 Schwarz matt 95 Polished Nickel PVD P5 Matt Gun Metal PVD P6 Matt British Gold PVD P9 Matt Copper PVD
KOMBINATION.4	Art.	Beschreibung	Serienoberfläche
	K062 R685B+M585A R043	Regenkopfbrause UP-Brausemischer Brauseset	02 Chrom 13 Schwarz matt 95 Polished Nickel PVD P5 Matt Gun Metal PVD P6 Matt British Gold PVD P9 Matt Copper PVD
KOMBINATION.5	Art.	Beschreibung	Serienoberfläche
	K061 K101 OPT. R685B+M585A R043	Multifunktionskopfbrause Dream Bedienblende UP-Brausemischer Brauseset	02 Chrom 13 Schwarz matt 95 Polished Nickel PVD P5 Matt Gun Metal PVD P6 Matt British Gold PVD P9 Matt Copper PVD *optional K101 Bedienblende

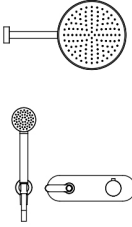
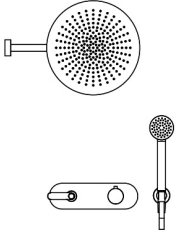
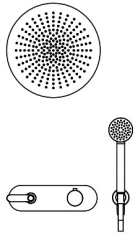
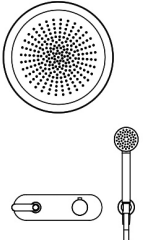
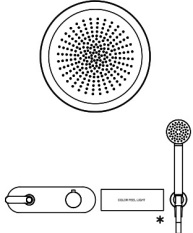
KOMBINATION.1	Art.	Beschreibung	Serienoberfläche
	8136 8027 R872B+D372A R043	Regenkopfbrause Brausearm 3/4" UP-Thermostatbrausemischer Brauseset	02 Chrom 13 Schwarz matt 95 Polished Nickel PVD P5 Matt Gun Metal PVD P6 Matt British Gold PVD P9 Matt Copper PVD Q7 Pure Brass PVD Q8 Raw Metal PVD
KOMBINATION.2	Art.	Beschreibung	Serienoberfläche
	K073 8027 R872B+D372A R043	Regenkopfbrause Brausearm 3/4" UP-Thermostatbrausemischer Brauseset	02 Chrom 13 Schwarz matt 95 Polished Nickel PVD P5 Matt Gun Metal PVD P6 Matt British Gold PVD P9 Matt Copper PVD
KOMBINATION.3	Art.	Beschreibung	Serienoberfläche
	K072 R872B+D372A R043	Regenkopfbrause 3/4" UP-Thermostatbrausemischer Brauseset	02 Chrom 13 Schwarz matt 95 Polished Nickel PVD P5 Matt Gun Metal PVD P6 Matt British Gold PVD P9 Matt Copper PVD
KOMBINATION.4	Art.	Beschreibung	Serienoberfläche
	K062 R872B+D372A R043	Regenkopfbrause 3/4" UP-Thermostatbrausemischer Brauseset	02 Chrom 13 Schwarz matt 95 Polished Nickel PVD P5 Matt Gun Metal PVD P6 Matt British Gold PVD P9 Matt Copper PVD
KOMBINATION.5	Art.	Beschreibung	Serienoberfläche
	K061 K101 OPT. R872B+D372A R043	Multifunktionskopfbrause Dream Bedienblende 3/4" UP-Thermostatbrausemischer Brauseset	02 Chrom 13 Schwarz matt 95 Polished Nickel PVD P5 Matt Gun Metal PVD P6 Matt British Gold PVD P9 Matt Copper PVD *optional K101 Bedienblende

90° KERAMIKOBERTEIL

UP-Wannenmischer

_1/2" Eingänge



R119B+R119A

2 Ausgänge



R117B+R117A

2 Ausgänge

Wannenrandmischer

_1/2" Eingänge



R165

2 Ausgänge



R167

2 Ausgänge

Bodenstand-Wannenmischer

_1/2" Eingänge



R080B+R080A

2 Ausgänge

UP-Wannenmischer

- Achsabstand Auslauf 20 cm
- Griffe
- Drehmsteller **2-Wege**
- Handbrause ICONA
- Wandbogen mit Brausehalter
- Schlauch PVC 150 cm
- 90° Keramikventil
- 1/2" Eingänge

R119B



AP-Teil

Chrom	53 02 R119B
Schwarz matt	53 13 R119B
Polished Nickel PVD	53 95 R119B
Matt Gun Metal PVD	53 P5 R119B
Matt British Gold PVD	53 P6 R119B
Matt Copper PVD	53 P9 R119B
Pure Brass PVD	53 Q7 R119B
Raw Metal PVD	53 Q8 R119B

R119A



UP-Teil

44 00 R119A

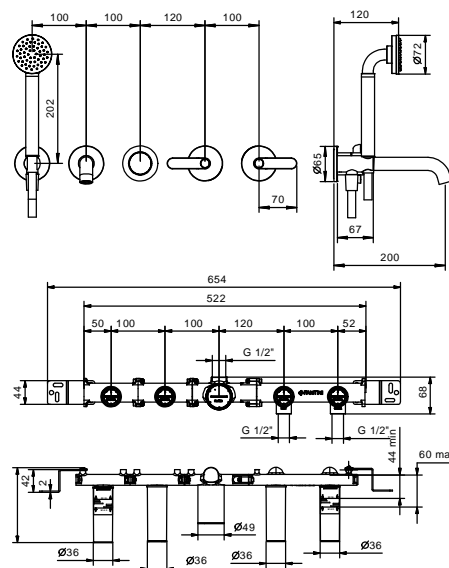

UP-Wannen- und Brausemischer

- Griffe
- ohne Auslauf
- Drehmsteller **2-Wege**
- Handbrause ICONA
- Wandbogen mit Brausehalter
- Schlauch PVC 150 cm
- 90° Keramikventil
- 1/2" Eingänge

R117B



AP-Teil

Chrom	53 02 R117B
Schwarz matt	53 13 R117B
Polished Nickel PVD	53 95 R117B
Matt Gun Metal PVD	53 P5 R117B
Matt British Gold PVD	53 P6 R117B
Matt Copper PVD	53 P9 R117B
Pure Brass PVD	53 Q7 R117B
Raw Metal PVD	53 Q8 R117B

R117A



UP-Teil

44 00 R117A

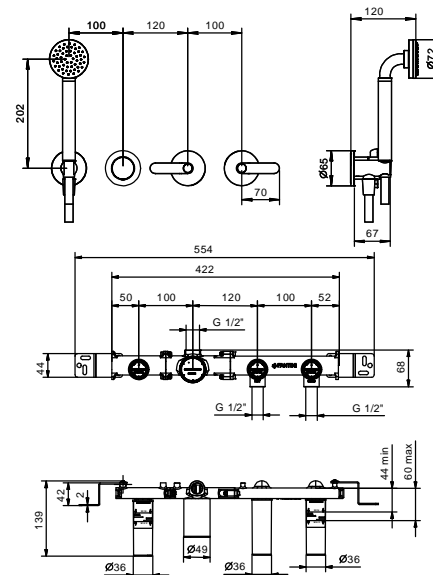

R165

Wannenrandmischer

- Achsabstand Auslauf 16 cm
- Handbrause ICONA
- Griffe
- 5-Loch
- Drehumsteller **2-Wege**
- Schlauch 150 cm
- 90° Keramikventil
- 1/2" Eingänge
- Versorgungsleitung/schläuche

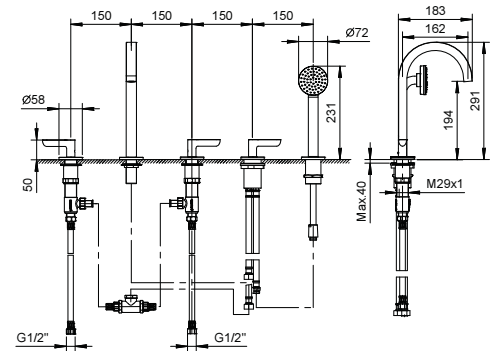

Chrom	53 02 R165
Schwarz matt	53 13 R165
Polished Nickel PVD	53 95 R165
Matt Gun Metal PVD	53 P5 R165
Matt British Gold PVD	53 P6 R165
Matt Copper PVD	53 P9 R165
Pure Brass PVD	53 Q7 R165
Raw Metal PVD	53 Q8 R165

R167

Wannenrandmischer

- Griffe
- ohne Auslauf
- 4-Loch
- Drehumsteller **2-Wege**
- Handbrause ICONA
- Schlauch 150 cm
- 90° Keramikventil
- 1/2" Eingänge
- Versorgungsleitung/schläuche

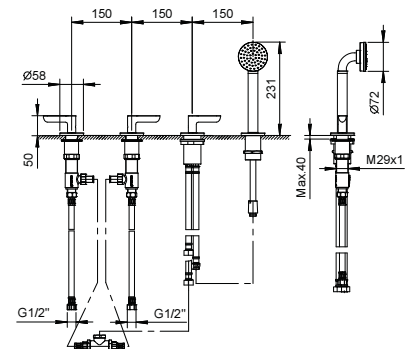

Chrom	53 02 R167
Schwarz matt	53 13 R167
Polished Nickel PVD	53 95 R167
Matt Gun Metal PVD	53 P5 R167
Matt British Gold PVD	53 P6 R167
Matt Copper PVD	53 P9 R167
Pure Brass PVD	53 Q7 R167
Raw Metal PVD	53 Q8 R167

Bodenstand-Wannenmischer

- Achsabstand Auslauf 20,1 cm
- Griff
- Griff (Auf / Zu) mit Mengen- und Temperaturregelung
- Handbrause ICONA
- Handbrausehalter
- Schlauch 150 cm
- 1/2" Eingänge
- auf Fuß

R080B



AP-Teil

Chrom	53 02 R080B
Schwarz matt	53 13 R080B
Polished Nickel PVD	53 95 R080B
Matt Gun Metal PVD	53 P5 R080B
Matt British Gold PVD	53 P6 R080B
Matt Copper PVD	53 P9 R080B
Pure Brass PVD	53 Q7 R080B
Raw Metal PVD	53 Q8 R080B

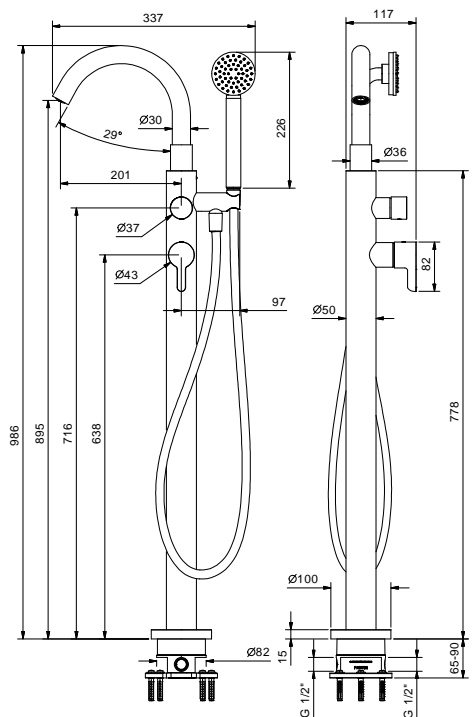

R080A



UP-Teil

44 00 R080A

Z350



Handbrause-Set für Wannenrand

- Handbrause ICONA
- Schlauch 150 cm

Chrom	53 02 Z350
Schwarz matt	53 13 Z350
Polished Nickel PVD	53 95 Z350
Matt Gun Metal PVD	53 P5 Z350
Matt British Gold PVD	53 P6 Z350
Matt Copper PVD	53 P9 Z350
Pure Brass PVD	53 Q7 Z350
Raw Metal PVD	53 Q8 Z350

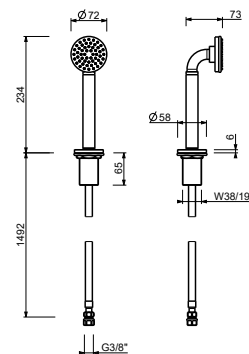

8457

Wannen-Wand-Auslauf

- Achsabstand Auslauf 15 cm
- 1/2" Eingang



Chrom	53 02 8457
Schwarz matt	53 13 8457
Polished Nickel PVD	53 95 8457
Matt Gun Metal PVD	53 P5 8457
Matt British Gold PVD	53 P6 8457
Matt Copper PVD	53 P9 8457
Pure Brass PVD	53 Q7 8457
Raw Metal PVD	53 Q8 8457

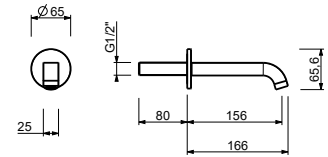

8458

Wannen-Wand-Auslauf

- Achsabstand Auslauf 20 cm
- 1/2" Eingang



Chrom	53 02 8458
Schwarz matt	53 13 8458
Polished Nickel PVD	53 95 8458
Matt Gun Metal PVD	53 P5 8458
Matt British Gold PVD	53 P6 8458
Matt Copper PVD	53 P9 8458
Pure Brass PVD	53 Q7 8458
Raw Metal PVD	53 Q8 8458

