

O-XY

MANUAL TÉCNICO

O-XY

Design Marco Williams Fagioli



95 S604WF

LAVABO	ipág. 378
BIDÉ	ipág. 379
DUCHA	ipág. 381
BAÑO DUCHA	ipág. 393
ACCESORIOS DIVERSOS	ipág. 395

Información técnica

O-XY se suministra de serie **CON MANETA.**



ej. artículo S604WF



ej. artículo P704WF

LAS MANETAS NO SON INTERCAMBIABLES

Los monomandos lavabo se suministran con **limitadores de 5 l/min.**

AGUJEROS PARA INSTALACIÓN EN ENCIMERAS:

- Monomando de lavabo y bidé:

en las cajas se suministra una placa agujereada para colocar en la base del grifo y cubrir el agujero.

Si el diámetro del agujero está comprendido entre MÍN 24 mm - MÁX 25 mm:

NO ES NECESARIO UTILIZAR EL ANILLO BASE.

Si el diámetro del agujero está comprendido entre MÍN 25,1 mm - MÁX 35 mm:

ES NECESARIO UTILIZAR EL ANILLO BASE.

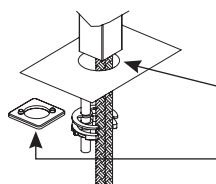

- Batería lavabo 3 elementos.

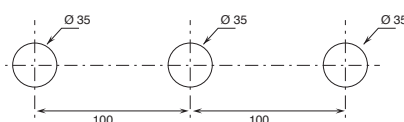

El monomando termostático ducha empotrado 3/4" está disponible:

- art. P831B+D331A - 1 salida

- art. P872B+D372A - 2 salidas

- art. P873B+D373A - 3 salidas

EJEMPLO:

art. P873B+D373A

a) desviador giratorio con cierre - Desde la posición central, girando a la derecha se activa la 1ª salida, al centro el cierre, girando a la izquierda se activa la 2ª salida y luego la 3ª salida en secuencia.

b) control para regular la temperatura.

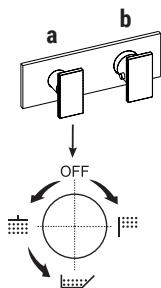

Materiale di base: ACERO AISI 316/316 L

Acabados:

95 Polished Nickel PVD

P5 Matt Gun Metal PVD

93 Acero Cepillado

* Para eventuales recambios, accesorios, artículos varios y prolongaciones, consultar las secciones específicas

CARTUCHO TRADICIONAL

Monomando lavabo

_longitud caño 13,5 cm



S604WF
SIN DESAGÜE



P704WF
SIN DESAGÜE

Monomando lavabo a pared

_longitud caño 17,6 cm

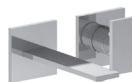

P711B+M011A
SIN DESAGÜE

Monomando bidé

_longitud caño 12,4 cm



S608WF
SIN DESAGÜE



P708WF
SIN DESAGÜE

S604WF

Monomando lavabo

- distancia a chorro 13,5 cm
- maneta
- limitador de caudal 5 l/m a 3 bar
- flexos de alimentación
- SIN DESAGÜE



Polished Nickel PVD 49 95 S604WF
 Matt Gun Metal PVD 49 P5 S604WF

Acero Cepillado 49 93 S604WF

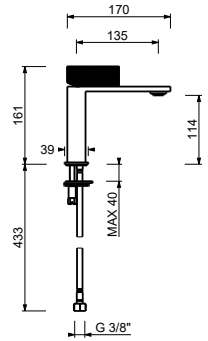

P704WF

Monomando lavabo

- distancia a chorro 13,5 cm
- maneta
- limitador de caudal 5 l/m a 3 bar
- flexos de alimentación
- SIN DESAGÜE



Polished Nickel PVD 49 95 P704WF
 Matt Gun Metal PVD 49 P5 P704WF

Acero Cepillado 49 93 P704WF

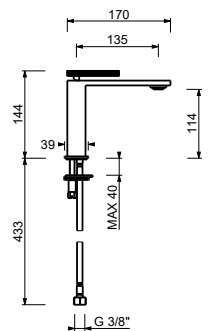

Monomando lavabo a pared

- distancia a chorro 17,6 cm
- maneta
- con placa
- limitador de caudal 5 l/m a 3 bar
- entradas de 1/2"
- aislamiento acústico
- SIN DESAGÜE

P711B

Parte externa

Polished Nickel PVD 49 95 P711B
 Matt Gun Metal PVD 49 P5 P711B

Acero Cepillado 49 93 P711B

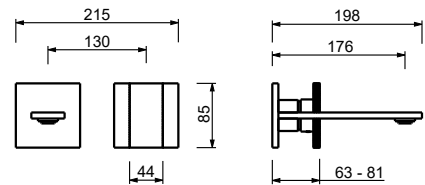
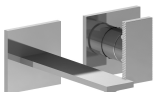

M011A

Parte empotrable

44 00 M011A

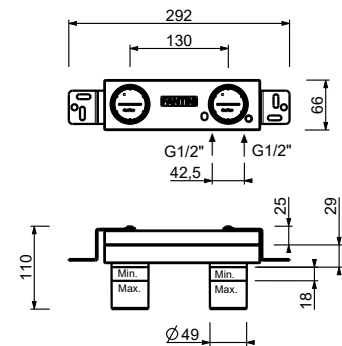

S608WF



Monomando bidé

- distancia a chorro 12,4 cm
- maneta
- limitador de caudal 5 l/m a 3 bar
- aireador orientable
- flexos de alimentación
- SIN DESAGÜE

Polished Nickel PVD 49 95 S608WF
 Matt Gun Metal PVD 49 P5 S608WF

Acero Cepillado 49 93 S608WF

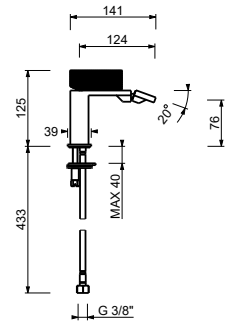

P708WF



Monomando bidé

- distancia a chorro 12,4 cm
- maneta
- limitador de caudal 5 l/m a 3 bar
- aireador orientable
- flexos de alimentación
- SIN DESAGÜE

Polished Nickel PVD 49 95 P708WF
 Matt Gun Metal PVD 49 P5 P708WF

Acero Cepillado 49 93 P708WF

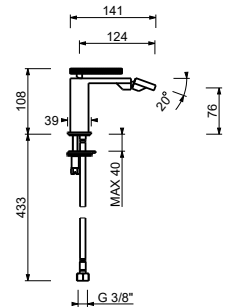

CARTUCHO TRADICIONAL

Monomando ducha empotrado

_entradas de 1/2"



P763B+M063A

1 salida



P785B+M585A

2 salidas



P782B+M685A

2 salidas



P787B+M587A

3 salidas

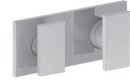

P783B+M687A

3 salidas



P784B+R084A

2 salidas

CARTUCHO TERMOSTÁTICO

Monomando ducha empotrado

_entradas de 3/4"

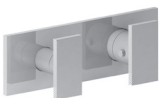

P831B+D331A

1 salida

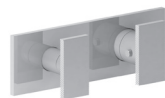

P872B+D372A

2 salidas

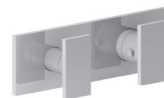

P873B+D373A

3 salidas



P800B+D400A



P891B+D391A

llave de paso

Monomando ducha empotrado

- maneta
- **1 salida** de 1/2"
- entradas de 1/2"
- aislamiento acústico

P763B

Parte externa

Polished Nickel PVD 49 95 P763B
 Matt Gun Metal PVD 49 P5 P763B

Acero Cepillado 49 93 P763B

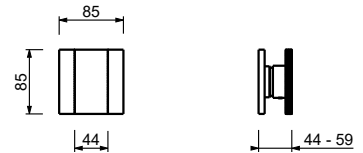

M063A

Parte empotrable

44 00 M063A

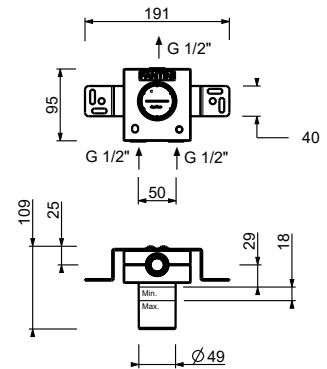

Monomando ducha empotrado

- manetas
- con placa
- desviador giratorio **2 salidas**
- entradas de 1/2"
- aislamiento acústico
- solo para montaje vertical

P785B

Parte externa

Polished Nickel PVD 49 95 P785B
 Matt Gun Metal PVD 49 P5 P785B

Acero Cepillado 49 93 P785B

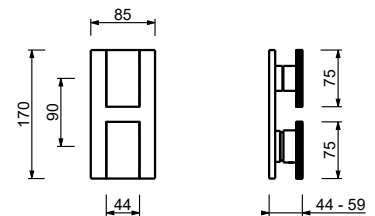

M585A

Parte empotrable

44 00 M585A

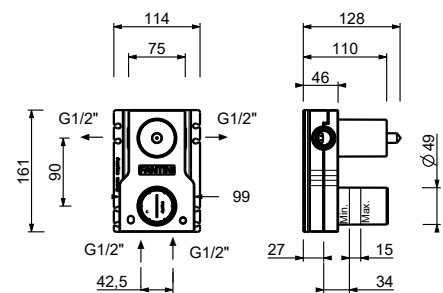

Monomando ducha empotrado

- manetas
- con placa
- desviador giratorio **2 salidas**
- entradas de 1/2"
- aislamiento acústico
- solo para montaje horizontal

P782B

Parte externa

Polished Nickel PVD 49 95 P782B
 Matt Gun Metal PVD 49 P5 P782B

Acero Cepillado 49 93 P782B

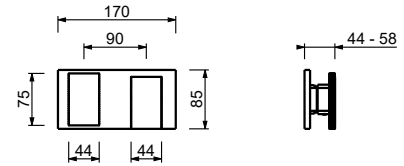
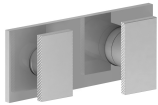

M685A

Parte empotrable

44 00 M685A

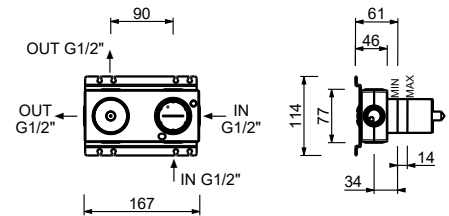
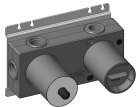

Monomando ducha empotrado

- manetas
- con placa
- desviador giratorio **3 salidas**
- entradas de 1/2"
- aislamiento acústico
- solo para montaje vertical

P787B

Parte externa

Polished Nickel PVD 49 95 P787B
 Matt Gun Metal PVD 49 P5 P787B

Acero Cepillado 49 93 P787B

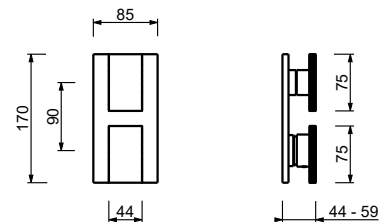
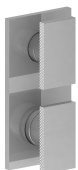

M587A

Parte empotrable

44 00 M587A

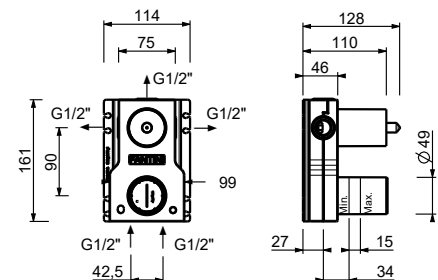

Monomando ducha empotrado

- manetas
- con placa
- desviador giratorio **3 salidas**
- entradas de 1/2"
- aislamiento acústico
- solo para montaje horizontal

P783B

Parte externa

Polished Nickel PVD 49 95 P783B
 Matt Gun Metal PVD 49 P5 P783B

Acero Cepillado 49 93 P783B

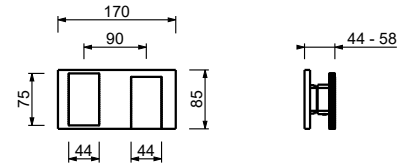
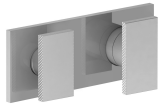

M687A

Parte empotrable

44 00 M687A

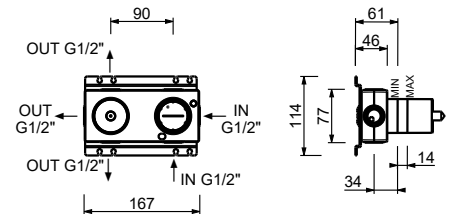
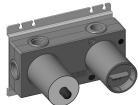

Monomando ducha empotrado

- manetas
- desviador giratorio **2 salidas**
- teleducha FIT
- toma de agua y soporte teleducha
- flexo PVC 150 cm
- entradas de 1/2"

P784B

Parte externa

Polished Nickel PVD 49 95 P784B
 Matt Gun Metal PVD 49 P5 P784B

Acero Cepillado 49 93 P784B

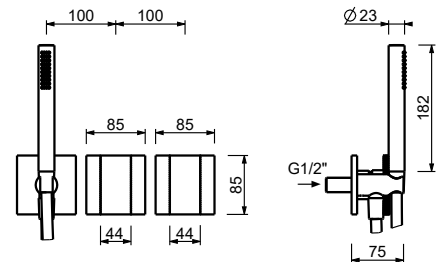

R084A

Parte empotrable

44 00 R084A

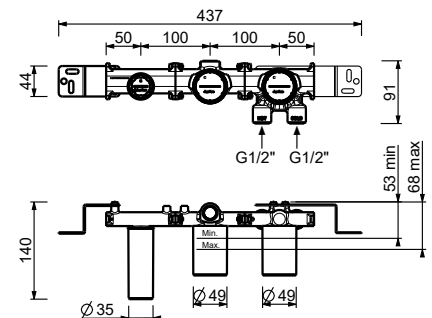

Monomando termostático ducha empotrado 3/4"

- manetas
- **1 salida** de 1/2"
- solo para montaje horizontal
- entradas de 3/4"

P831B

Parte externa

Polished Nickel PVD 49 95 P831B
 Matt Gun Metal PVD 49 P5 P831B

Acero Cepillado 49 93 P831B

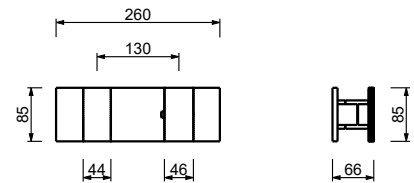
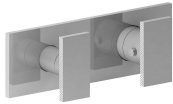

D331A

Parte empotrable

19 00 D331A

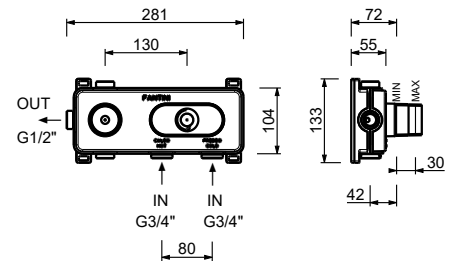

Monomando termostático ducha empotrado 3/4"

- manetas
- desviador giratorio con cierre **2 salidas**
- solo para montaje horizontal
- entradas de 3/4"

P872B

Parte externa

Polished Nickel PVD 49 95 P872B
 Matt Gun Metal PVD 49 P5 P872B

Acero Cepillado 49 93 P872B

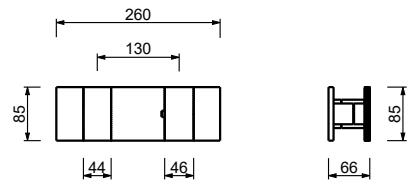
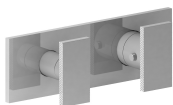

D372A

Parte empotrable

19 00 D372A

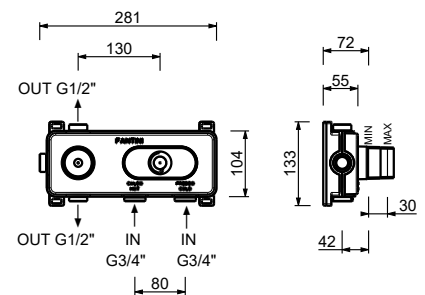

Monomando termostático ducha empotrado 3/4"

- manetas
- desviador giratorio con cierre **3 salidas**
- solo para montaje horizontal
- entradas de 3/4"

P873B

Parte externa

Polished Nickel PVD 49 95 P873B
 Matt Gun Metal PVD 49 P5 P873B

Acero Cepillado 49 93 P873B

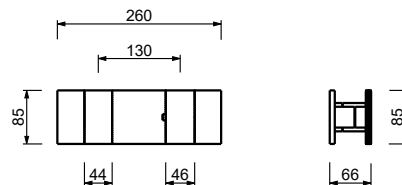
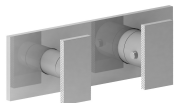

D373A

Parte empotrable

19 00 D373A

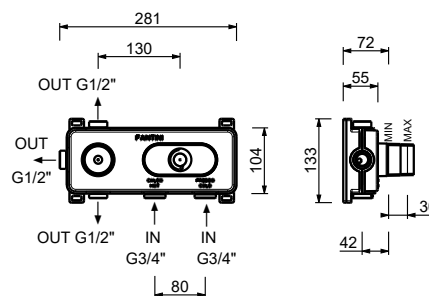

Monomando termostático ducha empotrado 3/4"

- maneta
- entradas de 3/4"
- aislamiento acústico
- sin llave de cierre, **debe pedirse por separado**

NOTA: El mezclador no tiene cierre, debe ser pedido siempre con la llave de paso P891B+D391A

P800B

Parte externa

Polished Nickel PVD 49 95 P800B
 Matt Gun Metal PVD 49 P5 P800B

Acero Cepillado 49 93 P800B

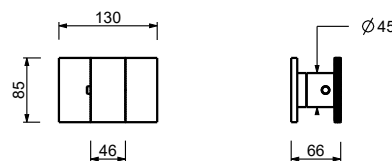

D400A

Parte empotrable

19 00 D400A

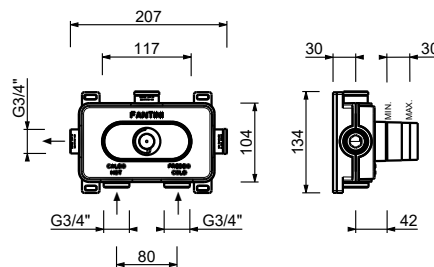

Llave de paso 3/4"

- maneta
- cartucho cerámico 90°
- entradas de 3/4"
- aislamiento acústico

P891B

Parte externa

Polished Nickel PVD 49 95 P891B
 Matt Gun Metal PVD 49 P5 P891B

Acero Cepillado 49 93 P891B

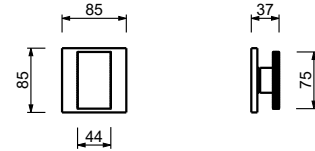

D391A

Parte empotrable

19 00 D391A

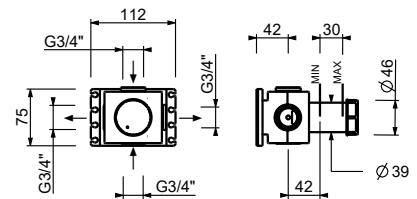

W213

Opcional - Sistema Easy Fix

- placa y conexiones
- para instalación facilitada horizontal o vertical termostáticos
 - para instalación art. D400A / D391A - **1 salida**
 - para instalación art. D400A / D391A - **2 salidas**

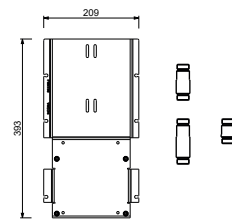

ESEMPI DI COMBINAZIONI - 1 USCITA



ESEMPI DI COMBINAZIONI - 2 USCITE



W214

Opcional - Sistema Easy Fix

placa y conexiones

• para instalación facilitada horizontal o vertical termostáticos

• para instalación tres salidas para instalación art. D400A / D391A - **3 salidas**

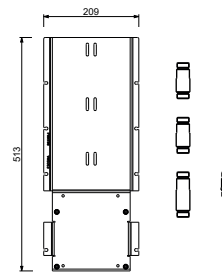
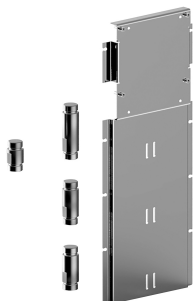

ESEMPI DI COMBINAZIONI - 3 USCITE



91 00 W214

8141

Rociador lluvia

- Material básico: acero
- para instalación a pared
- posibilidad de girar
- sistema anticalcáreo
- entrada de 1/2"



Polished Nickel PVD 49 95 8141
 Matt Gun Metal PVD 49 P5 8141

Acero Cepillado 49 93 8141

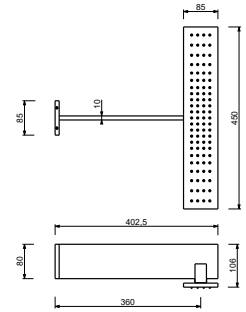

Rociador lluvia

- Material básico: latón
- para instalación a pared
- limitador de caudal 17 l/m a 3 bar
- sistema anticalcáreo
- entrada de 1/2"
- caudal mínimo 10 l/min

**NOTA: Condiciones necesarias para el correcto funcionamiento:
 Caudal mín.: 10 l/min**

8036B

Parte externa

Polished Nickel PVD 86 95 8036B
 Matt Gun Metal PVD 86 P5 8036B

Acero Cepillado 86 93 8036B

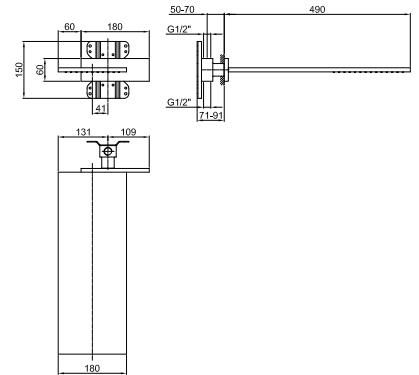

8036A

Parte empotrable

86 00 8036A



K053

Rociador multifunción

- ACQUAFIT
- Funciones agua
- función 1: 125 chorros anticalcareos lluvia enfocada en el centro
- 30x30 cm
- Material básico: acero
- válvula anti-retorno
- limitador de caudal 12 l/m a 3 bar

**NOTA: Condiciones necesarias para el correcto funcionamiento:
Caudal mín.: 9 l/min**

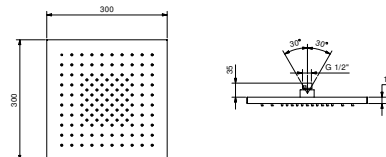

Polished Nickel PVD	79 95 K053
Matt Gun Metal PVD	79 P5 K053
Acero Cepillado	79 93 K053

8038

Brazo ducha

- longitud 30 cm
- embellecedor cuadrado
- para instalación a pared
- entrada de 1/2"



Polished Nickel PVD	86 95 8038
Matt Gun Metal PVD	86 P5 8038
Acero Cepillado	86 93 8038

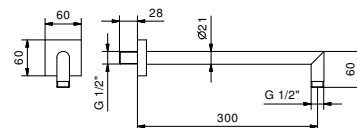

OPCIONAL: Parte empotrable para cartón-yeso

W046	91 00 W046
-------------	------------

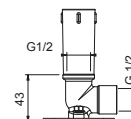

8039

Brazo ducha

- longitud 45 cm
- embellecedor cuadrado
- para instalación a pared
- entrada de 1/2"



Polished Nickel PVD	86 95 8039
Matt Gun Metal PVD	86 P5 8039
Acero Cepillado	86 93 8039

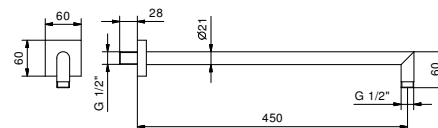

OPCIONAL: Parte empotrable para cartón-yeso

W046	91 00 W046
-------------	------------

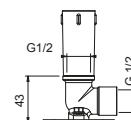

8040

Brazo ducha

- longitud 25 cm
- embellecedor cuadrado
- para instalación a techo
- entrada de 1/2"



Polished Nickel PVD 86 95 8040
 Matt Gun Metal PVD 86 P5 8040

Acero Cepillado 86 93 8040

OPCIONAL: Parte empotrable para cartón-yeso

W046 91 00 W046

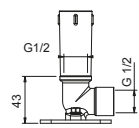
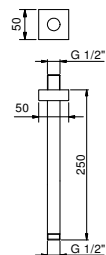

8041

Brazo ducha

- longitud 45 cm
- embellecedor cuadrado
- para instalación a techo
- entrada de 1/2"



Polished Nickel PVD 86 95 8041
 Matt Gun Metal PVD 86 P5 8041

Acero Cepillado 86 93 8041

OPCIONAL: Parte empotrable para cartón-yeso

W046 91 00 W046

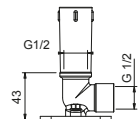
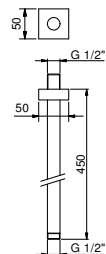

8144

Conjunto de ducha

- teleducha FIT
- toma de agua y soporte teleducha
- embellecedor cuadrado
- flexo PVC 150 cm
- entrada de 1/2"



Polished Nickel PVD 86 95 8144
 Matt Gun Metal PVD 86 P5 8144

Acero Cepillado 86 93 8144

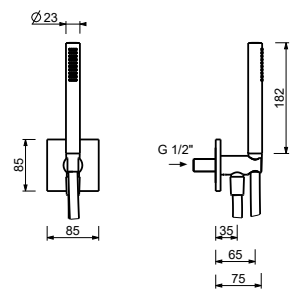

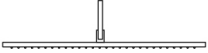
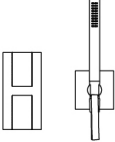
COMPOSICIÓN.1	Art.	Descripción	Acabados
	8141	Rociador lluvia	95 Polished Nickel PVD
	P785B+M585A	Monomando ducha empotrado	P5 Matt Gun Metal PVD
	8144	Conjunto de ducha	93 Acero Cepillado
	8036B+8036A	Rociador lluvia	95 Polished Nickel PVD
	P785B+M585A	Monomando ducha empotrado	P5 Matt Gun Metal PVD
	8144	Conjunto de ducha	93 Acero Cepillado

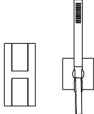
COMPOSICIÓN.2	Art.	Descripción	Acabados
	8036B+8036A	Rociador lluvia	95 Polished Nickel PVD
	P785B+M585A	Monomando ducha empotrado	P5 Matt Gun Metal PVD
	8144	Conjunto de ducha	93 Acero Cepillado
	8036B+8036A	Rociador lluvia	95 Polished Nickel PVD
	P785B+M585A	Monomando ducha empotrado	P5 Matt Gun Metal PVD
	8144	Conjunto de ducha	93 Acero Cepillado

DUCHA : composición cartucho termostático

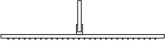
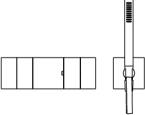
COMPOSICIÓN.1	Art.	Descripción	Acabados
	8141	Rociador lluvia	95 Polished Nickel PVD
	P782B+M685A	Monomando ducha empotrado	P5 Matt Gun Metal PVD
	8144	Conjunto de ducha	93 Acero Cepillado
	8036B+8036A	Rociador lluvia	95 Polished Nickel PVD
	P782B+D372A	Monomando termostático ducha empotrado	P5 Matt Gun Metal PVD
	8144	Conjunto de ducha	93 Acero Cepillado

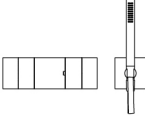
COMPOSICIÓN.2	Art.	Descripción	Acabados
	8036B+8036A	Rociador lluvia	95 Polished Nickel PVD
	P782B+D372A	Monomando termostático ducha empotrado	P5 Matt Gun Metal PVD
	8144	Conjunto de ducha	93 Acero Cepillado
	8036B+8036A	Rociador lluvia	95 Polished Nickel PVD
	P782B+D372A	Monomando termostático ducha empotrado	P5 Matt Gun Metal PVD
	8144	Conjunto de ducha	93 Acero Cepillado

CARTUCHO TRADICIONAL

Monomando baño/ducha empotrado

_entradas de 1/2"



P721B+R021A

2 salidas

Grupo bañera repisa

_entradas de 1/2"



P765

2 salidas



P767

2 salidas

Monomando baño/ducha empotrado

- distancia a chorro 20,8 cm
- maneta
- desviador giratorio **2 salidas**
- teleducha FIT
- toma de agua y soporte teleducha
- flexo PVC 150 cm
- entradas de 1/2"

P721B



Parte externa

Polished Nickel PVD 49 95 P721B
 Matt Gun Metal PVD 49 P5 P721B

Acero Cepillado 49 93 P721B

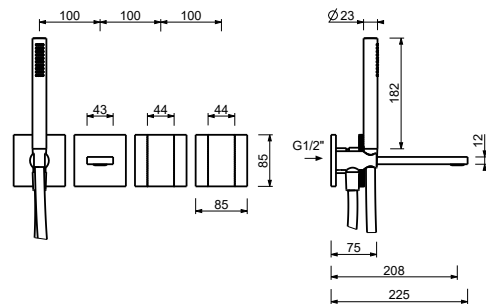

R021A



Parte empotrable

44 00 R021A

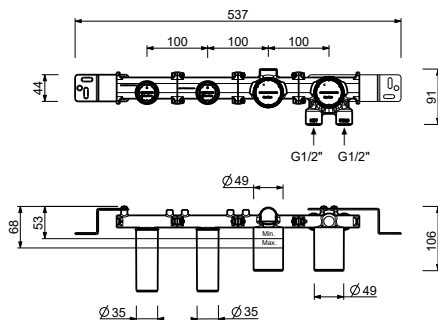

P765

Grupo bañera repisa

- distancia a chorro 15,2 cm
- manetas
- 4 agujeros
- desviador giratorio **2 salidas**
- teleducha FIT
- flexo 150 cm
- entradas de 1/2"
- flexos de alimentación

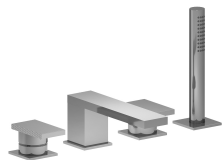

Polished Nickel PVD 49 95 P765
 Matt Gun Metal PVD 49 P5 P765

Acero Cepillado 49 93 P765

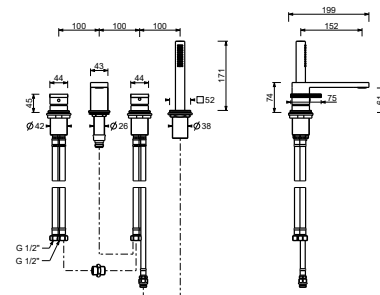

P767

Grupo bañera repisa

- manetas
- sin caño
- 3 agujeros
- desviador giratorio **2 salidas**
- teleducha FIT
- flexo 150 cm
- entradas de 1/2"
- flexos de alimentación



Polished Nickel PVD 49 95 P767
 Matt Gun Metal PVD 49 P5 P767

Acero Cepillado 49 93 P767

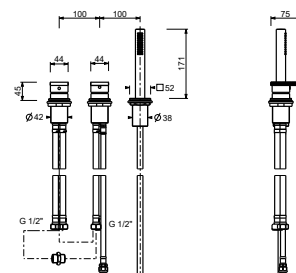

Z351

Juego teleducha para bañera repisa

- teleducha FIT
- flexo 150 cm



Polished Nickel PVD 49 95 Z351
 Matt Gun Metal PVD 49 P5 Z351

Acero Cepillado 49 93 Z351

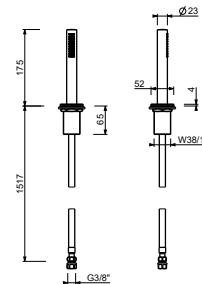

ACCESORIOS DIVERSOS

8434

Desagüe

- 1" 1/4
- tapón a presión
- para lavabo sin rebosadero
- para lavabo con rebosadero
- universal



N.B. listado completo de los acabados en la sección accesorios diversos al final de la tarifa

Polished Nickel PVD 91 95 8434
 Matt Gun Metal PVD 91 P5 8434

Acero Cepillado 91 93 8434

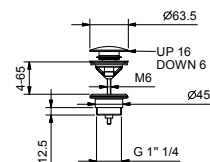

8435

Desagüe

- 1" 1/4
- para lavabo sin rebosadero
- para lavabo con rebosadero
- salida libre
- universal



N.B. listado completo de los acabados en la sección accesorios diversos al final de la tarifa

Polished Nickel PVD 91 95 8435
 Matt Gun Metal PVD 91 P5 8435

Acero Cepillado 91 93 8435

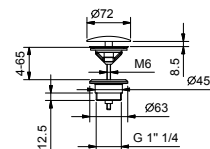

9234

Sifón de botella

- 1" 1/4
- para lavabo



N.B. listado completo de los acabados en la sección accesorios diversos al final de la tarifa

Polished Nickel PVD 91 95 9234
 Matt Gun Metal PVD 91 P5 9234

Acero Cepillado 91 93 9234

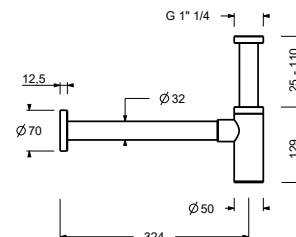

8364

Pareja de llaves de escuadra con filtro

- con cierre
- filtro inspeccionable
- entrada de 1/2"

N.B. listado completo de los acabados en la sección accesorios diversos al final de la tarifa

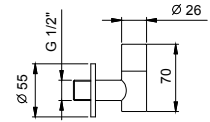

Polished Nickel PVD 91 95 8364
 Matt Gun Metal PVD 91 P5 8364

Acero Cepillado 91 93 8364

8402

Placa y pulsador descarga inodoro

- Material básico: acero
- pulsadores en relieve
- con pulsadores redondos
- compatible con GEBERIT SIGMA8, SIGMA12
- sin fijaciones visibles

N.B. listado completo de los acabados en la sección accesorios diversos al final de la tarifa

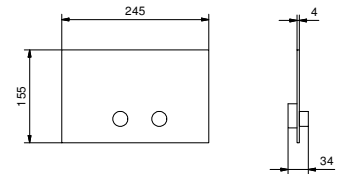

Polished Nickel PVD 91 95 8402
 Matt Gun Metal PVD 91 P5 8402

Acero Cepillado 91 93 8402

8403

Placa y pulsador descarga inodoro

- Material básico: acero
- pulsadores enrasados
- con pulsadores cuadrados
- compatible con GEBERIT SIGMA8, SIGMA12
- sin fijaciones visibles

N.B. listado completo de los acabados en la sección accesorios diversos al final de la tarifa

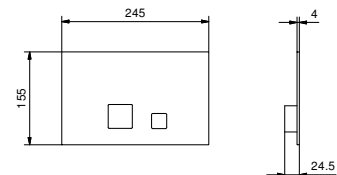

Polished Nickel PVD 91 95 8403
 Matt Gun Metal PVD 91 P5 8403

Acero Cepillado 91 93 8403

W216

Placa y pulsador descarga inodoro

- Material básico: acero
- pulsadores en relieve
- con pulsadores redondos
- compatible con TECEBOX OCTA II
- profundidad mínima: consultar las instrucciones de montaje
- sin fijaciones visibles

N.B. listado completo de los acabados en la sección accesorios diversos al final de la tarifa

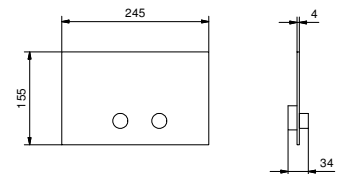

Polished Nickel PVD 91 95 W216
 Matt Gun Metal PVD 91 P5 W216

Acero Cepillado 91 93 W216

8487

Teleducha doble función

- para limpieza WC
- para higiene personal en combinación con grifería ducha
- toma de agua y soporte teleducha
- llave de cierre
- Material básico: latón
- embellecedor cuadrado
- flexo PVC 120 cm
- entrada de 1/2"



N.B : Nickel PVD cepillado para combinar con la serie de acero inoxidable

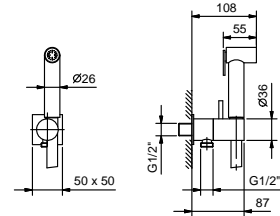

Nickel PVD Cepillado	91 92 8487
Polished Nickel PVD	91 95 8487
Matt Gun Metal PVD	91 P5 8487

W001

Columna desagüe bañera

- con maneta
- CON DESAGÜE

N.B. listado completo de los acabados en la sección accesorios diversos al final de la tarifa



Polished Nickel PVD	91 95 W001
Matt Gun Metal PVD	91 P5 W001

Acero Cepillado 91 93 W001

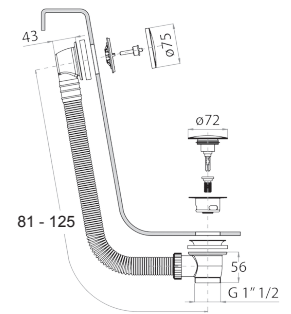

W002

Columna desagüe bañera

- con maneta
- salida de agua en el rebosadero
- CON DESAGÜE

N.B. listado completo de los acabados en la sección accesorios diversos al final de la tarifa



Polished Nickel PVD	91 95 W002
Matt Gun Metal PVD	91 P5 W002

Acero Cepillado 91 93 W002

