

VENEZIA系列

技术说明书

VENEZIA系列

Design Matteo Thun & Antonio Rodriguez



02 N404SW + 02 N448C5 - 02 N448C5

手柄	页.231
面盆龙头	页.239
洗面盆：出水嘴	页.243
妇洗器	页.243
淋浴系列	页.247
淋浴：渐进式阀芯组合	页.260
淋浴：恒温阀芯组合	页.261
浴缸龙头	页.263
浴缸龙头：出水嘴	页.267
杂项物品	页.269

技术信息

VENEZIA系列水龙头组及控水器，均需要单另搭配开关手柄，以便于库存根据不同颜色进行灵活调整搭配。

所有的面盆和净身盆龙头均配有5 l / m限流器。

- 新型渐变阀芯水龙头
逆时针转动手柄90° 可以调整水流温度：冷>温>热

面盆穿孔：

- 面盆龙头组及单孔妇洗器龙头，孔径

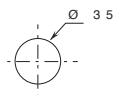

- 三孔式面盆龙头组.

款式. N404S

款式. N405S

款式. N504S

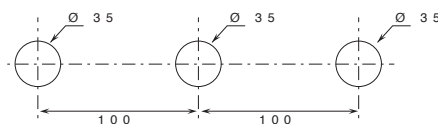

3/4预埋式恒温淋浴龙头适用：

- 款式. G531B+D331A - 单向出水
- 款式. G572B+D372A - 两向出水
- 款式. G573B+D373A - 三向出水

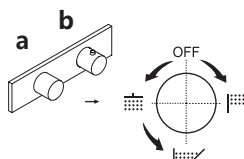

例如:

款式. G573B+D373A

a) 带闭合装置的旋钮式分水器 - 初始为正中心位置，朝右旋转可开启1号出水口，旋转回原位可以关闭水流，朝左旋转可依次开启2号及3号出水口。

b) 温度调节控制柄。

基材：黄铜

漆面:

- 02 铬色
- 95 Polished Nickel PVD
- P5 Matt Gun Metal PVD
- P6 Matt British Gold PVD
- P9 Matt Copper PVD
- 01 超金色

Venezia穆拉诺艺术水晶玻璃手柄

这些手柄的金属底座有不同的漆面可选择。

Venezia系列的穆拉诺玻璃手柄是威尼斯玻璃大师用古老而传统的技术制作而成的。把手内部颜色分布的不均正是艺术玻璃制品所特有的。它们代表了意大利纯手工制作的高品质产品的美丽与真实，使每一件产品都是那么的独一无二且不可复制。

在Venezia水晶手柄中，可能会出现例如小气泡或水晶表面的微小变化之类的小缺陷。这些细微的痕迹是水晶工艺品的固有的特征。他们保证手工工艺，并使得每件作品都是独一无二且不可复制的。

从2016年9月起，穆拉诺玻璃把手将会改变传统做法，采用粘贴工艺，以使整个把手最大化呈现出透明的效果（请参考新编号）。在2016年9月之前购买的产品，需要与新款把手同时预订一组特殊的固定配件（产品编号90 00 8944）。

* 有关备件、配件、杂项型号和延长件，请参阅特定价目表部分



款式号: N404SW
02 - 铬色



N448
(2 pz)



N348
(2 pz)



N546 - DX
N547 - SX



N54613 - DX
N54713 - SX



N448C5
(2 pz)



N448CB
(2 pz)



N448CC
(2 pz)



N448CD
(2 pz)



N748CE
(2 pz)



N748CF
(2 pz)



N748C6
(2 pz)



N748CH
(2 pz)



N748CI
(2 pz)



N748CG
(2 pz)



N646C5 - DX
N647C5 - SX



N646CB - DX
N647CB - SX



款式号: N404SW
01 - 超金色



N448
(2 pz)



N348
(2 pz)



N546 - DX
N547 - SX



N448C5
(2 pz)



N448CB
(2 pz)



N448CC
(2 pz)



N448CD
(2 pz)



N748CE
(2 pz)



N748CF
(2 pz)



N748C6
(2 pz)



N748CH
(2 pz)



N748CI
(2 pz)



N748CG
(2 pz)



N646C5 - DX
N647C5 - SX



N646CB - DX
N647CB - SX



款式号: N404SW
95 - POLISHED NICKEL PVD



N448
(2 pz)

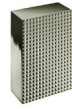

N348
(2 pz)



N546 - DX
N547 - SX



N448C5
(2 pz)



N448CB
(2 pz)



N448CC
(2 pz)



N448CD
(2 pz)



N748CE
(2 pz)



N748CF
(2 pz)



N748C6
(2 pz)



N748CH
(2 pz)



N748CI
(2 pz)



N748CG
(2 pz)



N646C5 - DX
N647C5 - SX



N646CB - DX
N647CB - SX



款式号: N404SW
P5 - MATT GUN METAL PVD



N448
(2 pz)

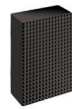

N348
(2 pz)



N546 - DX
N547 - SX



N448C5
(2 pz)



N448CB
(2 pz)



N448CC
(2 pz)



N448CD
(2 pz)



N748CE
(2 pz)



N748CF
(2 pz)



N748C6
(2 pz)



N748CH
(2 pz)



N748CI
(2 pz)



N748CG
(2 pz)



N646C5 - DX
N647C5 - SX



N646CB - DX
N647CB - SX



款式号: N404SW
P6 - MATT BRITISH GOLD PVD



N448
(2 pz)

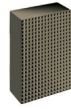

N348
(2 pz)



N546 - DX
N547 - SX



N448C5
(2 pz)



N448CB
(2 pz)



N448CC
(2 pz)



N448CD
(2 pz)



N748CE
(2 pz)



N748CF
(2 pz)



N748C6
(2 pz)



N748CH
(2 pz)



N748CI
(2 pz)



N748CG
(2 pz)



N646C5 - DX N646CB - DX
N647C5 - SX N647CB - SX



款式号: N404SW
P9 - MATT COPPER PVD



N448
(2 pz)

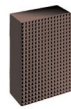

N348
(2 pz)



N546 - DX
N547 - SX



N448C5
(2 pz)



N448CB
(2 pz)



N448CC
(2 pz)



N448CD
(2 pz)



N748CE
(2 pz)



N748CF
(2 pz)



N748C6
(2 pz)



N748CH
(2 pz)



N748CI
(2 pz)



N748CG
(2 pz)



N646C5 - DX N646CB - DX
N647C5 - SX N647CB - SX

1/4转陶瓷阀芯

三孔式面盆龙头组

龙头出水口长度17,5cm



N404SW+N448C5 (2 PZ)

不带排水

N404S+N448C5 (2 PZ)

带下水

三孔式加高款面盆龙头组

龙头出水口长度17,5cm



N405SW+N448C5 (2 PZ)

不带排水

Gruppo lavabo

龙头出水口长度17,5cm



N458SWB+R011A+N448C5 (2 PZ)

墙装远端控制手柄
不带排水

单孔式面盆龙头组

龙头出水口长度17,5cm



N456SWF+N448C5 (2 PZ)

不带排水

N456SF+N448C5 (2 PZ)

带下水

墙装面盆龙头组

龙头出水口长度20cm



N013SB+R010A+N448C5 (2 PZ)

不带排水

单孔式妇洗器龙头组

龙头出水口长度12cm



N462SWF+N448C5 (2 PZ)

不带排水

N462SF+N448C5 (2 PZ)

带下水

三孔式妇洗器龙头组

龙头出水口长度12cm



N409SW

不带排水

N409S

带下水

单孔式妇洗器龙头组

龙头出水口长度12cm



N411SB+R011A+N448C5 (2 PZ)

墙装远端控制手柄
带下水

三孔式面盆龙头组 - VENEZIA IN系列

龙头出水口长度15cm



N504SW+N448C5 (2 PZ)

不带排水

N504S+N448C5 (2 PZ)

带下水

墙装面盆龙头组 - VENEZIA IN系列

龙头出水口长度19,5cm



N113SB+R010A+N448C5 (2 PZ)

不带排水

三孔式妇洗器龙头组 - VENEZIA IN系列

龙头出水口长度13,5cm



N509SW+N448C5 (2 PZ)

不带排水

N509S+N448C5 (2 PZ)

带下水

单孔式妇洗器龙头组 - VENEZIA IN系列

龙头出水口长度13,2cm



N511SB+R011A+N448C5 (2 PZ)

墙装远端控制手柄
带下水

N448

VENEZIA系列手柄

- 基材：黄铜
- 参见产品款式： N404SW - N404S - N504SW - N504S - N405SW - N458SWB - N013SB - N113SB - N456SWF - N456SF - N462SWF - N462SF - N409SW - N409S - N411SB - N509SW - N509S - N511SB - N385SB - N291SB - N465S - N565S - N467S - N580SB - N019SB - N017SB



铬色	29 02 N448
Polished Nickel PVD	29 95 N448
Matt Gun Metal PVD	29 P5 N448
Matt British Gold PVD	29 P6 N448
Matt Copper PVD	29 P9 N448
超金色	29 01 N448

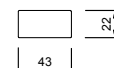
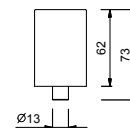

N348

VENEZIA钻石手柄

- 基材：黄铜
- 参见产品款式： N404SW - N404S - N504SW - N504S - N405SW - N458SWB - N013SB - N113SB - N456SWF - N456SF - N462SWF - N462SF - N409SW - N409S - N411SB - N509SW - N509S - N511SB - N385SB - N291SB - N465S - N565S - N467S - N580SB - N019SB - N017SB

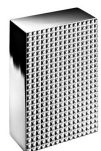

铬色	29 02 N348
Polished Nickel PVD	29 95 N348
Matt Gun Metal PVD	29 P5 N348
Matt British Gold PVD	29 P6 N348
Matt Copper PVD	29 P9 N348
超金色	29 01 N348

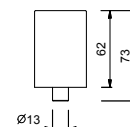

N448C5

VENEZIA系列手柄 (穆拉诺玻璃型) - 黑色

- 黄铜手柄支架
- 参见产品款式： N404SW - N404S - N504SW - N504S - N405SW - N458SWB - N013SB - N113SB - N456SWF - N456SF - N462SWF - N462SF - N409SW - N409S - N411SB - N509SW - N509S - N511SB - N385SB - N291SB - N465S - N565S - N467S - N580SB - N019SB - N017SB



铬色	29 02 N448C5
Polished Nickel PVD	29 95 N448C5
Matt Gun Metal PVD	29 P5 N448C5
Matt British Gold PVD	29 P6 N448C5
Matt Copper PVD	29 P9 N448C5
超金色	29 01 N448C5

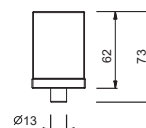

N448CB

VENEZIA系列手柄 (穆拉诺玻璃型) - 白色

- 黄铜手柄支架
- 参见产品款式： N404SW - N404S - N504SW - N504S - N405SW - N458SWB - N013SB - N113SB - N456SWF - N456SF - N462SWF - N462SF - N409SW - N409S - N411SB - N509SW - N509S - N511SB - N385SB - N291SB - N465S - N565S - N467S - N580SB - N019SB - N017SB



铬色	29 02 N448CB
Polished Nickel PVD	29 95 N448CB
Matt Gun Metal PVD	29 P5 N448CB
Matt British Gold PVD	29 P6 N448CB
Matt Copper PVD	29 P9 N448CB
超金色	29 01 N448CB

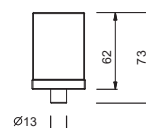

N448CC

VENEZIA系列手柄 (穆拉诺玻璃型) - 红色

- 黄铜手柄支架
- 参见产品款式： N404SW - N404S - N504SW - N504S - N405SW - N458SWB - N013SB - N113SB - N456SWF - N456SF - N462SWF - N462SF - N409SW - N409S - N411SB - N509SW - N509S - N511SB - N385SB - N291SB - N465S - N565S - N467S - N580SB - N019SB - N017SB

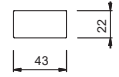
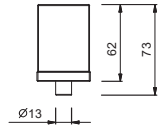

铬色	29 02 N448CC
Polished Nickel PVD	29 95 N448CC
Matt Gun Metal PVD	29 P5 N448CC
Matt British Gold PVD	29 P6 N448CC
Matt Copper PVD	29 P9 N448CC
超金色	29 01 N448CC

N448CD

VENEZIA系列手柄 (穆拉诺玻璃型) - 蓝色

- 黄铜手柄支架
- 参见产品款式： N404SW - N404S - N504SW - N504S - N405SW - N458SWB - N013SB - N113SB - N456SWF - N456SF - N462SWF - N462SF - N409SW - N409S - N411SB - N509SW - N509S - N511SB - N385SB - N291SB - N465S - N565S - N467S - N580SB - N019SB - N017SB

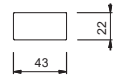
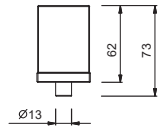

铬色	29 02 N448CD
Polished Nickel PVD	29 95 N448CD
Matt Gun Metal PVD	29 P5 N448CD
Matt British Gold PVD	29 P6 N448CD
Matt Copper PVD	29 P9 N448CD
超金色	29 01 N448CD

N748C6

Venezia水晶把手-透明白色

- 黄铜手柄支架
- 参见产品款式：N404SW - N404S - N504SW - N504S - N405SW - N409SW - N409S - N509SW - N509S - N465S - N565S - N467S



铬色	29 02 N748C6
Polished Nickel PVD	29 95 N748C6
Matt Gun Metal PVD	29 P5 N748C6
Matt British Gold PVD	29 P6 N748C6
Matt Copper PVD	29 P9 N748C6
超金色	29 01 N748C6

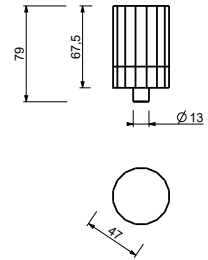

N748CH

Venezia水晶把手-哑光白色

- 黄铜手柄支架
- 参见产品款式：N404SW - N404S - N504SW - N504S - N405SW - N409SW - N409S - N509SW - N509S - N465S - N565S - N467S



铬色	29 02 N748CH
Polished Nickel PVD	29 95 N748CH
Matt Gun Metal PVD	29 P5 N748CH
Matt British Gold PVD	29 P6 N748CH
Matt Copper PVD	29 P9 N748CH
超金色	29 01 N748CH

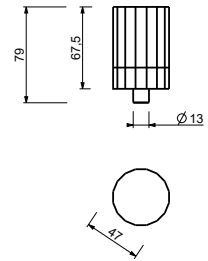

N748CE

Venezia水晶把手-透明浅蓝色

- 黄铜手柄支架
- 参见产品款式：N404SW - N404S - N504SW - N504S - N405SW - N409SW - N409S - N509SW - N509S - N465S - N565S - N467S



铬色	29 02 N748CE
Polished Nickel PVD	29 95 N748CE
Matt Gun Metal PVD	29 P5 N748CE
Matt British Gold PVD	29 P6 N748CE
Matt Copper PVD	29 P9 N748CE
超金色	29 01 N748CE

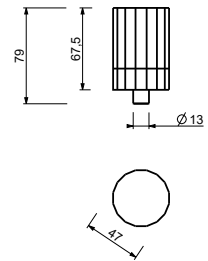

N748CF

Venezia水晶把手-哑光浅蓝色

- 黄铜手柄支架
- 参见产品款式：N404SW - N404S - N504SW - N504S - N405SW - N409SW - N409S - N509SW - N509S - N465S - N565S - N467S



铬色	29 02 N748CF
Polished Nickel PVD	29 95 N748CF
Matt Gun Metal PVD	29 P5 N748CF
Matt British Gold PVD	29 P6 N748CF
Matt Copper PVD	29 P9 N748CF
超金色	29 01 N748CF

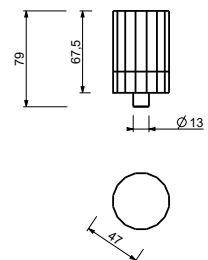

N748CI

Venezia水晶把手-透明琥珀色

- 黄铜手柄支架
- 参见产品款式：N404SW - N404S - N504SW - N504S - N405SW - N409SW - N409S - N509SW - N509S - N465S - N565S - N467S



铬色	29 02 N748CI
Polished Nickel PVD	29 95 N748CI
Matt Gun Metal PVD	29 P5 N748CI
Matt British Gold PVD	29 P6 N748CI
Matt Copper PVD	29 P9 N748CI
超金色	29 01 N748CI

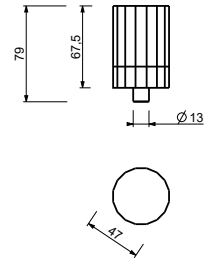

N748CG

Venezia水晶把手-哑光琥珀色

- 黄铜手柄支架
- 参见产品款式：N404SW - N404S - N504SW - N504S - N405SW - N409SW - N409S - N509SW - N509S - N465S - N565S - N467S



铬色	29 02 N748CG
Polished Nickel PVD	29 95 N748CG
Matt Gun Metal PVD	29 P5 N748CG
Matt British Gold PVD	29 P6 N748CG
Matt Copper PVD	29 P9 N748CG
超金色	29 01 N748CG

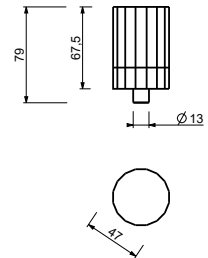

N746C6

Venezia水晶把手-透明白色

- 黄铜手柄支架
- 参见产品款式：N013SB - N113SB - N458SWB+R011A - N411SB+R011A - N511SB+R011A - N291SB - N019SB - N017SB



铬色	29 02 N746C6
Polished Nickel PVD	29 95 N746C6
Matt Gun Metal PVD	29 P5 N746C6
Matt British Gold PVD	29 P6 N746C6
Matt Copper PVD	29 P9 N746C6
超金色	29 01 N746C6

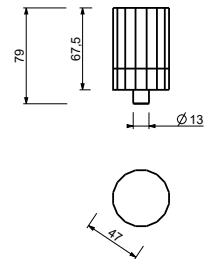

N746CH

Venezia水晶把手-哑光白色

- 黄铜手柄支架
- 参见产品款式：N013SB - N113SB - N458SWB+R011A - N411SB+R011A - N511SB+R011A - N291SB - N019SB - N017SB



铬色	29 02 N746CH
Polished Nickel PVD	29 95 N746CH
Matt Gun Metal PVD	29 P5 N746CH
Matt British Gold PVD	29 P6 N746CH
Matt Copper PVD	29 P9 N746CH
超金色	29 01 N746CH

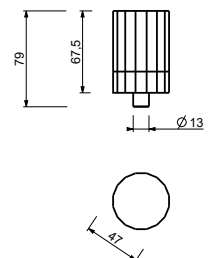

N746CE

Venezia水晶把手-透明浅蓝色

- 黄铜手柄支架
- 参见产品款式：N013SB - N113SB - N458SWB+R011A - N411SB+R011A - N511SB+R011A - N291SB - N019SB - N017SB



铬色	29 02 N746CE
Polished Nickel PVD	29 95 N746CE
Matt Gun Metal PVD	29 P5 N746CE
Matt British Gold PVD	29 P6 N746CE
Matt Copper PVD	29 P9 N746CE
超金色	29 01 N746CE

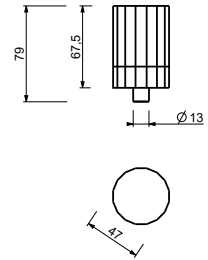

N746CF

Venezia水晶把手-哑光浅蓝色

- 黄铜手柄支架
- 参见产品款式：N013SB - N113SB - N458SWB+R011A - N411SB+R011A - N511SB+R011A - N291SB - N019SB - N017SB



铬色	29 02 N746CF
Polished Nickel PVD	29 95 N746CF
Matt Gun Metal PVD	29 P5 N746CF
Matt British Gold PVD	29 P6 N746CF
Matt Copper PVD	29 P9 N746CF
超金色	29 01 N746CF

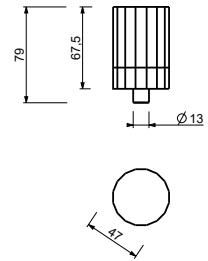

N746CI

Venezia水晶把手-透明琥珀色

- 黄铜手柄支架
- 参见产品款式：N013SB - N113SB - N458SWB+R011A - N411SB+R011A - N511SB+R011A - N291SB - N019SB - N017SB



铬色	29 02 N746CI
Polished Nickel PVD	29 95 N746CI
Matt Gun Metal PVD	29 P5 N746CI
Matt British Gold PVD	29 P6 N746CI
Matt Copper PVD	29 P9 N746CI
超金色	29 01 N746CI

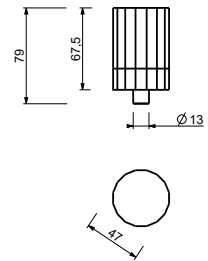

N746CG

Venezia水晶把手-哑光琥珀色

- 黄铜手柄支架
- 参见产品款式：N013SB - N113SB - N458SWB+R011A - N411SB+R011A - N511SB+R011A - N291SB - N019SB - N017SB



铬色	29 02 N746CG
Polished Nickel PVD	29 95 N746CG
Matt Gun Metal PVD	29 P5 N746CG
Matt British Gold PVD	29 P6 N746CG
Matt Copper PVD	29 P9 N746CG
超金色	29 01 N746CG

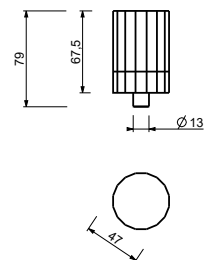

N646C5

VENEZIA 水晶把手 "C" (冷水), 右手 - 黑色

- 黄铜手柄支架
- 参见产品款式: N404SW - N404S - N504SW - N504S - N405SW - N458SWB - N013SB - N113SB - N409SW - N409S - N411SB - N509SW - N509S - N511SB - N465S - N565S - N467S - N019SB - N017SB



铬色	29 02 N646C5
Polished Nickel PVD	29 95 N646C5
Matt Gun Metal PVD	29 P5 N646C5
Matt British Gold PVD	29 P6 N646C5
Matt Copper PVD	29 P9 N646C5
超金色	29 01 N646C5

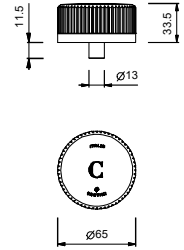

N646CB

VENEZIA 水晶把手 "C" (冷水), 右手 - 白色

- 黄铜手柄支架
- 参见产品款式: N404SW - N404S - N504SW - N504S - N405SW - N458SWB - N013SB - N113SB - N409SW - N409S - N411SB - N509SW - N509S - N511SB - N465S - N565S - N467S - N019SB - N017SB



铬色	29 02 N646CB
Polished Nickel PVD	29 95 N646CB
Matt Gun Metal PVD	29 P5 N646CB
Matt British Gold PVD	29 P6 N646CB
Matt Copper PVD	29 P9 N646CB
超金色	29 01 N646CB

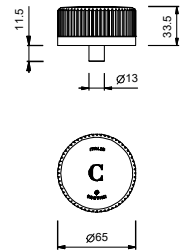

N647C5

VENEZIA 水晶把手 "H" (热水), 左手 - 黑色

- 黄铜手柄支架
- 参见产品款式: N404SW - N404S - N504SW - N504S - N405SW - N458SWB - N013SB - N113SB - N409SW - N409S - N411SB - N509SW - N509S - N511SB - N465S - N565S - N467S - N019SB - N017SB



铬色	29 02 N647C5
Polished Nickel PVD	29 95 N647C5
Matt Gun Metal PVD	29 P5 N647C5
Matt British Gold PVD	29 P6 N647C5
Matt Copper PVD	29 P9 N647C5
超金色	29 01 N647C5

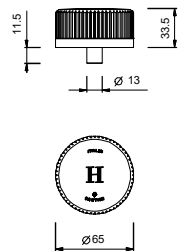

N647CB

VENEZIA 水晶把手 "H" (热水), 左手 - 白色

- 黄铜手柄支架
- 参见产品款式: N404SW - N404S - N504SW - N504S - N405SW - N458SWB - N013SB - N113SB - N409SW - N409S - N411SB - N509SW - N509S - N511SB - N465S - N565S - N467S - N019SB - N017SB



铬色	29 02 N647CB
Polished Nickel PVD	29 95 N647CB
Matt Gun Metal PVD	29 P5 N647CB
Matt British Gold PVD	29 P6 N647CB
Matt Copper PVD	29 P9 N647CB
超金色	29 01 N647CB

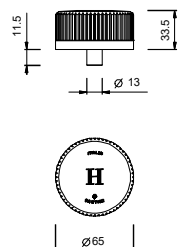

N648C5

VENEZIA 原色水晶把手 - 黑色

- 黄铜手柄支架
- 参见产品款式：N385SB - N291SB



铬色	29 02 N648C5
Polished Nickel PVD	29 95 N648C5
Matt Gun Metal PVD	29 P5 N648C5
Matt British Gold PVD	29 P6 N648C5
Matt Copper PVD	29 P9 N648C5
超金色	29 01 N648C5

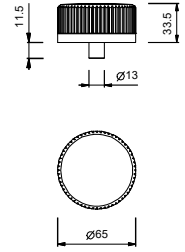

N648CB

VENEZIA 原色水晶把手 - 白色

- 黄铜手柄支架
- 参见产品款式：N385SB - N291SB



铬色	29 02 N648CB
Polished Nickel PVD	29 95 N648CB
Matt Gun Metal PVD	29 P5 N648CB
Matt British Gold PVD	29 P6 N648CB
Matt Copper PVD	29 P9 N648CB
超金色	29 01 N648CB

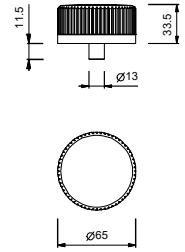

N54613

VENEZIA提拉式右边把手

- 基材：黄铜
- 带黑色手柄
- 参见产品款式：N404SW - N404S - N504SW - N504S - N405SW - N458SWB - N013SB - N113SB - N409SW - N409S - N411SB - N509SW - N509S - Errore!

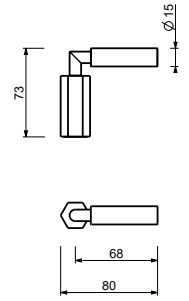

铬色-哑光黑

29 02 N54613

N54713

VENEZIA提拉式左边把手

- 基材：黄铜
- 带黑色手柄
- 参见产品款式：N404SW - N404S - N504SW - N504S - N405SW - N458SWB - N013SB - N113SB - N409SW - N409S - N411SB - N509SW - N509S - N511SB - N465S - N565S - N467S - N580SB

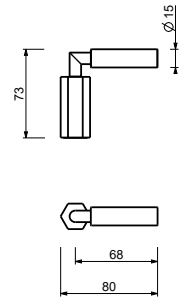

铬色-哑光黑

29 02 N54713

N546

VENEZIA提拉式右边把手

- 基材：黄铜
- 参见产品款式：N404SW - N404S - N504SW - N504S - N405SW - N458SWB - N013SB - N113SB - N409SW - N409S - N411SB - N509SW - N509S - Errore!

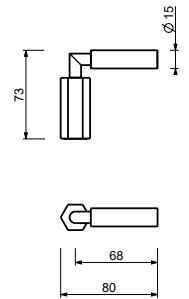

铬色	29 02 N546
Polished Nickel PVD	29 95 N546
Matt Gun Metal PVD	29 P5 N546
Matt British Gold PVD	29 P6 N546
Matt Copper PVD	29 P9 N546
超金色	29 01 N546

N547

VENEZIA提拉式左边把手

- 基材：黄铜
- 参见产品款式：N404SW - N404S - N504SW - N504S - N405SW - N458SWB - N013SB - N113SB - N409SW - N409S - N411SB - N509SW - N509S - N511SB - N465S - N565S - N467S - N580SB

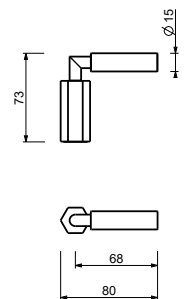

铬色	29 02 N547
Polished Nickel PVD	29 95 N547
Matt Gun Metal PVD	29 P5 N547
Matt British Gold PVD	29 P6 N547
Matt Copper PVD	29 P9 N547
超金色	29 01 N547

N404SW lead free



三孔式面盆龙头

- 龙头出水口长度17.5cm
- 不带开关把手
- 流速限制器 5升/分钟 3 bar
- 90°陶瓷阀芯
- 供水软管
- 不带排水塞

注意：水龙头把手需要单独预定，请参看“开关把手”部分

铬色	29 02 N404SW
Polished Nickel PVD	29 95 N404SW
Matt Gun Metal PVD	29 P5 N404SW
Matt British Gold PVD	29 P6 N404SW
Matt Copper PVD	29 P9 N404SW
超金色	29 01 N404SW

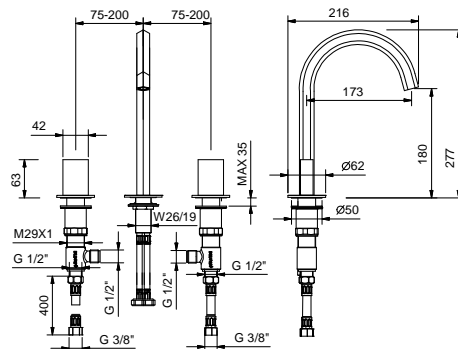

N404S lead free



三孔式面盆龙头

- 龙头出水口长度17.5cm
- 不带开关把手
- 流速限制器 5升/分钟 3 bar
- 90°陶瓷阀芯
- 供水软管
- 按压式去水塞

注意：水龙头把手需要单独预定，请参看“开关把手”部分

铬色	29 02 N404S
Polished Nickel PVD	29 95 N404S
Matt Gun Metal PVD	29 P5 N404S
Matt British Gold PVD	29 P6 N404S
Matt Copper PVD	29 P9 N404S
超金色	29 01 N404S

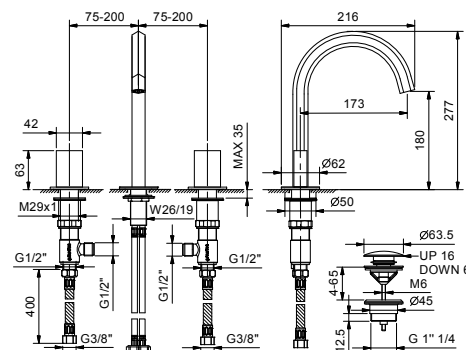

N504SW lead free



三孔式面盆龙头组 - VENEZIA IN

- 龙头出水口长度15cm
- 不带开关把手
- 流速限制器 5升/分钟 3 bar
- 90°陶瓷阀芯
- 供水软管
- 不带排水塞

注意：水龙头把手需要单独预定，请参看“开关把手”部分

铬色	29 02 N504SW
Polished Nickel PVD	29 95 N504SW
Matt Gun Metal PVD	29 P5 N504SW
Matt British Gold PVD	29 P6 N504SW
Matt Copper PVD	29 P9 N504SW
超金色	29 01 N504SW

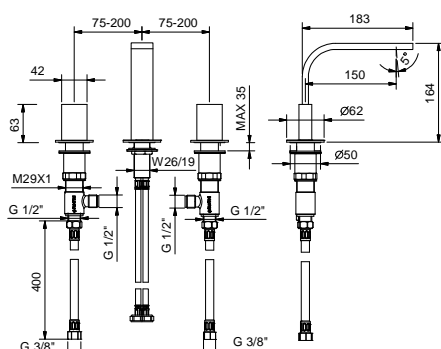

N504S lead free



三孔式面盆龙头组 - VENEZIA IN

- 龙头出水口长度15cm
- 不带开关把手
- 流速限制器 5升/分钟 3 bar
- 90°陶瓷阀芯
- 供水软管
- 按压式去水塞

注意：水龙头把手需要单独预定，请参看“开关把手”部分

铬色	29 02 N504S
Polished Nickel PVD	29 95 N504S
Matt Gun Metal PVD	29 P5 N504S
Matt British Gold PVD	29 P6 N504S
Matt Copper PVD	29 P9 N504S
超金色	29 01 N504S

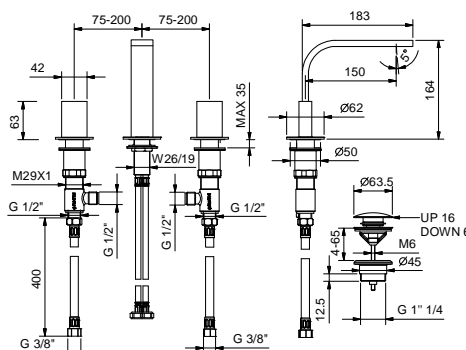

N405SW lead-free



三孔式加高面盆龙头组

- 龙头出水口长度17.5cm
- 不带开关把手
- 流速限制器 5升/分钟 3 bar
- 90°陶瓷阀芯
- 供水软管
- 不带排水塞

注意：水龙头把手需要单独预定，请参看“开关把手”部分

铬色	29 02 N405SW
Polished Nickel PVD	29 95 N405SW
Matt Gun Metal PVD	29 P5 N405SW
Matt British Gold PVD	29 P6 N405SW
Matt Copper PVD	29 P9 N405SW
超金色	29 01 N405SW

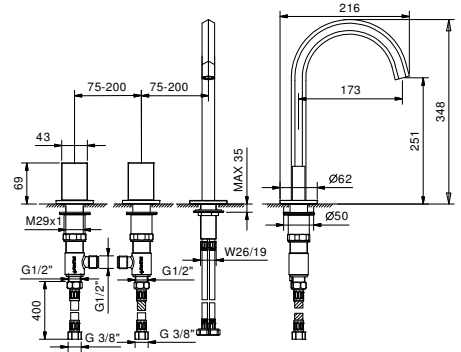

单孔式面盆龙头组

- 龙头出水口长度17.5cm
- 不带开关把手
- 墙装控制开关
- 流速限制器 5升/分钟 3 bar
- 90°陶瓷阀芯
- 1/2" 寸入水管
- 供水软管
- 不带排水塞

注意：水龙头把手需要单独预定，请参看“开关把手”部分

N458SWB



外部组件

铬色	29 02 N458SWB
Polished Nickel PVD	29 95 N458SWB
Matt Gun Metal PVD	29 P5 N458SWB
Matt British Gold PVD	29 P6 N458SWB
Matt Copper PVD	29 P9 N458SWB
超金色	29 01 N458SWB

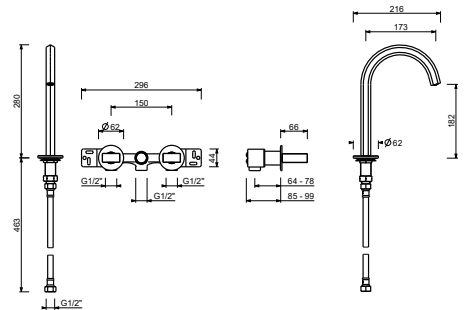

R011A



墙内预埋组件

44 00 R011A

N456SWF



单孔式面盆龙头组

- 龙头出水口长度17.5cm
- 不带开关把手
- 流速限制器 5升/分钟 3 bar
- 90°陶瓷阀芯
- 供水软管
- 不带排水塞

注意：水龙头把手需要单独预定，请参看“开关把手”部分

铬色	29 02 N456SWF
Polished Nickel PVD	29 95 N456SWF
Matt Gun Metal PVD	29 P5 N456SWF
Matt British Gold PVD	29 P6 N456SWF
Matt Copper PVD	29 P9 N456SWF
超金色	29 01 N456SWF

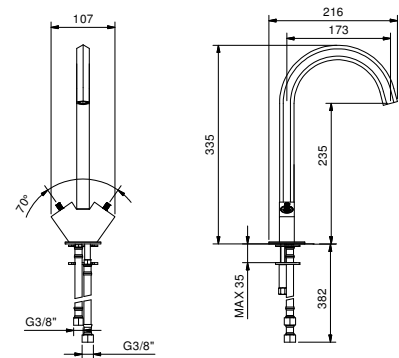

N456SF

单孔式面盆龙头组

- 龙头出水口长度17.5cm
- 不带开关把手
- 流速限制器 5升/分钟 3 bar
- 90°陶瓷阀芯
- 供水软管
- 按压式去水塞

注意：水龙头把手需要单独预定，请参看“开关把手”部分

铬色	29 02 N456SF
Polished Nickel PVD	29 95 N456SF
Matt Gun Metal PVD	29 P5 N456SF
Matt British Gold PVD	29 P6 N456SF
Matt Copper PVD	29 P9 N456SF
超金色	29 01 N456SF

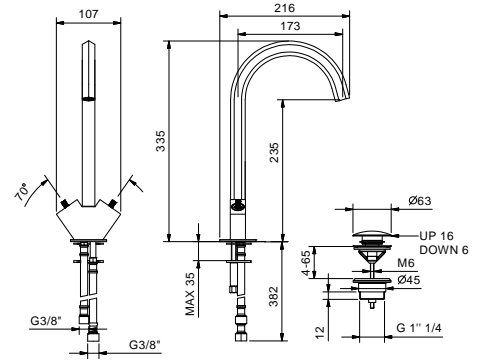

lead free

墙出面盆龙头

- 龙头出水口长度20cm
- 不带开关把手
- 流速限制器 5升/分钟 3 bar
- 90°陶瓷阀芯
- 1/2" 寸入水管
- 不带排水塞

注意：水龙头把手需要单独预定，请参看“开关把手”部分

外部组件

铬色	29 02 N013SB
Polished Nickel PVD	29 95 N013SB
Matt Gun Metal PVD	29 P5 N013SB
Matt British Gold PVD	29 P6 N013SB
Matt Copper PVD	29 P9 N013SB
超金色	29 01 N013SB

N013SB

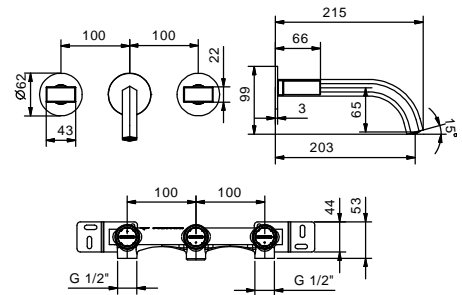

R010A

墙内预埋组件

44 00 R010A

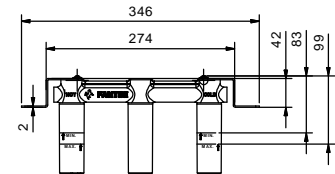

lead \varnothing free

墙装面盆龙头组 - VENEZIA IN

- 龙头出水口长度19.5cm
- 不带开关把手
- 流速限制器 5升/分钟 3 bar
- 90°陶瓷阀芯
- 1/2" 寸入水管
- 不带排水塞

注意：水龙头把手需要单独预定，请参看“开关把手”部分

N113SB



外部组件

铬色	29 02 N113SB
Polished Nickel PVD	29 95 N113SB
Matt Gun Metal PVD	29 P5 N113SB
Matt British Gold PVD	29 P6 N113SB
Matt Copper PVD	29 P9 N113SB
超金色	29 01 N113SB

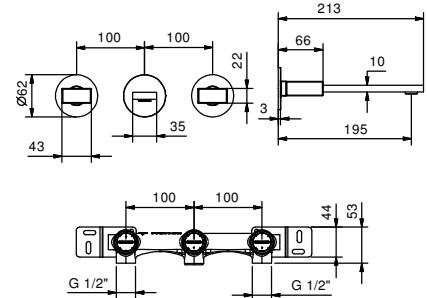

R010A

墙内预埋组件

44 00 R010A

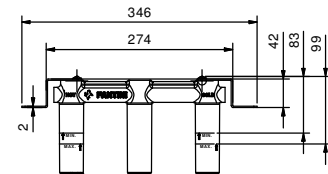

洗面盆：出水嘴

8320

lead \varnothing free

墙装面盆出水口

- 龙头出水口长度20cm
- 流速限制器 5升/分钟 3 bar
- 1/2" 寸入水管



铬色	29 02 8320
Polished Nickel PVD	29 95 8320
Matt Gun Metal PVD	29 P5 8320
Matt British Gold PVD	29 P6 8320
Matt Copper PVD	29 P9 8320
超金色	29 01 8320

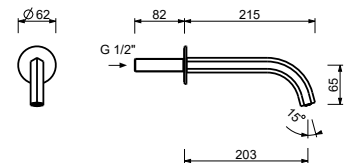

N409SW

三孔式妇洗器

- 龙头出水口长度12cm
- 不带开关把手
- 流速限制器 5升/分钟 3 bar
- 90°陶瓷阀芯
- 铰接式起泡器
- 供水软管
- 不带排水塞



注意：水龙头把手需要单独预定，请参看“开关把手”部分

铬色	29 02 N409SW
Polished Nickel PVD	29 95 N409SW
Matt Gun Metal PVD	29 P5 N409SW
Matt British Gold PVD	29 P6 N409SW
Matt Copper PVD	29 P9 N409SW
超金色	29 01 N409SW

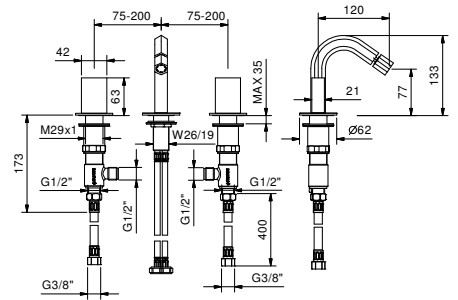

N409S

三孔式妇洗器

- 龙头出水口长度12cm
- 不带开关把手
- 流速限制器 5升/分钟 3 bar
- 90°陶瓷阀芯
- 铰接式起泡器
- 供水软管
- 按压式去水塞



注意：水龙头把手需要单独预定，请参看“开关把手”部分

铬色	29 02 N409S
Polished Nickel PVD	29 95 N409S
Matt Gun Metal PVD	29 P5 N409S
Matt British Gold PVD	29 P6 N409S
Matt Copper PVD	29 P9 N409S
超金色	29 01 N409S

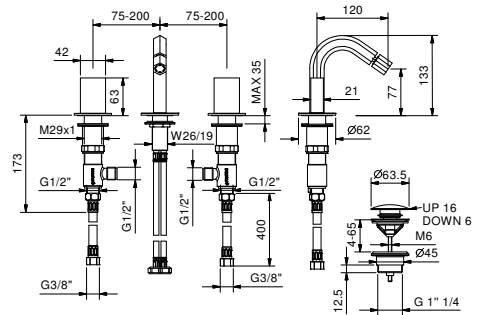

N509SW

三孔式妇洗器 - VENEZIA IN

- 龙头出水口长度13.5cm
- 不带开关把手
- 流速限制器 5升/分钟 3 bar
- 90°陶瓷阀芯
- 铰接式起泡器
- 供水软管
- 不带排水塞



注意：水龙头把手需要单独预定，请参看“开关把手”部分

铬色	29 02 N509SW
Polished Nickel PVD	29 95 N509SW
Matt Gun Metal PVD	29 P5 N509SW
Matt British Gold PVD	29 P6 N509SW
Matt Copper PVD	29 P9 N509SW
超金色	29 01 N509SW

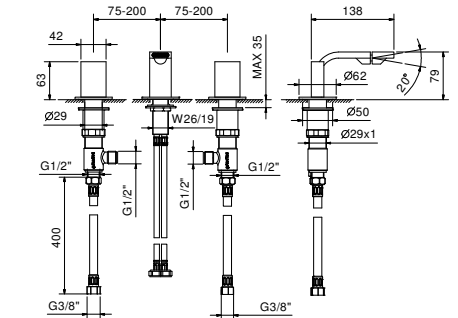

N509S

三孔式妇洗器 - VENEZIA IN

- 龙头出水口长度13.5cm
- 不带开关把手
- 流速限制器 5升/分钟 3 bar
- 90°陶瓷阀芯
- 铰接式起泡器
- 供水软管
- 按压式去水塞



注意：水龙头把手需要单独预定，请参看“开关把手”部分

铬色	29 02 N509S
Polished Nickel PVD	29 95 N509S
Matt Gun Metal PVD	29 P5 N509S
Matt British Gold PVD	29 P6 N509S
Matt Copper PVD	29 P9 N509S
超金色	29 01 N509S

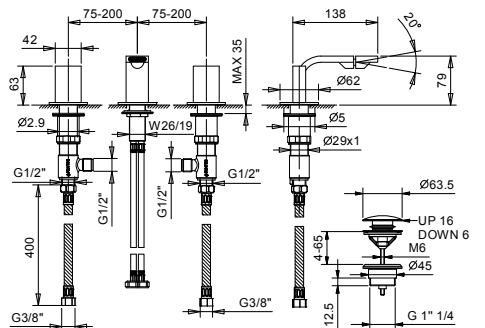

单孔式妇洗器

- 龙头出水口长度12cm
- 不带开关把手
- 墙装控制开关
- 流速限制器 5升/分钟 3 bar
- 90°陶瓷阀芯
- 铰接式起泡器
- 供水软管
- 按压式去水塞

注意：水龙头把手需要单独预定，请参看“开关把手”部分

N411SB



外部组件

铬色	29 02 N411SB
Polished Nickel PVD	29 95 N411SB
Matt Gun Metal PVD	29 P5 N411SB
Matt British Gold PVD	29 P6 N411SB
Matt Copper PVD	29 P9 N411SB
超金色	29 01 N411SB

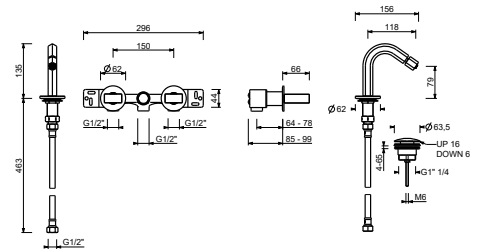

R011A



墙内预埋组件

44 00 R011A

单孔式妇洗器 - VENEZIA IN

- 龙头出水口长度13,2cm
- 不带开关把手
- 墙装控制开关
- 流速限制器 5升/分钟 3 bar
- 90°陶瓷阀芯
- 铰接式起泡器
- 供水软管
- 按压式去水塞

注意：水龙头把手需要单独预定，请参看“开关把手”部分

N511SB



外部组件

铬色	29 02 N511SB
Polished Nickel PVD	29 95 N511SB
Matt Gun Metal PVD	29 P5 N511SB
Matt British Gold PVD	29 P6 N511SB
Matt Copper PVD	29 P9 N511SB
超金色	29 01 N511SB

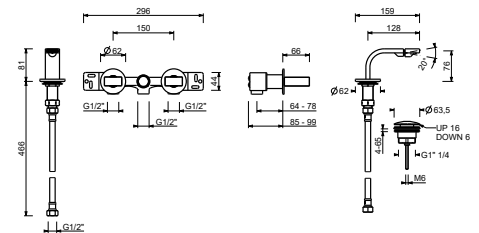

R011A



墙内预埋组件

44 00 R011A

N462SWF

单孔式妇洗器

- 龙头出水口长度12cm
- 不带开关把手
- 流速限制器 5升/分钟 3 bar
- 90°陶瓷阀芯
- 铰接式起泡器
- 供水软管
- 不带排水塞

注意：水龙头把手需要单独预定，请参看“开关把手”部分

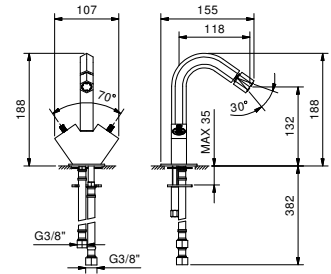

铬色	29 02 N462SWF
Polished Nickel PVD	29 95 N462SWF
Matt Gun Metal PVD	29 P5 N462SWF
Matt British Gold PVD	29 P6 N462SWF
Matt Copper PVD	29 P9 N462SWF
超金色	29 01 N462SWF

N462SF

单孔式妇洗器

- 龙头出水口长度12cm
- 不带开关把手
- 流速限制器 5升/分钟 3 bar
- 90°陶瓷阀芯
- 铰接式起泡器
- 供水软管
- 按压式去水塞

注意：水龙头把手需要单独预定，请参看“开关把手”部分

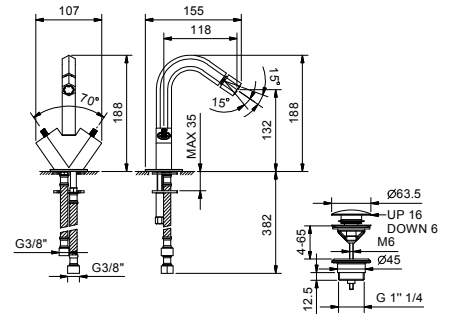

铬色	29 02 N462SF
Polished Nickel PVD	29 95 N462SF
Matt Gun Metal PVD	29 P5 N462SF
Matt British Gold PVD	29 P6 N462SF
Matt Copper PVD	29 P9 N462SF
超金色	29 01 N462SF

8486

两功能水刷

- 用于清洁马桶
- 用于个人卫生清洁，配合淋浴开关使用
- 带手持花洒托架的取水栓
- 止水阀
- 基材：黄铜
- 圆形底座
- 120cm PVC软管
- 1/2" 寸入水管

备注：价格表末尾杂项部分中的完整整理表

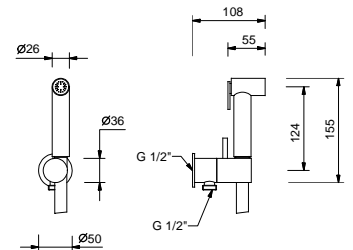

铬色	91 02 8486
Polished Nickel PVD	91 95 8486
Matt Gun Metal PVD	91 P5 8486
Matt British Gold PVD	91 P6 8486
Matt Copper PVD	91 P9 8486
超金色	91 01 8486

渐进式新型阀芯 渐进式新型阀芯

预埋式淋浴混合器
_1/2" 寸入水管



N385SB+6185A+N448C5
双出水口

恒温阀芯

预埋式淋浴混合器
_3/4" 寸入水管

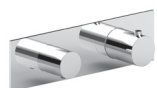

G531B+D331A
单出水口

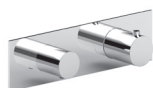

G572B+D372A
双出水口

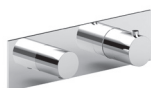

G573B+D373A
三出水口



G500B+D400A



N291SB+D391A+N448C5
止水阀

预埋式淋浴开关

- 墙外部分包括分水器开关
- 不带开关把手
- 旋钮式带关闭2向分水器
- 1/2" 寸入水管

注意：水龙头把手需要单独预定，请参看“开关把手”部分

N385SB

外部组件

铬色	29 02 N385SB
Polished Nickel PVD	29 95 N385SB
Matt Gun Metal PVD	29 P5 N385SB
Matt British Gold PVD	29 P6 N385SB
Matt Copper PVD	29 P9 N385SB
超金色	29 01 N385SB

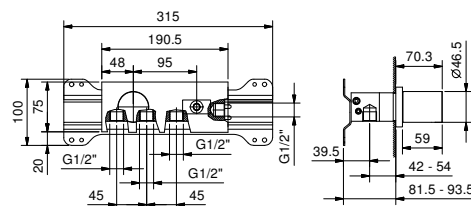

6185A

墙内预埋组件

19 00 6185A



3/4"寸管径预埋式恒温开关

- 开关手柄
- 1/2"寸管径单出水口
- 只可横向安装
- 3/4" 寸入水管

G531B

外部组件

铬色	87 02 G531B
Polished Nickel PVD	87 95 G531B
Matt Gun Metal PVD	87 P5 G531B
Matt British Gold PVD	87 P6 G531B
Matt Copper PVD	87 P9 G531B
超金色	87 01 G531B

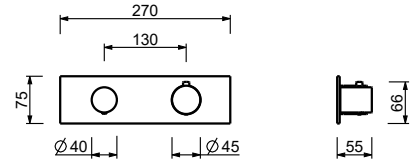
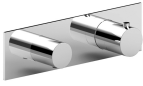

D331A

墙内预埋组件

19 00 D331A

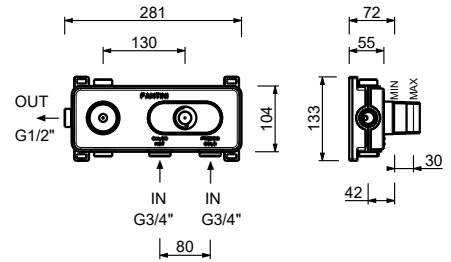

3/4"寸管径预埋式恒温开关

- 开关手柄
- 旋钮式带关闭2向分水器
- 只可横向安装
- 3/4" 寸入水管

G572B

外部组件

铬色	87 02 G572B
Polished Nickel PVD	87 95 G572B
Matt Gun Metal PVD	87 P5 G572B
Matt British Gold PVD	87 P6 G572B
Matt Copper PVD	87 P9 G572B
超金色	87 01 G572B

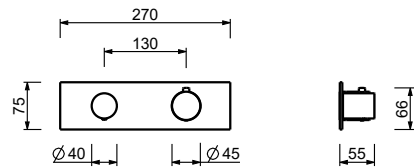
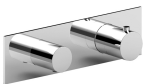

D372A

墙内预埋组件

19 00 D372A

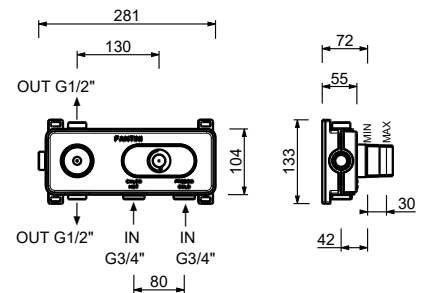

3/4"寸管径预埋式恒温开关

- 开关手柄
- 旋钮式带关闭3向分水器
- 只可横向安装
- 3/4" 寸入水管

G573B

外部组件

铬色	87 02 G573B
Polished Nickel PVD	87 95 G573B
Matt Gun Metal PVD	87 P5 G573B
Matt British Gold PVD	87 P6 G573B
Matt Copper PVD	87 P9 G573B
超金色	87 01 G573B

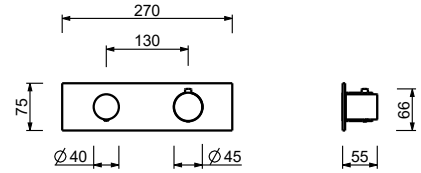
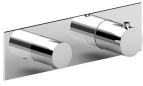

D373A

墙内预埋组件

19 00 D373A

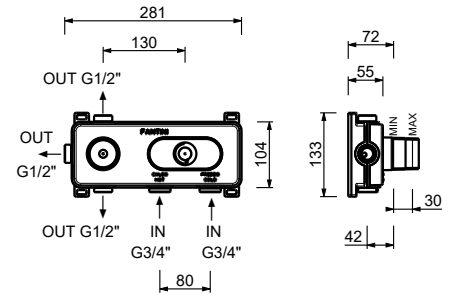

3/4"寸管径预埋式恒温开关

- 开关手柄
- 3/4" 寸入水管
- 静音系统
- 不带止流阀 需要单独预定

注意：混合水龙头必须与止流阀一同订购产品编号：N291SB+D391A

G500B

外部组件

铬色	87 02 G500B
Polished Nickel PVD	87 95 G500B
Matt Gun Metal PVD	87 P5 G500B
Matt British Gold PVD	87 P6 G500B
Matt Copper PVD	87 P9 G500B
超金色	87 01 G500B

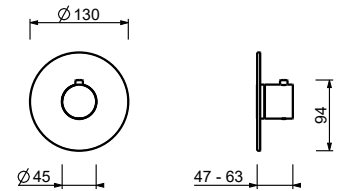

D400A

墙内预埋组件

19 00 D400A

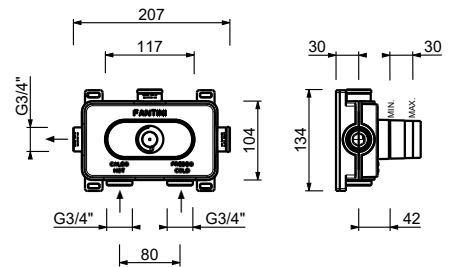

3/4" 寸管径止水阀

- 不带开关把手
- 90°陶瓷阀芯
- 3/4" 寸入水管

注意：水龙头把手需要单独预定，请参看“开关把手”部分

N291SB



外部组件

铬色	29 02 N291SB
Polished Nickel PVD	29 95 N291SB
Matt Gun Metal PVD	29 P5 N291SB
Matt British Gold PVD	29 P6 N291SB
Matt Copper PVD	29 P9 N291SB
超金色	29 01 N291SB

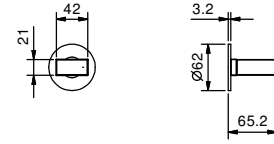

D391A



墙内预埋组件

19 00 D391A

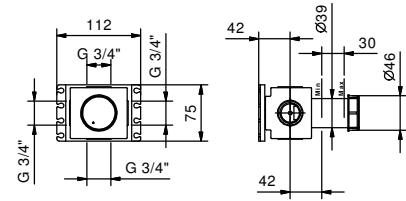

W213

选配 - 简易安装系统

- 板和连接：
- 为了便于安装水平和垂直恒温淋浴开关：
 - 安装一路出水，型号 D400A/D391A
 - 安装两路出水，型号 D400A/D391A

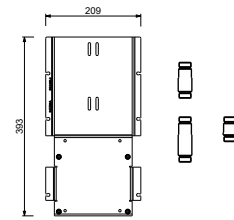

一路出水组合示例



两路出水组合示例



W214

选配 - 简易安装系统

板和连接：

- 为了便于安装水平和垂直恒温淋浴开关：
- 安装三路出水，型号 D400A/D391A

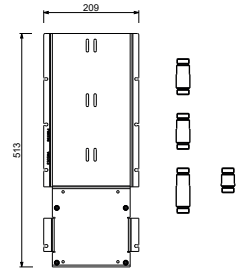
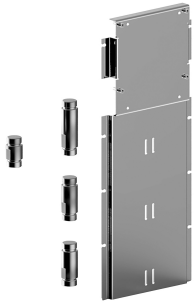

三路出水组合示例



91 00 W214

8083

雨式花洒

- 直径24cm
- 基材：不锈钢
- 流速限制器12升/分钟 3 bar
- 防钙化系统
- 1/2" 寸入水管
- 止回阀

注意：保证产品正确运行的必要条件 水流量不小于：10升/分钟

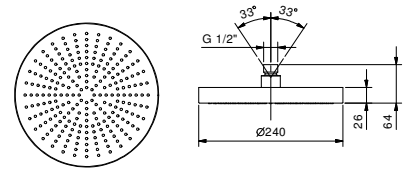

铬色	86 02 8083
Polished Nickel PVD	86 95 8083
Matt Gun Metal PVD	86 P5 8083
Matt British Gold PVD	86 P6 8083
Matt Copper PVD	86 P9 8083
超金色	86 01 8083

8142

雨式花洒

- 直径24cm
- 基材：ABS
- 流速限制器12升/分钟 3 bar
- 防钙化系统
- 1/2" 寸入水管
- 止回阀

注意：保证产品正确运行的必要条件 水流量不小于：10升/分钟

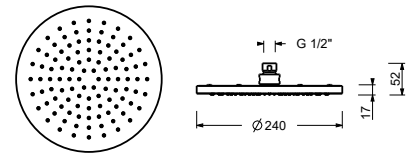
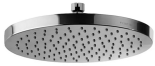

铬色	86 02 8142
Polished Nickel PVD	86 95 8142
Matt Gun Metal PVD	86 P5 8142
Matt British Gold PVD	86 P6 8142
Matt Copper PVD	86 P9 8142
超金色	86 01 8142

8146

雨式花洒

- 直径25cm
- 基材：不锈钢
- 流速限制器12升/分钟 3 bar
- 防钙化系统
- 1/2" 寸入水管
- 止回阀

注意：保证产品正确运行的必要条件 水流量不小于：10升/分钟

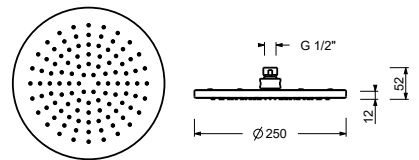

铬色	86 02 8146
Polished Nickel PVD	86 95 8146
Matt Gun Metal PVD	86 P5 8146
Matt British Gold PVD	86 P6 8146
Matt Copper PVD	86 P9 8146
超金色	86 01 8146

K073

雨式花洒

- ACQUAFIT
- 水功能：
- 第一个功能：240 个防水垢喷嘴
- 直径30cm
- 基材：不锈钢
- 止回阀
- 流速限制器 14升/分钟 3 bar
- 防钙化系统
- 1/2" 寸入水管

注意：保证产品正确运行的必要条件：水流量不小于：12升/分钟

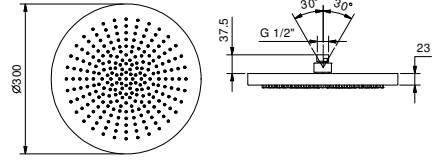

不锈钢抛光色	79 38 K073
Polished Nickel PVD	79 95 K073
Matt Gun Metal PVD	79 P5 K073
Matt British Gold PVD	79 P6 K073
Matt Copper PVD	79 P9 K073
超金色	79 01 K073

8084

雨式花洒

- 直径36cm
- 基材：不锈钢
- 防钙化系统
- 1/2" 寸入水管
- 止回阀

注意：保证产品正确运行的必要条件：
水流量不小于：15升/分钟

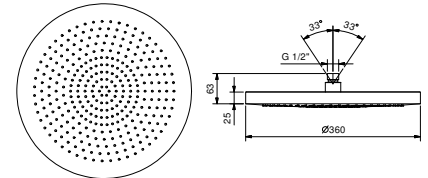

铬色	86 02 8084
----	------------

双头花洒

- 雨式
- 瀑布式
- 基材：黄铜
- 墙面装
- 流速限制器17升/分钟 3 bar
- 防钙化系统
- 1/2" 寸入水管
- 最小流速 12升/分钟

注意：保证产品正确运行的必要条件：水流量不小于：12升/分钟

8035B

外部组件

铬色	86 02 8035B
Polished Nickel PVD	86 95 8035B
Matt Gun Metal PVD	86 P5 8035B
Matt British Gold PVD	86 P6 8035B
Matt Copper PVD	86 P9 8035B
超金色	86 01 8035B



8035A

墙内预埋组件

86 00 8035A

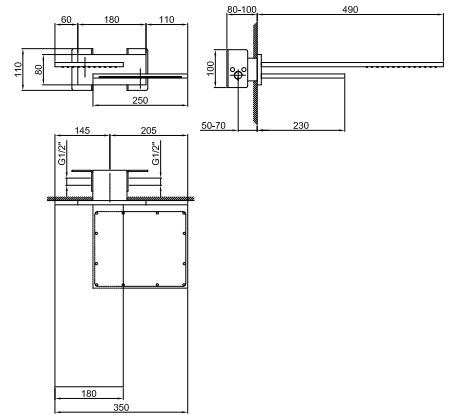

8137

花洒臂

- 长度35cm
- 圆形底座
- 墙面装
- 1/2" 寸入水管



铬色	86 02 8137
Polished Nickel PVD	86 95 8137
Matt Gun Metal PVD	86 P5 8137
Matt British Gold PVD	86 P6 8137
Matt Copper PVD	86 P9 8137
超金色	86 01 8137

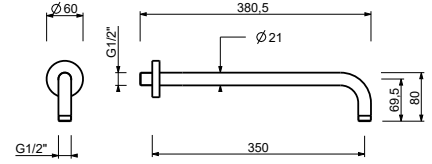

选配: 适用石膏板的预埋件

W046 91 00 W046

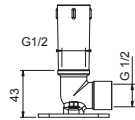

8028

花洒臂

- 长度45cm
- 圆形底座
- 墙面装
- 1/2" 寸入水管



铬色	86 02 8028
Polished Nickel PVD	86 95 8028
Matt Gun Metal PVD	86 P5 8028
Matt British Gold PVD	86 P6 8028
Matt Copper PVD	86 P9 8028
超金色	86 01 8028

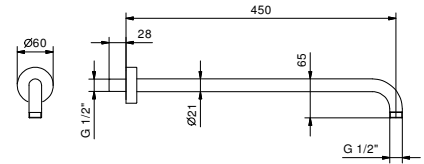

选配: 适用石膏板的预埋件

W046 91 00 W046

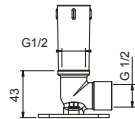

9231

花洒臂

- 长度30cm
- 圆形底座
- 墙面装
- 1/2" 寸入水管



铬色	86 02 9231
Polished Nickel PVD	86 95 9231
Matt Gun Metal PVD	86 P5 9231
Matt British Gold PVD	86 P6 9231
Matt Copper PVD	86 P9 9231
超金色	86 01 9231

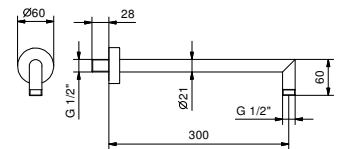

选配: 适用石膏板的预埋件

W046 91 00 W046

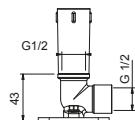

8011

花洒臂

- 长度45cm
- 圆形底座
- 墙面装
- 1/2" 寸入水管



铬色	86 02 8011
Polished Nickel PVD	86 95 8011
Matt Gun Metal PVD	86 P5 8011
Matt British Gold PVD	86 P6 8011
Matt Copper PVD	86 P9 8011
超金色	86 01 8011

选配: 适用石膏板的预埋件

W046 91 00 W046

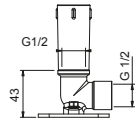
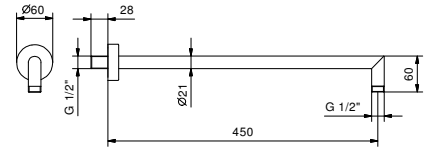

9236

花洒臂

- 长度25cm
- 圆形底座
- 天花板吊顶安装
- 1/2" 寸入水管



铬色	86 02 9236
Polished Nickel PVD	86 95 9236
Matt Gun Metal PVD	86 P5 9236
Matt British Gold PVD	86 P6 9236
Matt Copper PVD	86 P9 9236
超金色	86 01 9236

选配: 适用石膏板的预埋件

W046 91 00 W046

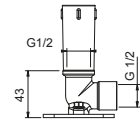
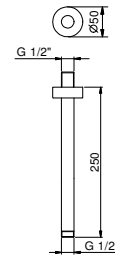

9237

花洒臂

- 长度45cm
- 圆形底座
- 天花板吊顶安装
- 1/2" 寸入水管



铬色	86 02 9237
Polished Nickel PVD	86 95 9237
Matt Gun Metal PVD	86 P5 9237
Matt British Gold PVD	86 P6 9237
Matt Copper PVD	86 P9 9237
超金色	86 01 9237

选配: 适用石膏板的预埋件

W046 91 00 W046

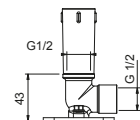
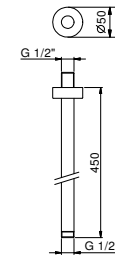

5943

整套淋浴

- VENEZIA系列手持花洒
- 带手持花洒托架的取水栓
- 圆形底座
- 150cm黄铜软管
- 140cm黄铜软管, PVD 选配
- 1/2" 寸入水管

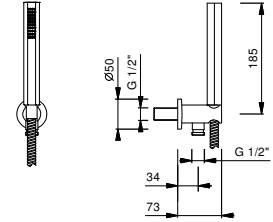

铬色	29 02 5943
Polished Nickel PVD	29 95 5943
Matt Gun Metal PVD	29 P5 5943
Matt British Gold PVD	29 P6 5943
Matt Copper PVD	29 P9 5943
超金色	29 01 5943

5944

整套淋浴

- FIT系列手持花洒
- 带手持花洒托架的取水栓
- 圆形底座
- 150cm黄铜软管
- 140cm黄铜软管, PVD 选配
- 1/2" 寸入水管

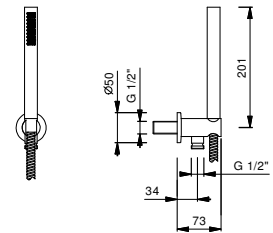

铬色	29 02 5944
Polished Nickel PVD	29 95 5944
Matt Gun Metal PVD	29 P5 5944
Matt British Gold PVD	29 P6 5944
Matt Copper PVD	29 P9 5944
超金色	29 01 5944

9849

手持花洒

- VENEZIA系列
- 流速限制器 9升/分钟
- 防钙化系统
- 止回阀

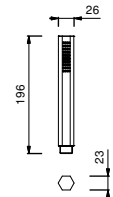

铬色	90 02 9849
Polished Nickel PVD	90 95 9849
Matt Gun Metal PVD	90 P5 9849
Matt British Gold PVD	90 P6 9849
Matt Copper PVD	90 P9 9849
超金色	90 01 9849

8783

手持花洒

- FIT 系列
- 基材：黄铜
- 流速限制器 9升/分钟
- 防钙化系统
- 止回阀

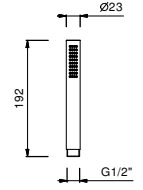

铬色	90 02 8783
Polished Nickel PVD	90 95 8783
Matt Gun Metal PVD	90 P5 8783
Matt British Gold PVD	90 P6 8783
Matt Copper PVD	90 P9 8783
超金色	90 01 8783

9248

侧边身体按摩喷雾

- 基材：黄铜
- 可调节方向
- 防钙化系统
- 1/2" 寸入水管

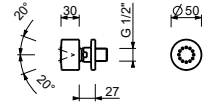

铬色	86 02 9248
Polished Nickel PVD	86 95 9248
Matt Gun Metal PVD	86 P5 9248
Matt British Gold PVD	86 P6 9248
Matt Copper PVD	86 P9 9248
超金色	86 01 9248

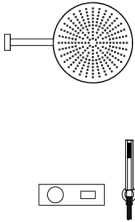
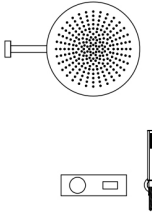
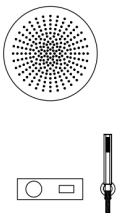
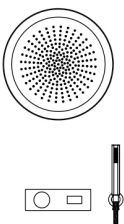
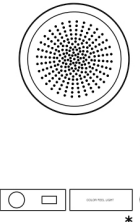
组合.1	款式.	描述	漆面
	8083 8027 N385SB+6185A N448 5943	雨式花洒 花洒臂 预埋式淋浴开关 VENEZIA系列手柄 整套淋浴	02 铬色 95 Polished Nickel PVD P5 Matt Gun Metal PVD P6 Matt British Gold PVD P9 Matt Copper PVD 01 超金色
	组合.2	款式.	描述
	K073 8027 N385SB+6185A N448 5943	雨式花洒 花洒臂 预埋式淋浴开关 VENEZIA系列手柄 整套淋浴	02 铬色 95 Polished Nickel PVD P5 Matt Gun Metal PVD P6 Matt British Gold PVD P9 Matt Copper PVD 01 超金色
	组合.3	款式.	描述
	K072 N385SB+6185A N448 5943	雨式花洒 预埋式淋浴开关 VENEZIA系列手柄 整套淋浴	02 铬色 95 Polished Nickel PVD P5 Matt Gun Metal PVD P6 Matt British Gold PVD P9 Matt Copper PVD 01 超金色
	组合.4	款式.	描述
	K062 N385SB+6185A N448 5943	雨式花洒 预埋式淋浴开关 VENEZIA系列手柄 整套淋浴	02 铬色 95 Polished Nickel PVD P5 Matt Gun Metal PVD P6 Matt British Gold PVD P9 Matt Copper PVD 01 超金色
	组合.5	款式.	描述
	K061 K101 OPT. N385SB+6185A N448 5943	多功能花洒 Dream 触摸式控制键盘 预埋式淋浴开关 VENEZIA系列手柄 整套淋浴	02 铬色 95 Polished Nickel PVD P5 Matt Gun Metal PVD P6 Matt British Gold PVD P9 Matt Copper PVD 01 超金色 *选配 K101 触摸式控制键盘

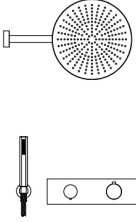
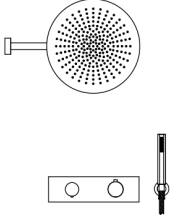
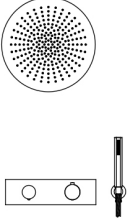
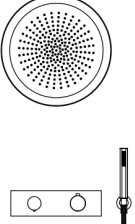
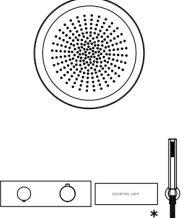
组合.1	款式.	描述	漆面
	8083 8027 G572B+D372A 5943	雨式花洒 花洒臂 3/4"寸管径预埋式恒温开关 整套淋浴	02 铬色 95 Polished Nickel PVD P5 Matt Gun Metal PVD P6 Matt British Gold PVD P9 Matt Copper PVD 01 超金色
组合.2	款式.	描述	漆面
	K073 8027 G572B+D372A 5943	雨式花洒 花洒臂 3/4"寸管径预埋式恒温开关 整套淋浴	02 铬色 95 Polished Nickel PVD P5 Matt Gun Metal PVD P6 Matt British Gold PVD P9 Matt Copper PVD 01 超金色
组合.3	款式.	描述	漆面
	K072 5943 G572B+D372A	雨式花洒 整套淋浴 3/4"寸管径预埋式恒温开关	02 铬色 95 Polished Nickel PVD P5 Matt Gun Metal PVD P6 Matt British Gold PVD P9 Matt Copper PVD 01 超金色
组合.4	款式.	描述	漆面
	K062 5943 G572B+D372A	雨式花洒 整套淋浴 3/4"寸管径预埋式恒温开关	02 铬色 95 Polished Nickel PVD P5 Matt Gun Metal PVD P6 Matt British Gold PVD P9 Matt Copper PVD 01 超金色
组合.5	款式.	描述	漆面
	K061 K101 OPT. G572B+D372A 5943	多功能花洒 Dream 触摸式控制键盘 3/4"寸管径预埋式恒温开关 整套淋浴	02 铬色 95 Polished Nickel PVD P5 Matt Gun Metal PVD P6 Matt British Gold PVD P9 Matt Copper PVD 01 超金色 *选配 K101 触摸式控制键盘

1/4转陶瓷阀芯

预埋式浴缸龙头组

1/2" 寸入水管



N019SB+N019A+N448C5 (2 PZ)
双出水口



N017SB+N017A+N448C5 (2 PZ)
双出水口

预埋式浴缸龙头组

3/4" 寸入水管



N465S+N448C5 (2 PZ)
双出水口



N467S+N448C5 (2 PZ)
双出水口

缸边式龙头组- VENEZIA IN系列

3/4" 寸入水管



N565S+N448C5 (2 PZ)
双出水口

落地式浴缸龙头

1/2" 寸入水管



N080B+R080A
双出水口

落地式浴缸龙头 - VENEZIA IN系列

1/2" 寸入水管



N580SB+1680A+N448C5 (2 PZ)
双出水口

预埋式浴缸龙头

- 龙头出水口长度20cm
- 不带开关把手
- 旋钮式2向分水器
- VENEZIA系列手持花洒
- 带手持花洒托架的取水栓
- 150cm黄铜软管
- 140cm黄铜软管, PVD 选配
- 90°陶瓷阀芯
- 1/2" 寸入水管

N019SB



外部组件

铬色	29 02 N019SB
Polished Nickel PVD	29 95 N019SB
Matt Gun Metal PVD	29 P5 N019SB
Matt British Gold PVD	29 P6 N019SB
Matt Copper PVD	29 P9 N019SB
超金色	29 01 N019SB

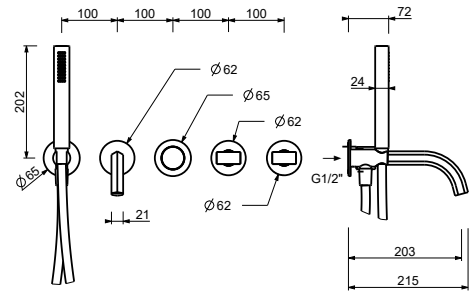

N019A



墙内预埋组件

44 00 N019A

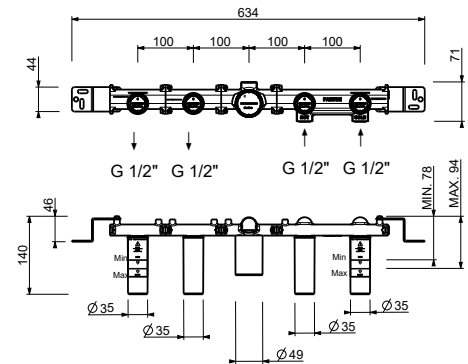

预埋式浴缸龙头

- 不带开关把手
- 不带龙头出水嘴
- 旋钮式2向分水器
- VENEZIA系列手持花洒
- 带手持花洒托架的取水栓
- 150cm黄铜软管
- 140cm黄铜软管, PVD 选配
- 90°陶瓷阀芯
- 1/2" 寸入水管

N017SB



外部组件

铬色	29 02 N017SB
Polished Nickel PVD	29 95 N017SB
Matt Gun Metal PVD	29 P5 N017SB
Matt British Gold PVD	29 P6 N017SB
Matt Copper PVD	29 P9 N017SB
超金色	29 01 N017SB

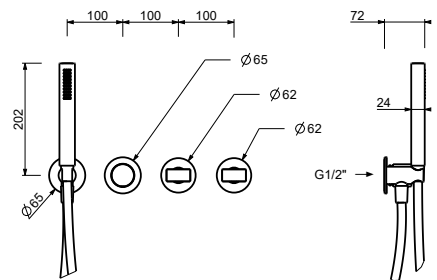

N017A



墙内预埋组件

44 00 N017A

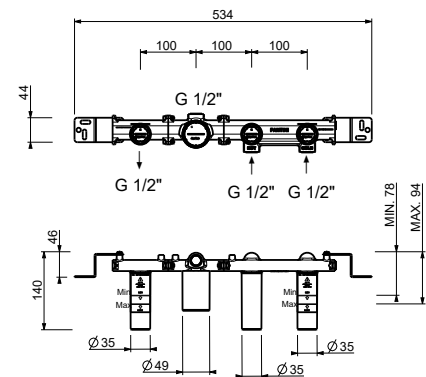

落地式浴缸龙头组 - VENEZIA IN

- 龙头出水口长度21.5cm
- 不带开关把手
- 按压式2向分水器
- FIT系列手持花洒
- 手持花洒托架
- 150cm黄铜软管
- 140cm黄铜软管，PVD 选配
- 90°陶瓷阀芯
- 1/2" 寸入水管
- 浴缸边落地柱

注意：水龙头把手需要单独预定，请参看“开关把手”部分

N580SB



1680A



外部组件

铬色	29 02 N580SB
Polished Nickel PVD	29 95 N580SB
Matt Gun Metal PVD	29 P5 N580SB
Matt British Gold PVD	29 P6 N580SB
Matt Copper PVD	29 P9 N580SB
超金色	29 01 N580SB

墙内预埋组件

19 00 1680A

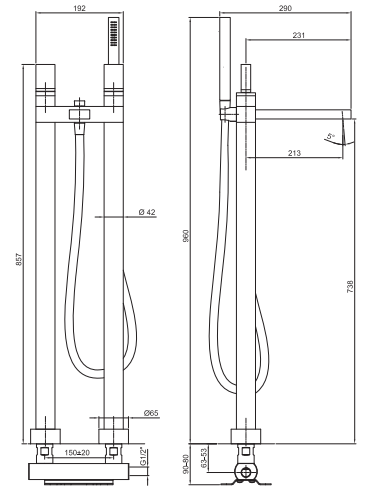

落地式浴缸混合龙头

- 龙头出水口长度25cm
- 开关手柄
- 带有流量和温度控制的开关手柄
- VENEZIA系列手持花洒
- 手持花洒托架
- 150cm PVC软管
- 1/2" 寸入水管
- 浴缸边落地柱

N080B



外部组件

铬色	29 02 N080B
Polished Nickel PVD	29 95 N080B
Matt Gun Metal PVD	29 P5 N080B
Matt British Gold PVD	29 P6 N080B
Matt Copper PVD	29 P9 N080B
超金色	29 01 N080B

R080A



墙内预埋组件

44 00 R080A

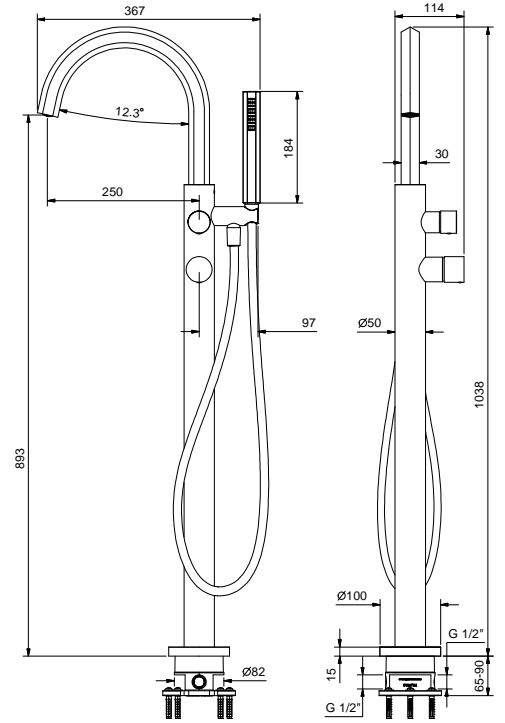

预埋式浴缸出水口

- 龙头出水口长度14.5cm
- 右手版
- 瀑布式
- 1/2" 寸入水管

5041B

外部组件

铬色	31 02 5041B
Polished Nickel PVD	31 95 5041B
Matt Gun Metal PVD	31 P5 5041B
Matt British Gold PVD	31 P6 5041B
Matt Copper PVD	31 P9 5041B
超金色	31 01 5041B

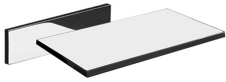

5041A

墙内预埋组件

31 00 5041A

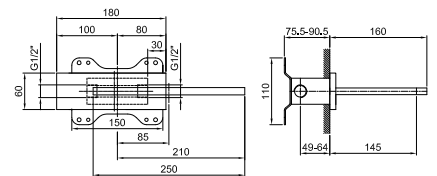

预埋式浴缸出水口

- 龙头出水口长度14.5cm
- 左手版
- 瀑布式
- 1/2" 寸入水管

5042B

外部组件

铬色	31 02 5042B
Polished Nickel PVD	31 95 5042B
Matt Gun Metal PVD	31 P5 5042B
Matt British Gold PVD	31 P6 5042B
Matt Copper PVD	31 P9 5042B
超金色	31 01 5042B

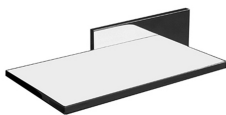

5041A

墙内预埋组件

31 00 5041A

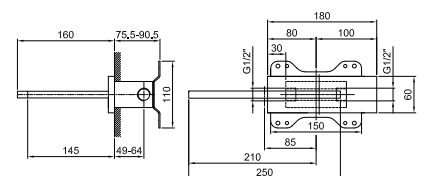

8315

墙装式浴缸出水口

- 龙头出水口长度20cm
- 圆形底座
- 1/2" 寸入水管



铬色	29 02 8315
Polished Nickel PVD	29 95 8315
Matt Gun Metal PVD	29 P5 8315
Matt British Gold PVD	29 P6 8315
Matt Copper PVD	29 P9 8315
超金色	29 01 8315

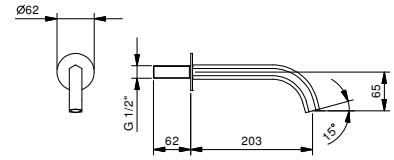

C945

墙装式浴缸出水口

- 龙头出水口长度19cm
- 圆形底座
- 1/2" 寸入水管

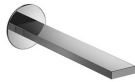

铬色	29 02 C945
Polished Nickel PVD	29 95 C945
Matt Gun Metal PVD	29 P5 C945
Matt British Gold PVD	29 P6 C945
Matt Copper PVD	29 P9 C945
超金色	29 01 C945

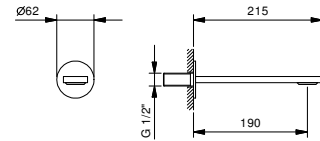

8418

落地式浴缸出水口

- 龙头出水口长度24cm
- 1/2" 寸入水管



铬色	29 02 8418
Polished Nickel PVD	29 95 8418
Matt Gun Metal PVD	29 P5 8418
Matt British Gold PVD	29 P6 8418
Matt Copper PVD	29 P9 8418
超金色	29 01 8418

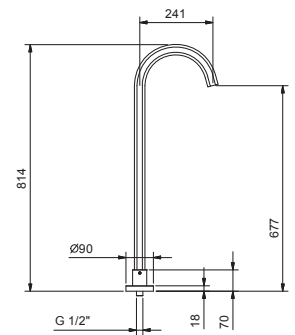

8434

排水塞

- 1" 1/4
- 按压式去水塞
- 不带防溢孔的面盆
- 用于带防溢孔的面盆
- 通用的

备注：价格表末尾杂项部分中的完整整理表



铬色	91 02 8434
Polished Nickel PVD	91 95 8434
Matt Gun Metal PVD	91 P5 8434
Matt British Gold PVD	91 P6 8434
Matt Copper PVD	91 P9 8434
超金色	91 01 8434

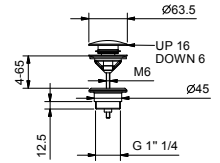

8435

排水塞

- 1" 1/4
- 不带防溢孔的面盆
- 用于带防溢孔的面盆
- 自由出水
- 通用的

备注：价格表末尾杂项部分中的完整整理表



铬色	91 02 8435
Polished Nickel PVD	91 95 8435
Matt Gun Metal PVD	91 P5 8435
Matt British Gold PVD	91 P6 8435
Matt Copper PVD	91 P9 8435
超金色	91 01 8435

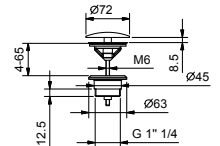

9234

瓶式虹吸

- 1" 1/4
- 用于面盆

备注：价格表末尾杂项部分中的完整整理表



铬色	91 02 9234
Polished Nickel PVD	91 95 9234
Matt Gun Metal PVD	91 P5 9234
Matt British Gold PVD	91 P6 9234
Matt Copper PVD	91 P9 9234
超金色	91 01 9234

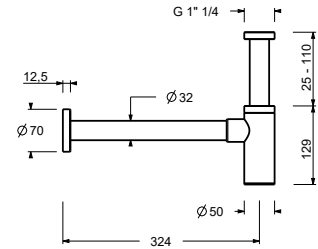

8364

双过滤阀

- 带闭合开关
- 可拆卸过滤装置
- 1/2" 寸入水管

备注：价格表末尾杂项部分中的完整整理表



铬色	91 02 8364
Polished Nickel PVD	91 95 8364
Matt Gun Metal PVD	91 P5 8364
Matt British Gold PVD	91 P6 8364
Matt Copper PVD	91 P9 8364
超金色	91 01 8364

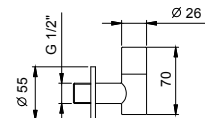

8402

冲水控制板

- 基材：不锈钢
- 凸出的控制按钮
- 带圆形按钮
- 与GEBERIT SIGMA8, SIGMA12匹配
- 无可视固定装置

备注：价格表末尾杂项部分中的完整整理表

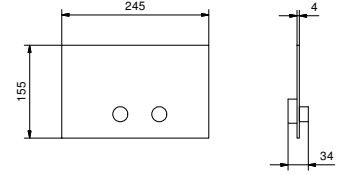

不锈钢抛光色	91 38 8402
Polished Nickel PVD	91 95 8402
Matt Gun Metal PVD	91 P5 8402
Matt British Gold PVD	91 P6 8402
Matt Copper PVD	91 P9 8402
超金色	91 01 8402

8403

冲水控制板

- 基材：不锈钢
- 线式控制
- 带方形按钮
- 与GEBERIT SIGMA8, SIGMA12匹配
- 无可视固定装置

备注：价格表末尾杂项部分中的完整整理表

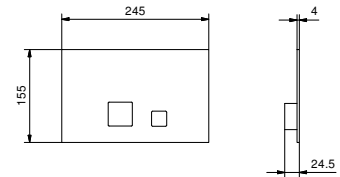

不锈钢抛光色	91 38 8403
Polished Nickel PVD	91 95 8403
Matt Gun Metal PVD	91 P5 8403
Matt British Gold PVD	91 P6 8403
Matt Copper PVD	91 P9 8403
超金色	91 01 8403

W216

冲水控制板

- 基材：不锈钢
- 凸出的控制按钮
- 带圆形按钮
- 与TECEBOX OCTA II匹配
- 最小深度：请参见安装说明
- 无可视固定装置

备注：价格表末尾杂项部分中的完整整理表

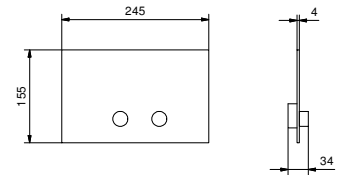

不锈钢抛光色	91 38 W216
Polished Nickel PVD	91 95 W216
Matt Gun Metal PVD	91 P5 W216
Matt British Gold PVD	91 P6 W216
Matt Copper PVD	91 P9 W216
超金色	91 01 W216

8486

两功能水刷

- 用于清洁马桶
- 用于个人卫生清洁，配合淋浴开关使用
- 带手持花洒托架的取水栓
- 止水阀
- 基材：黄铜
- 圆形底座
- 120cm PVC软管
- 1/2" 寸入水管



备注：价格表末尾杂项部分中的完整整理表

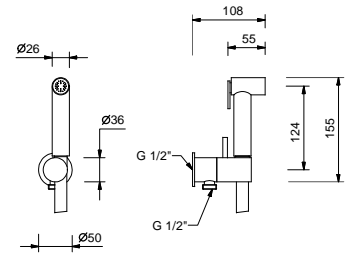

铬色	91 02 8486
Polished Nickel PVD	91 95 8486
Matt Gun Metal PVD	91 P5 8486
Matt British Gold PVD	91 P6 8486
Matt Copper PVD	91 P9 8486
超金色	91 01 8486

W001

浴缸排水柱

- 带开关把手
- 带排水

备注：价格表末尾杂项部分中的完整整理表



铬色	91 02 W001
Polished Nickel PVD	91 95 W001
Matt Gun Metal PVD	91 P5 W001
Matt British Gold PVD	91 P6 W001
Matt Copper PVD	91 P9 W001
超金色	91 01 W001

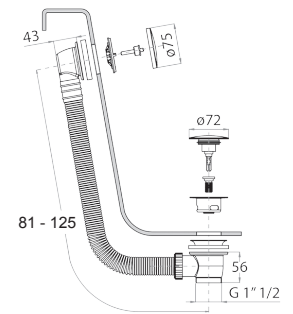

W002

浴缸排水柱

- 带开关把手
- 浴缸防溢排水口
- 带排水

备注：价格表末尾杂项部分中的完整整理表



铬色	91 02 W002
Polished Nickel PVD	91 95 W002
Matt Gun Metal PVD	91 P5 W002
Matt British Gold PVD	91 P6 W002
Matt Copper PVD	91 P9 W002
超金色	91 01 W002

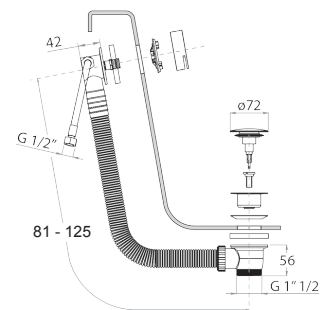

9325

缸边混合龙头安装板

- 螺丝盖
- 安装板
- 不带遮盖板

注意：需要用可拆卸检查的覆盖板来完善

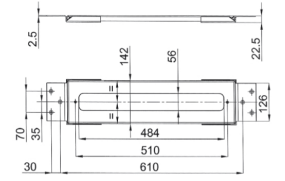

铬色

91 02 9325

9670

缸边混合龙头安装板

- 螺丝盖
- 安装板
- 不带遮盖板

注意：需要用可拆卸检查的覆盖板来完善

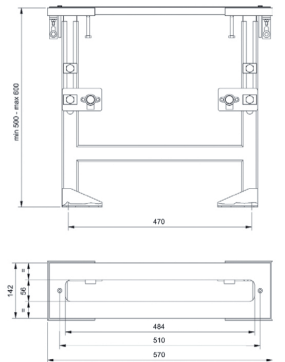

铬色

91 02 9670