

ABOUTWATER

AF/21

Instructions / Instrucciones

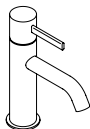

ART. A704WU

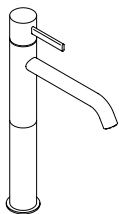

ART. A706WU

Tools needed / Instrumentos necesarios

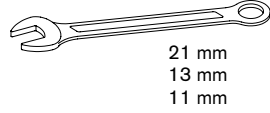
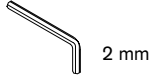

Index / Índice

Flexible mounting / Montaje flexible	4
A704WU Washbasin / Lavabo.....	6
A706WU Washbasin / Lavabo.....	8
Adjustments / Ajustes.....	10
Cartridge replacement / Sustitucion del cartucho.....	11
Substitute aerator / Sustituir el aireador.....	12
Technical data / Datos Técnicos.....	13

Flexible mounting / Montaje flexible



Before installation, check presence and integrity of the clamping of the side tubes.

/ Antes de la instalación, verificar la presencia y la integridad de los acoples de los tubos flexibles de ambos lados.



Hand-tighten O-ring seal connectors. Max torque 3 Nm.

/ Enrosacar los empalmes de junta tórica manualmente. Par máximo de ajuste 3 Nm.

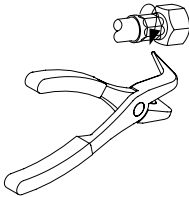

Do not tighten by inappropriate tools or in inappropriate ways.

/ No ajustar con herramientas inadecuadas o en puntos incorrectos.

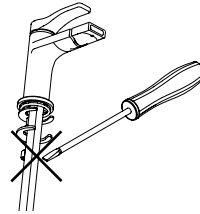

Do not expose the hose to lateral stress nor overtight by any tool.

(Ex.: during the installation of the faucet stud or the drain pop-up lever).

/ Después del montaje, evitar tensiones laterales aunque sean mínimas, con cualquier herramienta. (Ej.: durante la fijación de tirante o varilla dosificadora).

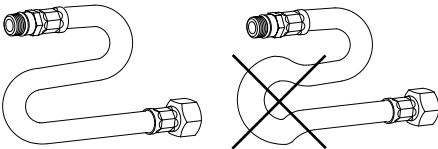

Maintain minimum bend radius.

/ Respetar el radio mínimo de curvatura.

DN6 = 1"

DN8 = 1"3/16

DN10 = 1"3/8

DN13 = 1"25/32

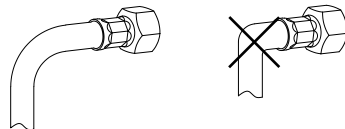

Before bending the hose please consider a straight part of at least 1,5-2 times the external diameter.

/ Antes del comienzo de la curvatura dejar un tramo rectilíneo de 1,5 - 2 veces el diámetro externo como mínimo.

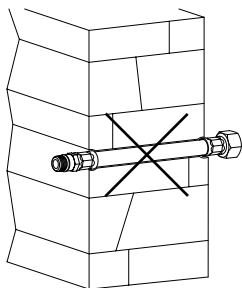

Do not set the hose in the wall.

/ No empotrar el conducto en el muro.

7.

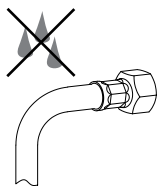

Prolonged contact with any substance, even scarcely aggressive, can cause external braid damage and subsequent flexible burst.

/ El contacto prolongado con sustancias, aunque sean mínimamente agresivas, puede determinar el daño del trenzado y el consiguiente reventón del tubo flexible.

9.



Tighten the hose without any twist or tension.

/ No instalar el tubo flexible en torsión o en tensión.

8.

Do not connect the electric grounding to the flexible hose nor to any other water piping.

Turn off the plumbing in case of long absence. Replace the hose in case of leakage and anyway.

/ No conectar la puesta a tierra de la instalación eléctrica al tubo flexible o a otra tubería hidráulica.

Cerrar la instalación hidráulica en caso de ausencia prolongada.

Reemplazar el tubo flexible en caso de pequeñas pérdidas.

10.

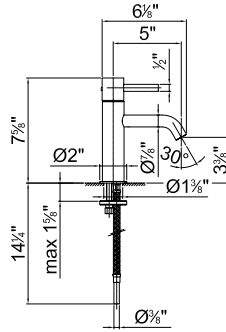
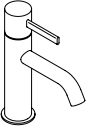

ART. A704WU Washbasin / Lavabo

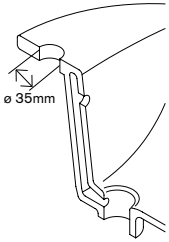

1.

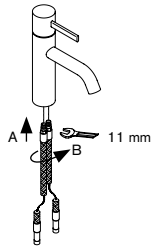

2.

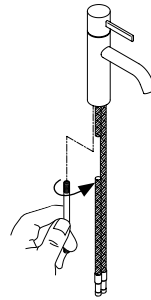

3.

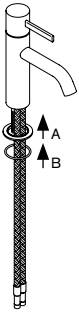

4.

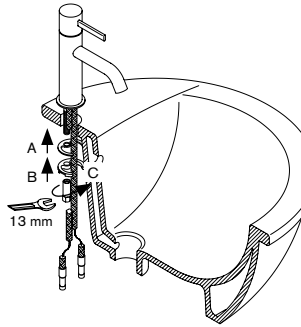

5.

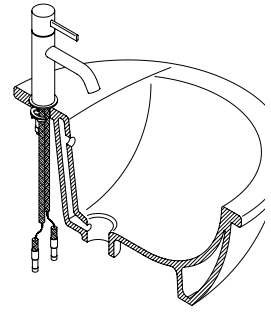

6.

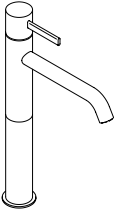

ART. A706WU Washbasin / Lavabo

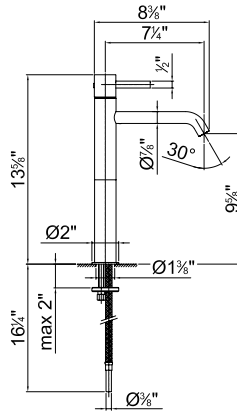

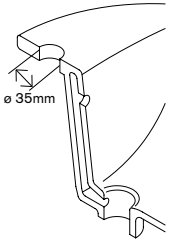

1.

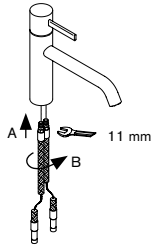

2.

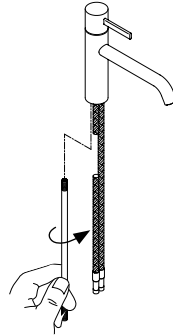

3.

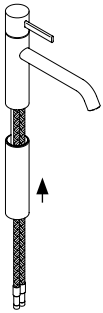

4.

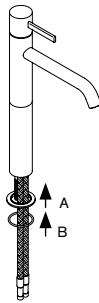

5.

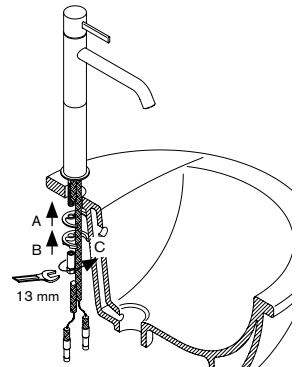

6.

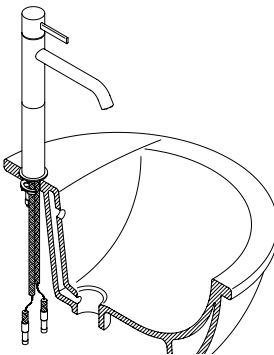

7.

Adjustments / Ajustes

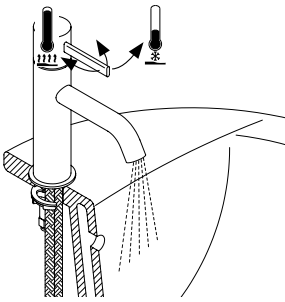

1.

Cartridge replacement / Sustitucion del cartucho

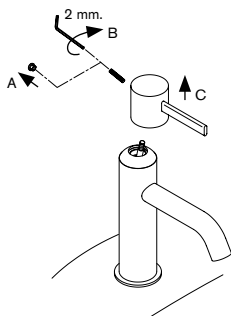
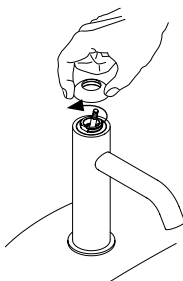
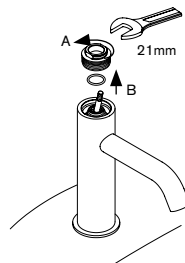
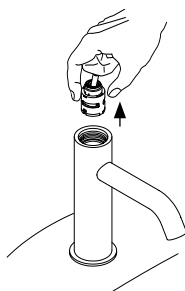
1.2.3.4.

Replace following the instructions in reverse order (4-3-2-1). Tighten the ring (3) with a pair of 10+12 Nm.

Colocar según el procedimiento inverso (4-3-2-1). Apretar la tuerca (3) con un par de 10+12 Nm.

Substitute aerator / Sustituir el aireador

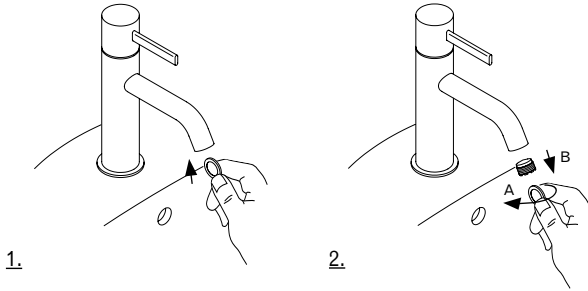

Replace following the instructions in reverse order (2-1)
Colocar según el procedimiento inverso (2-1)

Technical data

Minimum pressure	14 PSI
Maximum pressure	145 PSI
Reccomended working pressure	30-70 PSI
Maximum water temperature	176°F
Maximum water temperature reccomended	150°F
Maximum in-let pressure difference (hot - cold)	22 PSI

Operating instructions

These mixers can be used with cumulos boilers or instantaneous water heaters.

Warning

The supplying pipes must be carefully cleaned before installation.

Remember that the hot water supply must **ALWAYS** be connected to the tube on the **LEFT**.

ENGLAND.

Datos Técnicos

Presion mínima	14 PSI
Presion máxima	145 PSI
Presion de trabajo aconsejada	30-70 PSI
Temperatura máxima	176°F
Temperatura máxima aconsejada	150°F
Diferencial maxima de presiún de entrada (caliente - fria)	22 PSI

Aplicaciones

Estos monomandos pueden ser utilizados con acumuladores de agua caliente a presión.

Advertencias

Antes de conectar el monomando es necesario purgar correctamente la instalaciún hidráulica de alimentaciún de cualquier impureza que pueda tener.

Recuerde que el agua caliente debe ser **SIEMPRE** conectada al tubo o flexo de la **IZQUIERDA**.

SPAIN.

Advice on product care

To clean the surface use a soap and water solution.

Never use for any reason cleaning solutions containing abrasive substances, chloric acids, ammonia, vinegar, bleach, domestic acids, disinfectants, or anytype of abrasive pad.

WARNING! Incorrect cleaning may permanently ruin the surface of the products and in such case the manufacturer may not be held liable for damage.

The Manufacturer reserves the right to modify product and accessories at any time without prior notice. Datas, products and sketches included in this document are just for information and do not bind the producer.

ENGLAND.

Consejos para el cuidado del producto

La limpieza de las superficies se hace utilizando un jabón líquido diluido en agua.

No usar en ningún caso detergentes líquidos que contengan sustancias abrasivas ó a base de ácido clorhídrico, estropajos abrasivos, amoniaco, acetona, lejía, ácidos de uso doméstico, desinfectantes varios.

ATENCIÓN! El uso de productos desaconsejados puede danar irremediabilmente las superficies de los elementos, de lo cual el fabricante no se hará responsable en ningún caso.

La sociedad se reserva el derecho de modificar sus productos y accesorios en cualquier momento y sin previo aviso.

SPAIN.

ABOUTWATER



Disegni e grafica: www.dipi-designs.com 112700021000000U Rev.0