

A

B

C

D

6

6

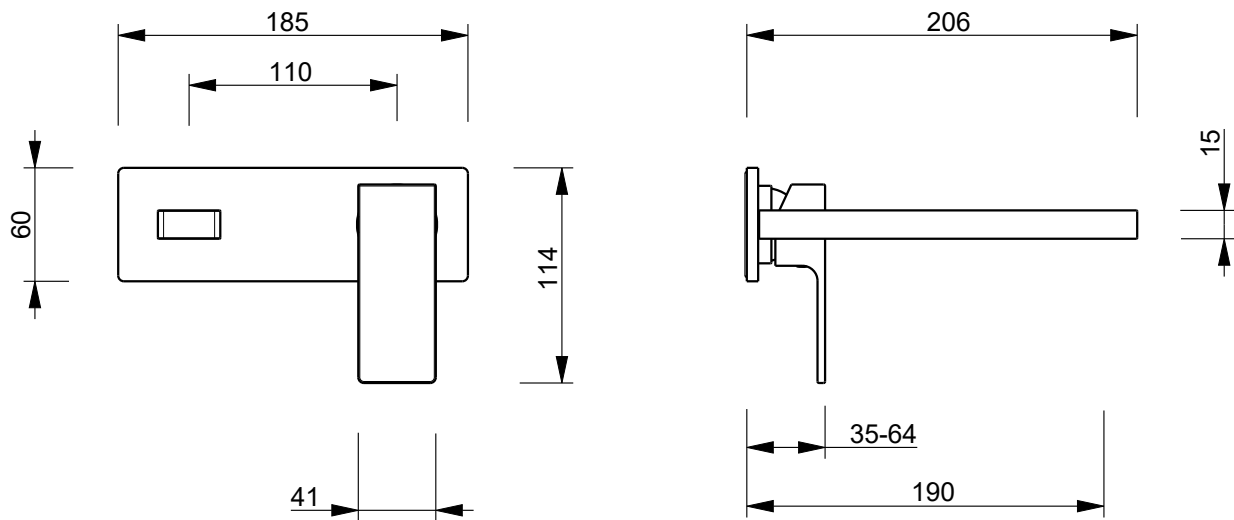

5

5

4

4

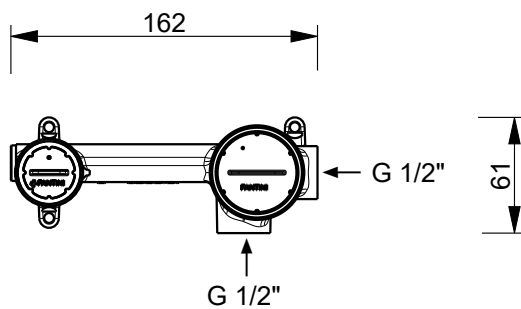

3

3

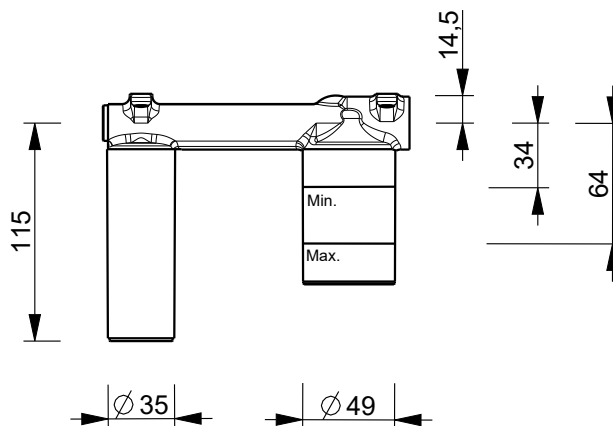

2

1

Art.: F613B+M111A

Serie: MINT



Desc.: IT GRUPPO LAVABO DA PARETE
 EN WALL MOUNT WASHBASIN MIXER
 DE WANDWASCHTISCHMISHER
 FR MITIGEUR LAVABO MURAL
 ES BATERIA LAVABO A PARED

Data: 12-Nov-25

Rev.: 0

Questo disegno e' di proprieta' della FANTINI S.p.A. Pertanto non potra' essere utilizzato e/o comunicato a terzi, anche in forma parziale, senza preventiva autorizzazione.
 This drawing is intellectual of FANTINI S.p.A. No use or disclosure, either fully or partially, to third parties is allowed without prior consent of the company.

A

B

C

D