

A

B

C

D

6

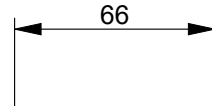
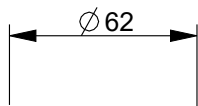

6

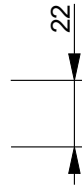
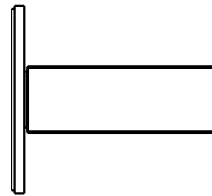
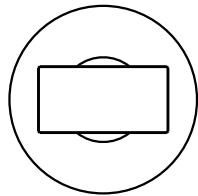

5

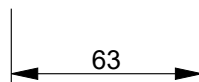
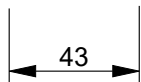

5

4

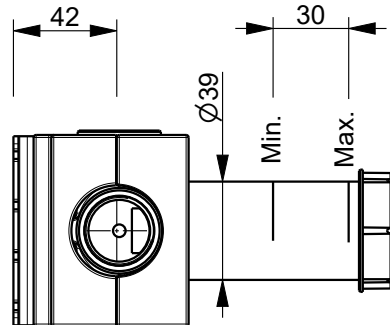
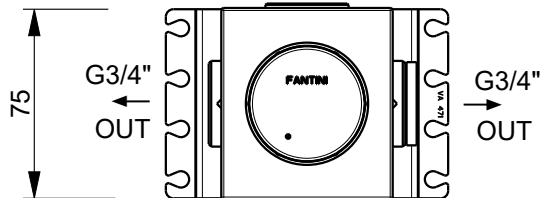
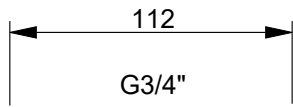

4

3

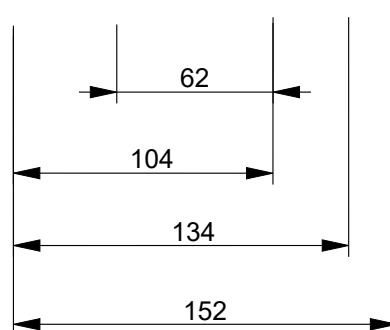

3

2

1

Art.: N291SB+D491A

Serie: VENEZIA



Desc.: IT RUBINETTO D'ARRESTO 3/4"
 EN BUILT-IN STOP VALVE
 DE 3/4" ABSPERVENTIL
 FR ROBINET D'ARRET A ENCASTRE
 ES LAVABE DE PASO 3/4" EMPOTRAR 3/4"

Data: 20-Jan-26

Rev.: 1

Questo disegno e' di proprieta' della FANTINI S.p.A. Pertanto non potra' essere utilizzato e/o comunicato a terzi, anche in forma parziale, senza preventiva autorizzazione.
 This drawing is intellectual of FANTINI S.p.A. No use or disclosure, either fully or partially, to third parties is allowed without prior consent of the company.

A

B

C

D