

A

B

C

D

6

6

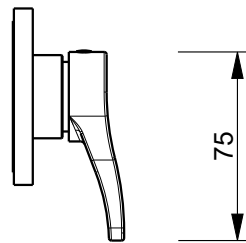
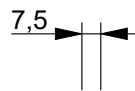
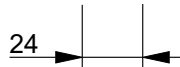
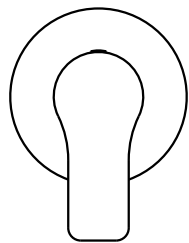
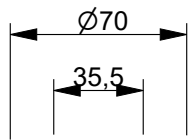

5

5

4

4

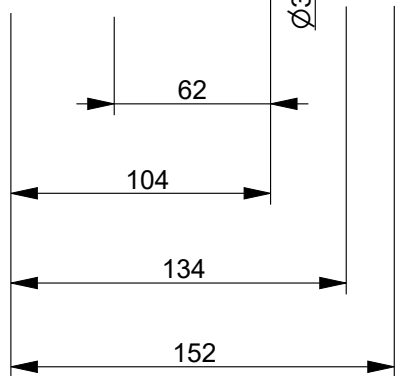
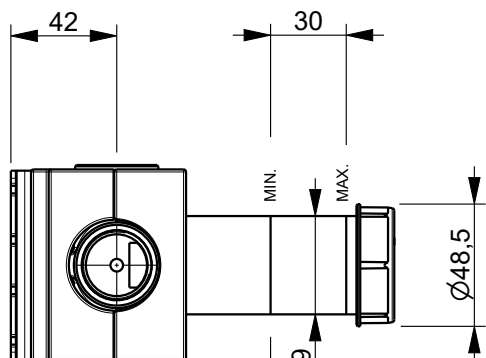
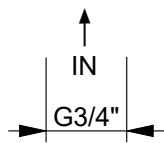
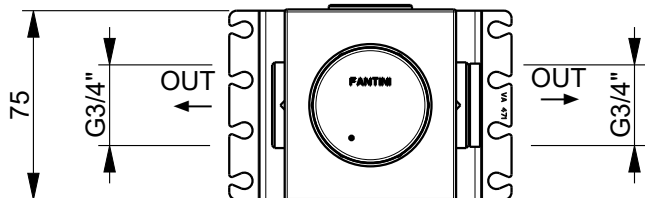
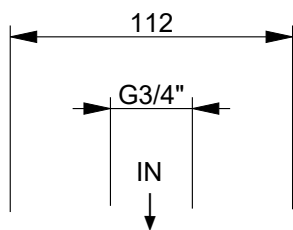

3

3

2

1

Art.: B490B+D491A

Serie: LISSONI



Desc.: IT RUBINETTO D'ARRESTO 3/4"
 EN BUILT-IN 3/4" STOP-VALVE
 DE ABSPERVENTL 3/4"
 FR ROBINET D'ARRET A ENCASTER 3/4"
 ES LAVABE DE PASO EMPOTRAR 3/4"

Data: 10-Feb-26

Rev.: 1

Questo disegno e' di proprieta' della FANTINI S.p.A. Pertanto non potra' essere utilizzato e/o comunicato a terzi, anche in forma parziale, senza preventiva autorizzazione.
 This drawing is intellectual of FANTINI S.p.A. No use or disclosure, either fully or partially, to third parties is allowed without prior consent of the company.

A

B

C

D