

ART. P113B+M111A

Monomando lavabo a pared

- distancia a chorro 20 cm
- maneta
- limitador de caudal 5 l/m a 3 bar
- entradas de 1/2"
- SIN DESAGÜE

Fecha

Proyecto/Comentarios

Parte externa

- | | |
|---|-------------|
| <input type="checkbox"/> Matt Gun Metal PVD | 47 P5 P113B |
| <input type="checkbox"/> Pure Brass PVD | 47 Q7 P113B |
| <input type="checkbox"/> Raw Metal PVD | 47 Q8 P113B |

Parte empotrable

- | | |
|--------------------------|-------------|
| <input type="checkbox"/> | 44 00 M111A |
|--------------------------|-------------|

PRECIO TOTAL

- | | |
|---|-------------|
| <input type="checkbox"/> Matt Gun Metal PVD | 47 P5 P113B |
| <input type="checkbox"/> Pure Brass PVD | 47 Q7 P113B |
| <input type="checkbox"/> Raw Metal PVD | 47 Q8 P113B |

ART. P113B+M111A
Monomando lavabo a pared

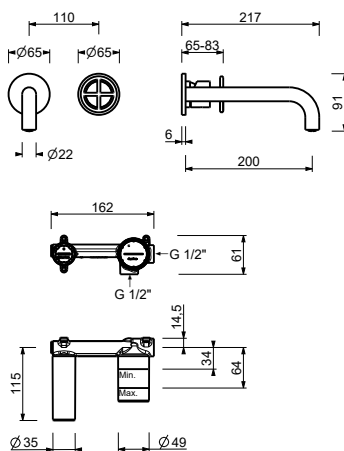

• **Integrated aerator**

Presión(bar)	Caudal (l/min)
0.5	2.32
1	3.1
2	4.1
3	5.1
4	5.54