



ART. M011B+M111A

墙出面盆龙头

- 龙头出水口长度19cm
- 开关手柄
- 流速限制器 5升/分钟 3 bar
- 1/2" 寸入水管
- 不带排水塞

日期 _____

项目/备注 _____

外部组件

- | | |
|--|-------------|
| <input type="checkbox"/> 铬色 | 24 02 M011B |
| <input type="checkbox"/> 哑光黑 | 24 13 M011B |
| <input type="checkbox"/> Matt Gun Metal PVD | 24 P5 M011B |
| <input type="checkbox"/> Matt British Gold PVD | 24 P6 M011B |
| <input type="checkbox"/> Matt Copper PVD | 24 P9 M011B |
| <input type="checkbox"/> Deep Black PVD | 24 S1 M011B |

总价

- | | |
|--|-------------|
| <input type="checkbox"/> 铬色 | 24 02 M011B |
| <input type="checkbox"/> 哑光黑 | 24 13 M011B |
| <input type="checkbox"/> Matt Gun Metal PVD | 24 P5 M011B |
| <input type="checkbox"/> Matt British Gold PVD | 24 P6 M011B |
| <input type="checkbox"/> Matt Copper PVD | 24 P9 M011B |
| <input type="checkbox"/> Deep Black PVD | 24 S1 M011B |

墙内预埋组件

- | | |
|--------------------------|-------------|
| <input type="checkbox"/> | 44 00 M111A |
|--------------------------|-------------|

LAME系列

ART. M011B+M111A 墙出面盆龙头

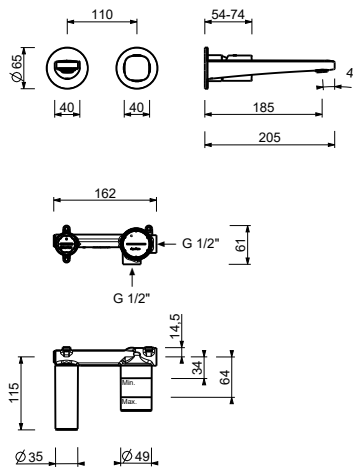

• Integrated aerator

压力 (巴)	水流速度 (升/分钟)
0.5	2.32
1	3.1
2	4.1
3	5.1
4	5.54