

ART. E014B+M111A

Mitigeur lavabo mural

- entraxe bec 25 cm
- manette CYLINDRIQUE avec TIGE
- avec plaque
- limiteur de débit 5 l/min à 3 bar
- entrées en 1/2"
- SANS VIDAGE

Date _____

Projet/Commentaire _____

Partie externe

- | | |
|--|-------------|
| <input type="checkbox"/> Chromé | 50 02 E014B |
| <input type="checkbox"/> Noir Mat | 50 13 E014B |
| <input type="checkbox"/> Blanc Mat | 50 29 E014B |
| <input type="checkbox"/> Matt Gun Metal PVD | 50 P5 E014B |
| <input type="checkbox"/> Matt British Gold PVD | 50 P6 E014B |
| <input type="checkbox"/> Matt Copper PVD | 50 P9 E014B |
| <input type="checkbox"/> Deep Black PVD | 50 S1 E014B |
| <input type="checkbox"/> Mokka PVD | 50 S5 E014B |
| <input type="checkbox"/> Pure Brass PVD | 50 Q7 E014B |
| <input type="checkbox"/> Raw Metal PVD | 50 Q8 E014B |
| <input type="checkbox"/> Acier Brossé | 50 93 E014B |

PRIX TOTAL

- | | |
|--|-------------|
| <input type="checkbox"/> Chromé | 50 02 E014B |
| <input type="checkbox"/> Noir Mat | 50 13 E014B |
| <input type="checkbox"/> Blanc Mat | 50 29 E014B |
| <input type="checkbox"/> Matt Gun Metal PVD | 50 P5 E014B |
| <input type="checkbox"/> Matt British Gold PVD | 50 P6 E014B |
| <input type="checkbox"/> Matt Copper PVD | 50 P9 E014B |
| <input type="checkbox"/> Deep Black PVD | 50 S1 E014B |
| <input type="checkbox"/> Mokka PVD | 50 S5 E014B |
| <input type="checkbox"/> Pure Brass PVD | 50 Q7 E014B |
| <input type="checkbox"/> Raw Metal PVD | 50 Q8 E014B |
| <input type="checkbox"/> Acier Brossé | 50 93 E014B |

Piece Partie à encastrer

- | | |
|--------------------------|-------------|
| <input type="checkbox"/> | 44 00 M111A |
|--------------------------|-------------|

ART. E014B+M111A
Mitigeur lavabo mural

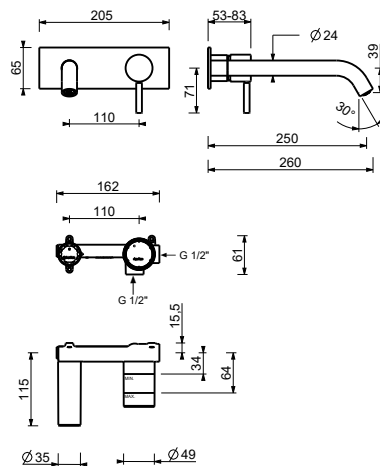

• **Integrated aerator**

Pression(bar)	Débit (l/min)
0.5	2.32
1	3.1
2	4.1
3	5.1
4	5.54