



ART. E014B+M111A

Wandwaschtischmischer

- Achsabstand Auslauf 25 cm
- ZYLINDRISCHER Griff mit HEBEL
- mit Abdeckplatte
- Wasserdurchflussbegrenzer auf 5 l/min bei 3 bar
- 1/2" Eingänge
- OHNE ABLAUF

Datum

Project/Kommentar

AP-Teil

- | | |
|---|-------------|
| <input type="checkbox"/> Chrom | 50 02 E014B |
| <input type="checkbox"/> Schwarz matt | 50 13 E014B |
| <input type="checkbox"/> Weiß matt | 50 29 E014B |
| <input type="checkbox"/> Matt Gun Metal PVD | 50 P5 E014B |
| <input type="checkbox"/> Matt British Gold PVD | 50 P6 E014B |
| <input type="checkbox"/> Matt Copper PVD | 50 P9 E014B |
| <input type="checkbox"/> Deep Black PVD | 50 S1 E014B |
| <input type="checkbox"/> Mokka PVD | 50 S5 E014B |
| <input type="checkbox"/> Pure Brass PVD | 50 Q7 E014B |
| <input type="checkbox"/> Raw Metal PVD | 50 Q8 E014B |
| <input type="checkbox"/> Edelstahl gebürstet | 50 93 E014B |

GESAMTPREIS

- | | |
|--|-------------|
| <input type="checkbox"/> Chrom | 50 02 E014B |
| <input type="checkbox"/> Schwarz matt | 50 13 E014B |
| <input type="checkbox"/> Weiß matt | 50 29 E014B |
| <input type="checkbox"/> Matt Gun Metal PVD | 50 P5 E014B |
| <input type="checkbox"/> Matt British Gold PVD | 50 P6 E014B |
| <input type="checkbox"/> Matt Copper PVD | 50 P9 E014B |
| <input type="checkbox"/> Deep Black PVD | 50 S1 E014B |
| <input type="checkbox"/> Mokka PVD | 50 S5 E014B |
| <input type="checkbox"/> Pure Brass PVD | 50 Q7 E014B |
| <input type="checkbox"/> Raw Metal PVD | 50 Q8 E014B |
| <input type="checkbox"/> Edelstahl gebürstet | 50 93 E014B |

UP-Teil

- | | |
|--------------------------|-------------|
| <input type="checkbox"/> | 44 00 M111A |
|--------------------------|-------------|

ART. E014B+M111A
Wandwaschtismischer

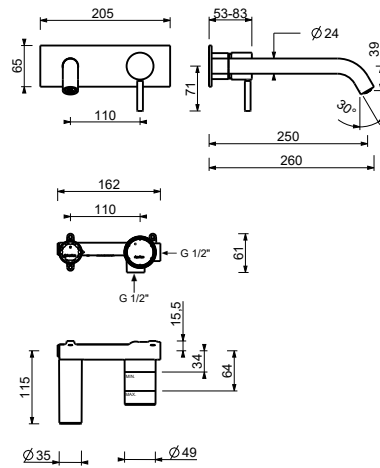

• **Integrated aerator**

Wasserdruck(bar)	Durchfluss (l/min)
0.5	2.32
1	3.1
2	4.1
3	5.1
4	5.54