



ART. E812B+M111A

Monomando lavabo a pared

- distancia a chorro 25 cm
- maneta CILÍNDRICA con LEVA
- con embellecedores
- limitador de caudal 5 l/m a 3 bar
- entradas de 1/2"
- SIN DESAGÜE

Fecha

Proyecto/Comentarios

Parte externa

- | | | |
|--------------------------|------------------------|-------------|
| <input type="checkbox"/> | Cromo | 50 02 E812B |
| <input type="checkbox"/> | Negro Opaco | 50 13 E812B |
| <input type="checkbox"/> | Blanco Opaco | 50 29 E812B |
| <input type="checkbox"/> | Matt Gun Metal PVD | 50 P5 E812B |
| <input type="checkbox"/> | Matt British Gold PVD | 50 P6 E812B |
| <input type="checkbox"/> | Matt Copper PVD | 50 P9 E812B |
| <input type="checkbox"/> | Deep Black PVD | 50 S1 E812B |
| <input type="checkbox"/> | Mokka PVD | 50 S5 E812B |
| <input type="checkbox"/> | Pure Brass PVD | 50 Q7 E812B |
| <input type="checkbox"/> | Raw Metal PVD | 50 Q8 E812B |
| <input type="checkbox"/> | Acero Cepillado | 50 93 E812B |

Parte empotrable

- | | | |
|--------------------------|--|-------------|
| <input type="checkbox"/> | | 44 00 M111A |
|--------------------------|--|-------------|

PRECIO TOTAL

- | | | |
|--------------------------|-----------------------|-------------|
| <input type="checkbox"/> | Cromo | 50 02 E812B |
| <input type="checkbox"/> | Negro Opaco | 50 13 E812B |
| <input type="checkbox"/> | Blanco Opaco | 50 29 E812B |
| <input type="checkbox"/> | Matt Gun Metal PVD | 50 P5 E812B |
| <input type="checkbox"/> | Matt British Gold PVD | 50 P6 E812B |
| <input type="checkbox"/> | Matt Copper PVD | 50 P9 E812B |
| <input type="checkbox"/> | Deep Black PVD | 50 S1 E812B |
| <input type="checkbox"/> | Mokka PVD | 50 S5 E812B |
| <input type="checkbox"/> | Pure Brass PVD | 50 Q7 E812B |
| <input type="checkbox"/> | Raw Metal PVD | 50 Q8 E812B |
| <input type="checkbox"/> | Acero Cepillado | 50 93 E812B |

ART. E812B+M111A
Monomando lavabo a pared

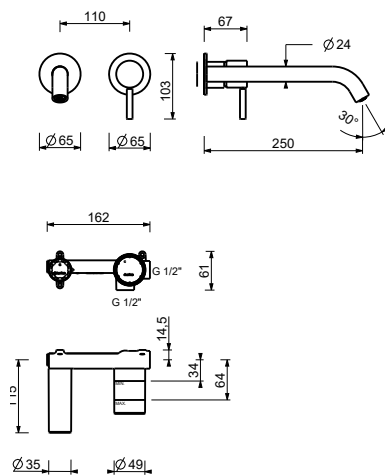

• **Integrated aerator**

Presión(bar)	Caudal (l/min)
0.5	2.32
1	3.1
2	4.1
3	5.1
4	5.54