

ART. V611B+M111A

Monomando lavabo a pared

- distancia a chorro 20 cm
- maneta
- limitador de caudal 5 l/m a 3 bar
- entradas de 1/2"
- SIN DESAGÜE

Fecha

Proyecto/Comentarios

Parte externa

- | | |
|--|-------------|
| <input type="checkbox"/> Cromo | 61 02 V611B |
| <input type="checkbox"/> Negro Opaco | 61 13 V611B |
| <input type="checkbox"/> Matt Gun Metal PVD | 61 P5 V611B |
| <input type="checkbox"/> Matt British Gold PVD | 61 P6 V611B |
| <input type="checkbox"/> Deep Black PVD | 61 S1 V611B |

PRECIO TOTAL

- | | |
|--|-------------|
| <input type="checkbox"/> Cromo | 61 02 V611B |
| <input type="checkbox"/> Negro Opaco | 61 13 V611B |
| <input type="checkbox"/> Matt Gun Metal PVD | 61 P5 V611B |
| <input type="checkbox"/> Matt British Gold PVD | 61 P6 V611B |
| <input type="checkbox"/> Deep Black PVD | 61 S1 V611B |

Parte empotrable

- | | |
|--------------------------|-------------|
| <input type="checkbox"/> | 44 00 M111A |
|--------------------------|-------------|

MYO

ART. V611B+M111A Monomando lavabo a pared

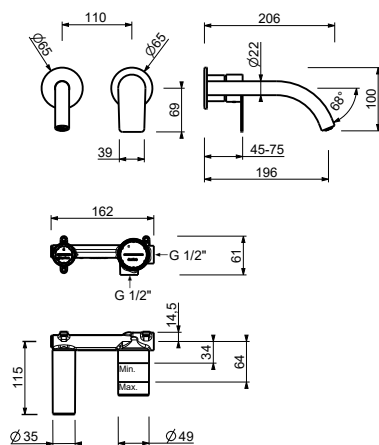

• Integrated aerator

Presión(bar)	Caudal (l/min)
0.5	2.32
1	3.1
2	4.1
3	5.1
4	5.54