

## **TANGRAM** carved wall tile

Tangram is the right triangle for your space. Tessellations of the wall tile offer endless possibilities—and address the acoustics of a space in a bold, graphic way. Made from sound-absorbing PET felt, the carved wall tile is available in TURF's 9 mm felt colors.



PATENT PENDING

# SPECS

## PRODUCT

Tangram carved wall tile

## CONTENT

polyester (PET) felt  
60% pre-consumer recycled

# 9MM TILE

## DIMENSIONS

11.75" W x 11.75" H x 9 mm T

## FELT THICKNESS

9 mm

## BEVELED EDGE

carved at a 45° angle  
4.5 mm from the bottom

FRONT VIEW

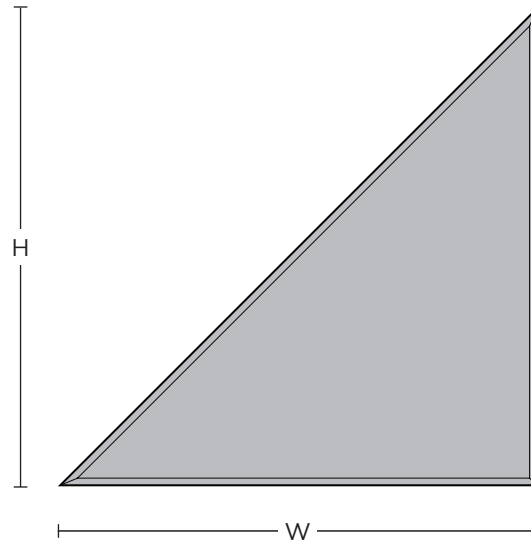

SIDE VIEW

enlarged edge

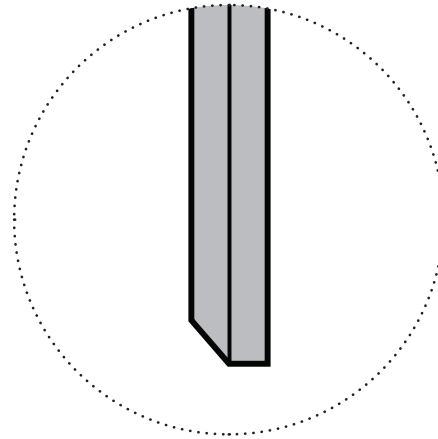

T

# LAYOUT

Tangram's triangular tiles may be configured in a variety of ways.

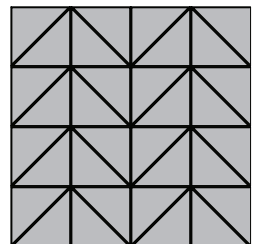
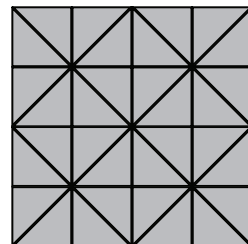
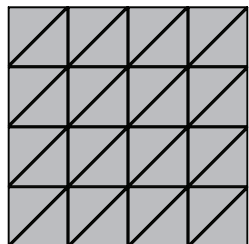

# 9MM FELT

TURF's Tangram carved wall tile is made with 9mm PET felt board.

The process used to create PET felt often results in a heathered effect where multiple tones are present. Slight variations in color should be expected when using this sustainable material.

Felt thickness is 9mm +/- 0.5 mm.

**Monitors and printers vary. Please request a material sample to verify felt colors.**

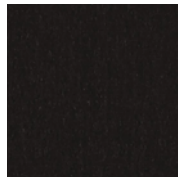

07 BLACK

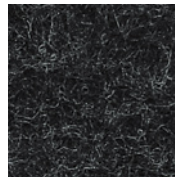

06 CHARCOAL

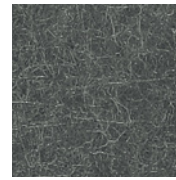

38 MATTE GREY

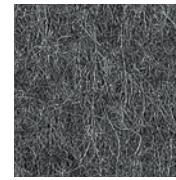

86 SLATE

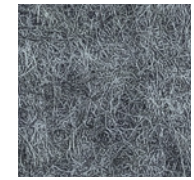

98 STORM



01 CREAM



50 IVORY



05 WHITE

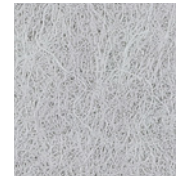

66 PEWTER

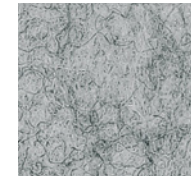

04 LIGHT GREY



78 WHEAT



82 BARLEY

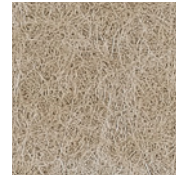

54 LATTE



48 LIGHT BROWN

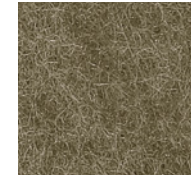

32 BROWN

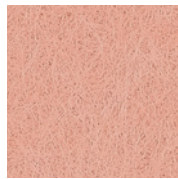

94 CORAL



42 ORANGE

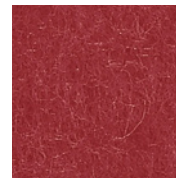

16 RED



58 RASPBERRY

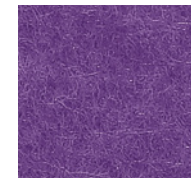

39 LAVENDER



20 MANGO



62 SUNFLOWER



45 YELLOW



47 LIME



14 GREEN

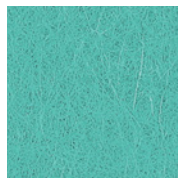

70 AQUA

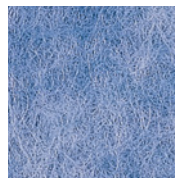

90 SKY

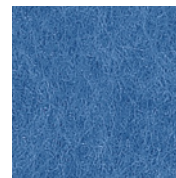

25 LIGHT BLUE

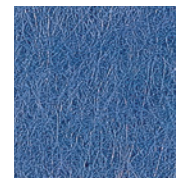

74 DENIM

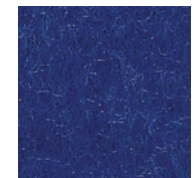

29 DARK BLUE



# TECH

## ACOUSTICS

ASTM C423-17: Type A Mounting

## FIRE RATING

ASTM E-84 - Class A

## VOC

ASTM D5116 Compliant



**TURF 9mm PET Acoustic Panel**  
Turf Design

Final Assembly: Elgin, Illinois, USA  
Life Expectancy: 50 Years  
End of Life Options: Salvageable/Reusable in its Entirety, Recyclable (100%)

Ingredients:  
Polyethylene Terephthalate; PET; Antioxidant 1076; Benzenamine, 4-(1-Methyl-1-Phenylethyl)-N-[4-(1-Methyl-1-Phenylethyl)Phenyl]-, Benzenepropanoic Acid, 3,5-Bis(1,1-Dimethylethyl)-4-Hydroxy-, Octadecyl Ester, Octadecanamide, N,N'-1,2-Ethanediybis-, Stearic Acid, Titanium Dioxide

Living Building Challenge Criteria:

TFD-0002	EXP 01 DEC 2020
VOC Content: N/A	VOC Emissions: CDPH Compliant
Declaration Status	<input checked="" type="checkbox"/> LBC Red List Free <input type="checkbox"/> LBC Compliant <input type="checkbox"/> Declared

MANUFACTURER RESPONSIBLE FOR LABEL ACCURACY  
INTERNATIONAL LIVING FUTURE INSTITUTE™ declareproducts.com

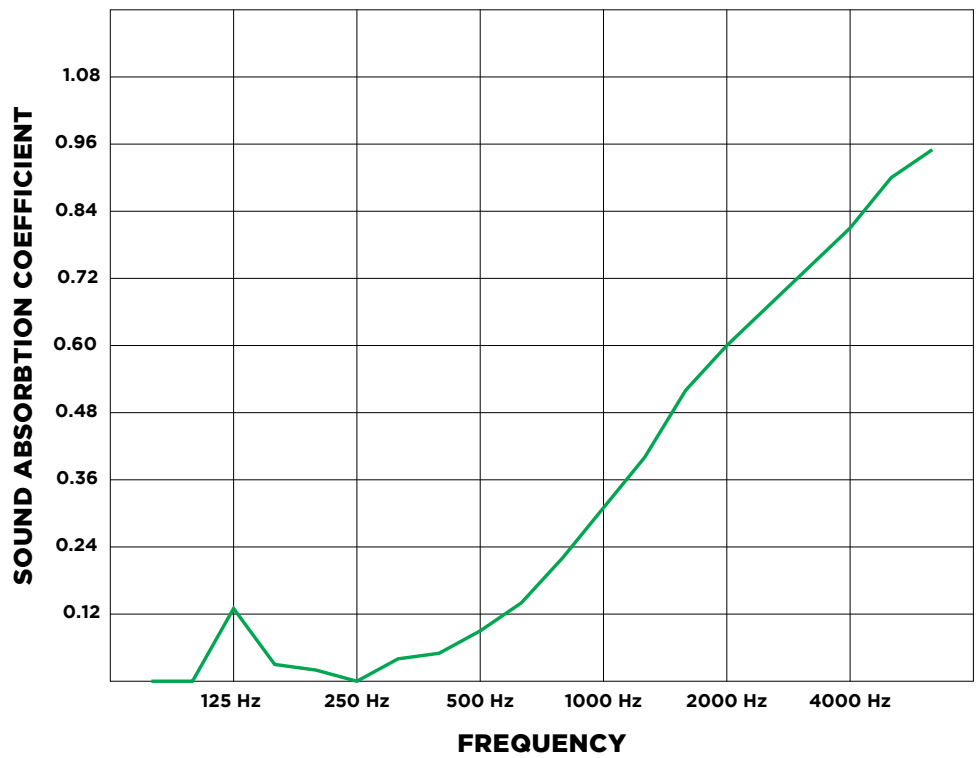

9MM TILE: NRC = 0.25

ASTM C423-17: Type A Mounting. Carved wall tile NRC varies depending on field conditions and arrangement. Contact TURF for testing details.

# DETAILS

## LEAD TIME

ships in four (4) weeks

## INSTALLATION

Tangram is available with or without an adhesive backing. More information is available in the carved wall tile installation instructions.

## WARRANTY

three (3) years

## MAINTENANCE

Vacuum occasionally to remove any particulate matter and air-borne debris or dust. Compressed air can be used to dust the material in difficult to reach areas for large assemblies. Use standard household cleaners for spot cleaning.

## CUSTOM

Tangram carved wall tiles may be customized with additional layers and colors. Contact your rep for details.

## ADHESIVE BACKING

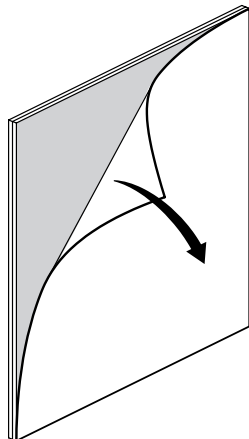

A manufacturer-applied adhesive backing is available. The pressure-activated backing instantly adheres to a variety of wall surfaces.

## CONSTRUCTION ADHESIVE

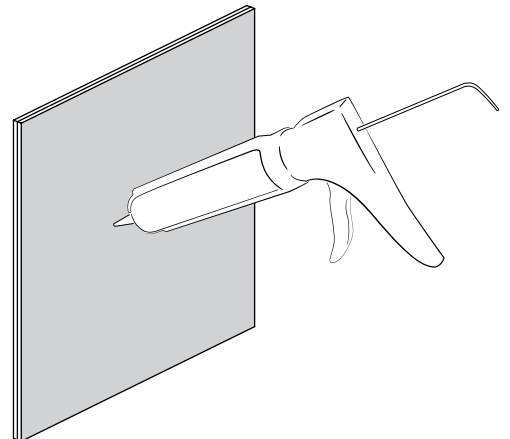

Carved wall tiles without an adhesive backing should be installed with a construction-grade adhesive specified by the contractor.

