

VALLOX X-Line PTXPA

Manual



The Vallox X-Line PTXPA control hood is suited to controlling AC roof fans and AC ventilation units.

The cooker hood is designed to be used above the cooker top, as a general extraction valve in the kitchen, and as a ventilation system control panel.

VENTILATION CONTROL

Apartment-specific ventilation units allow residents to adjust the ventilation efficiency. Ventilation is controlled based on the need e.g. through the cooker hood, ventilation control panel, or a separate control centre.

It is recommended that ventilation be left turned on during long holidays also. This keeps the indoor air fresh and prevents humidity from condensing in the ventilation ducts and structures. It also reduces the risk of moisture damage.

1. Away mode (position 1).

The ventilation efficiency can be temporarily reduced when the apartment is unoccupied.

2. Normal mode (position 2 or 3)

Ventilation must be continuous, i.e. the air inside the building must be replaced at least once every two hours.

3. Boost mode (positions 3-4)

Cooking, sauna, bathing, drying of clothes, excessive heat, and other similar situations can require that ventilation be increased from the standard setting. In such a situation, ventilation must be increased. This is done by boosting the ventilation either in general or space-specifically. For example, the damper of the cooker hood is kept open during cooking but is closed or in the minimum position at other times.

USING THE UNIT

Front panel

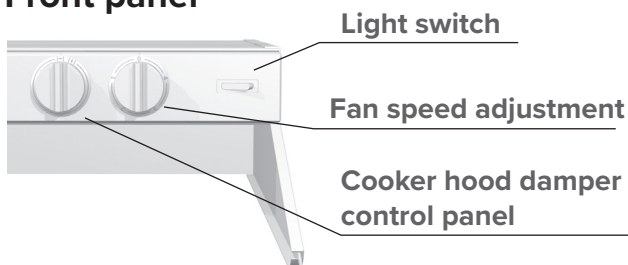

Cooker hood damper control panel

A rotary, automatically closing damper equipped with a timer. When turned to the right, the damper closes, switching on the timer which will automatically close the damper in 60 minutes.

When turned to the right, the damper is in the open position.

When turned to the left, the damper is in the closed position: In normal circumstances, the damper must be closed, which boosts the extract air flow from other premises.

Damper open

- when the cooker top or the oven is used for cooking or
- when the load in the kitchen is exceptional e.g. due to the use of strong detergents or the presence of a large number of people.



WARNING

If the ventilation of the apartment is turned off, the entry of fresh replacement air into the apartment and the extraction of used air from the apartment are prevented. Impurities, such as carbon dioxide, humidity, smells, formaldehyde, dust, and radon, which come from people, structures, and the soil will quickly contaminate the room air and are harmful to the health of people. Excessive humidity may damage the structures of the building and result in mould and fungal growth. For this reason, building regulations require that ventilation be turned on at all times and that its efficiency is adjusted based on the needs of the user.



CAUTION

- Neglecting the cleaning of the grease filter can cause a fire hazard.
- The outer surfaces of the hood can become hot when the cooker or the oven is turned on.
- Flaming is forbidden underneath the cooker hood.
- Always follow the instructions provided on adjusting the efficiency of ventilation.
- Enable a sufficient supply air flow into the room if the cooker hood and non-electric devices are used simultaneously.

Cooker hood light switch

Rocker switch operation.

- Right side down, light on
- Left side down, light off

Available settings for fan speed

1. Away mode
 2. Normal mode
 3. Boost mode
 4. Maximum boost mode
1. Cooking smell removal at minimum power
 2. Cooking smell removal at approximately 50% power
 3. Cooking smell removal at approximately 75% power
 4. Cooking smell removal at maximum power

MAINTENANCE

Keep the cooker hood clean. Wipe outer surfaces regularly with water containing a small amount of a mild detergent. Clean off any grease stains immediately. Do not use abrasive or corrosive detergents or tools.

Keep the grease filter clean to ensure an adequate extract air flow. The grease filter must be washed with warm water and detergent by hand or in a dishwasher at least 1-2 times a month.

Removing and mounting the grease filter

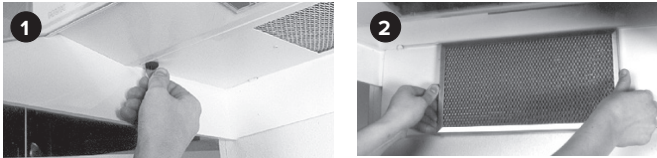

- Open the quick connectors of the bottom plate of the cooker hood by turning (Figure 1).
- Turn the bottom plate down.
- Remove the grease filter from its holder (Figure 2).

Replacing the lamp

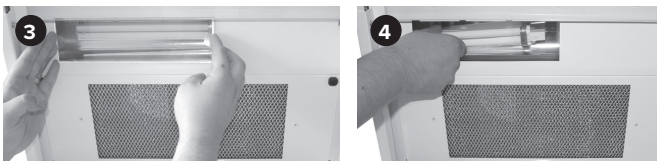

- Remove the protective glass of the lamp by moving it to the left (Figure 3).
- Remove the lamp by pulling it to the left (Figure 4).
- Lamp type: G23 LED.

INSTALLATION

Use the mounting accessories included in the package to fasten the cooker hood in place.

1. Shorten the extract air duct to be connected to the hood (125 mm spiral duct) to the correct length.
2. Where required, install a Vallox cover strip, for instance, (2142400 cover strip 500 or 2142500 cover strip 600) to cover the opening in the rear wall.
3. Lift the hood so that it is in contact with the duct.
4. Fasten the cooker hood with the mounting brackets or by other means, so that the hood is firmly in place and cannot move (figures 1, 2 and 3). The mounting screws included in the accessory bag are suited to walls made of wood, chipboard, cement or stone. Use appropriate mounting devices for other materials.
5. Check the tightness of the extract air duct system.
6. Plug the cooker hood into the mains. Ensure that the plug can be unplugged, where required.



WARNING

The unit is not intended for use by children under 8 or by persons with reduced sensory, physical or mental capabilities, or whose lack of knowledge and experience do not ensure safe operation of the unit. Such persons can use the unit under supervision, or by following the instructions of someone who is responsible for their safety. Do not let children play with the unit or to clean or maintain it without supervision.



CAUTION

- The cooker hood must not be connected to a flue that is used for removing combustion gases (e.g. from a wood- or gas-burning fireplace, cooker, or stove).
- The cooker hood must not be fastened through the side panels to the cabinets.
- Fans that are controlled through the cooker hood must have an engine cover and their maximum power must not exceed 340 W.
- Regulations on leading extraction air outdoors must be observed.



WARNING

A G23 PL lamp will cause damage!

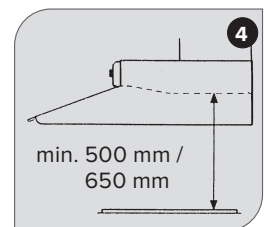

CAUTION

The minimum distance of the bottom edge of the grease filter to an electric cooker is 500 mm, and to a gas cooker 650 mm.

External electrical connection to the ventilation unit

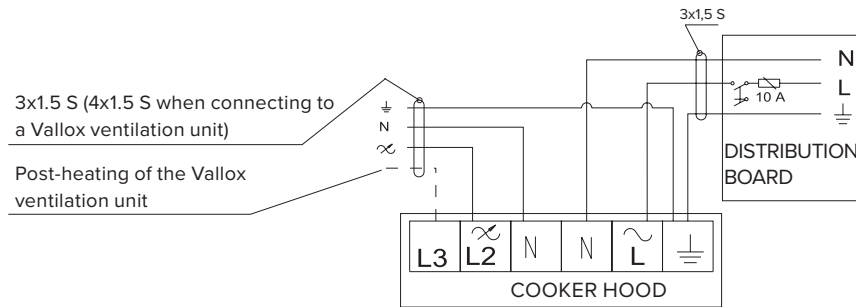

Electrical connections must be carried out by authorised persons only.

Measuring and adjusting the air flows

Standard ventilation

The volume flow rate of the air inside the cooker hood is measured with the damper closed and, where required, adjusted based on the static pressure loss and the performance scheme of the cooker hood.

- Measure the static pressure loss of the cooker hood by pushing the probe through the hole in the damper (see the figure).
- Determine the volume flow rate from the performance scheme based on the measured pressure and the number of open holes in the damper.

Adjustment:

- Cover the required number of holes in the damper with the magnetic strip that is delivered with the cooker hood.

Boost ventilation

The volume flow rate of the air inside the cooker hood is measured with the damper open based on the static pressure loss and the performance scheme of the cooker hood.

- Measure the static pressure loss of the cooker hood. The measuring point must be located 2 times the duct diameter above the outlet collar of the cooker hood (see figure).
- Determine the volume air flow based on the measured pressure and the performance scheme (with the damper open).

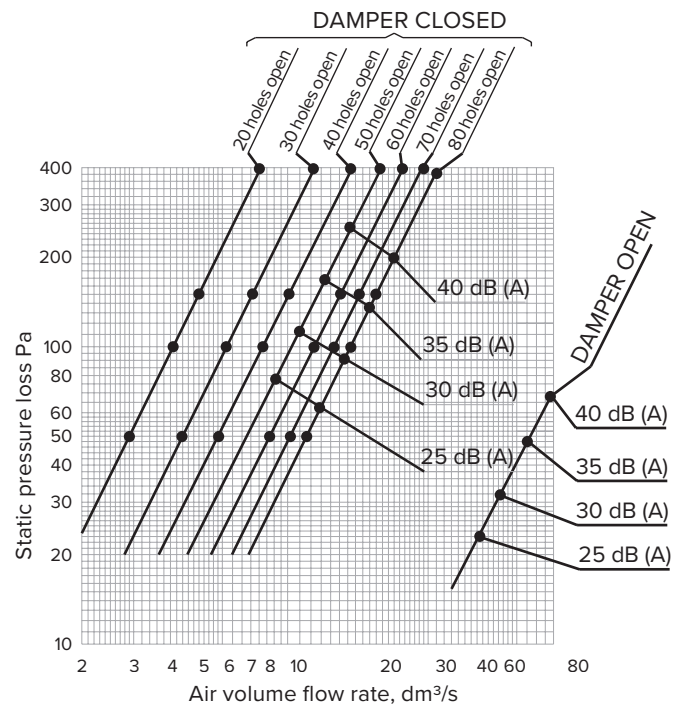
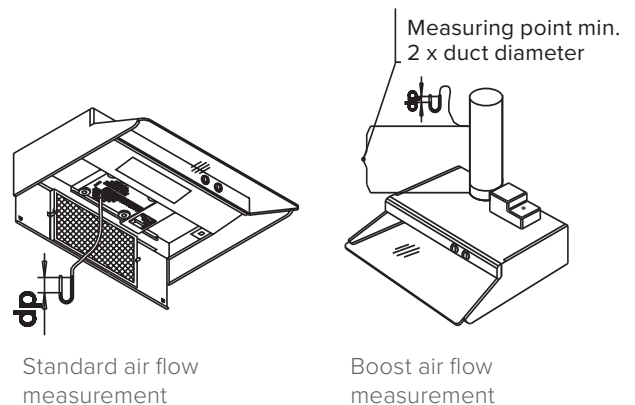

VALLOX

www.vallox.com

Vallox Oy | Myllykyläntie 9-11 | 32200 LOIMAA | FINLAND