

Unit Type:
Project Unit Type:
Project: VALLOX-SR1500_REV
Order Number:
Project Name
Manufacturing Date: 25.12.2025

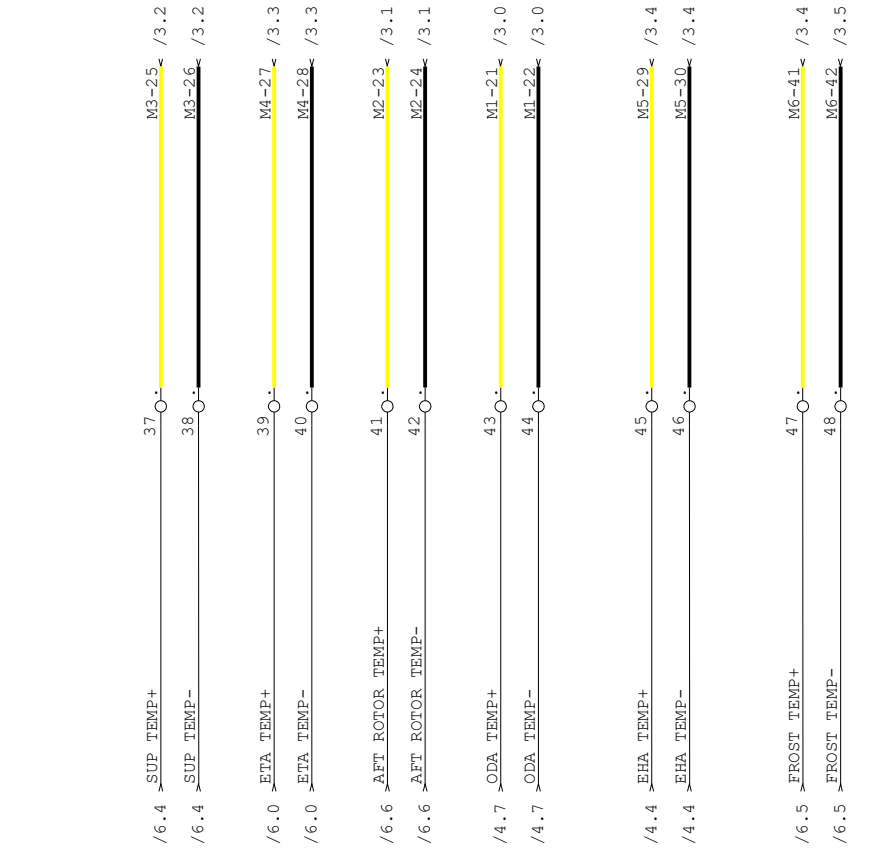

L1 /2.0
L2 /2.0
L3 /2.0
N /2.0
PE /2.0

Status	Rev.	Date	Name	Date	Drawn by	Checked by	Standard	Project Name		Sheet current	
										1 previous	
Section								Drawing number		next	
								Scale 1:1		2 Total number	
										6	

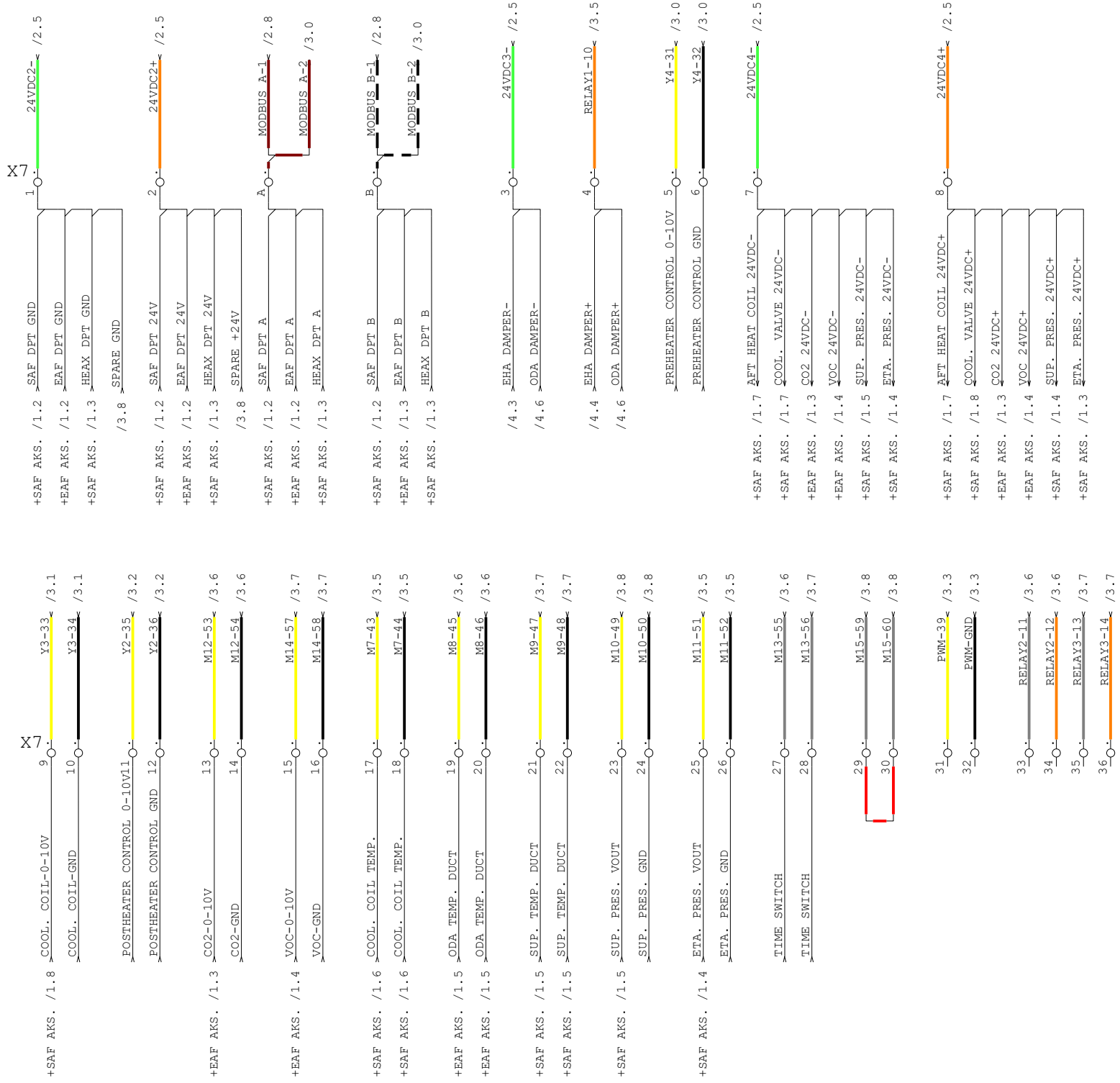
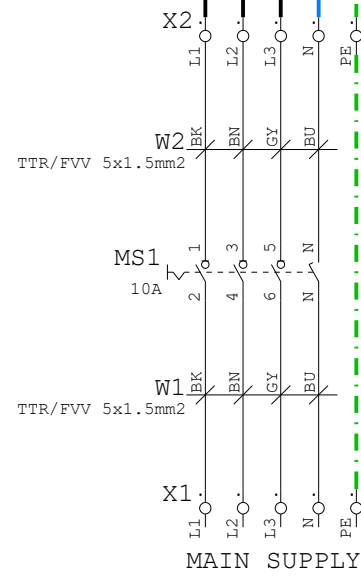
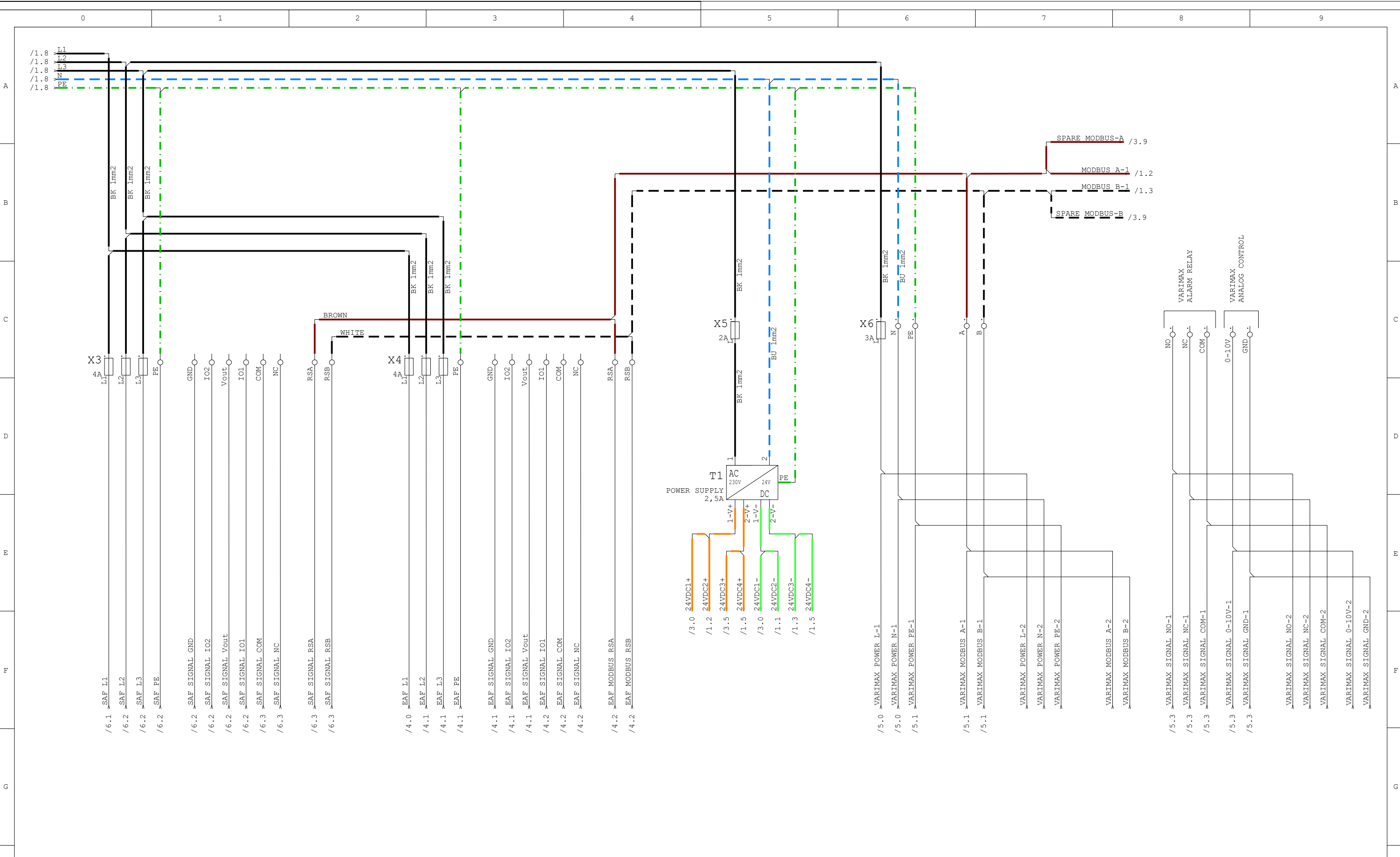

Status	Rev.	Date	Name	Date	Drawn by	Checked by	Standard	Project Name		Sheet	
										current	
										2	
										previous	
										1	
										next	
										3	
										Total	
										number	
										6	
Section								Drawing number		Scale	
										1:1	

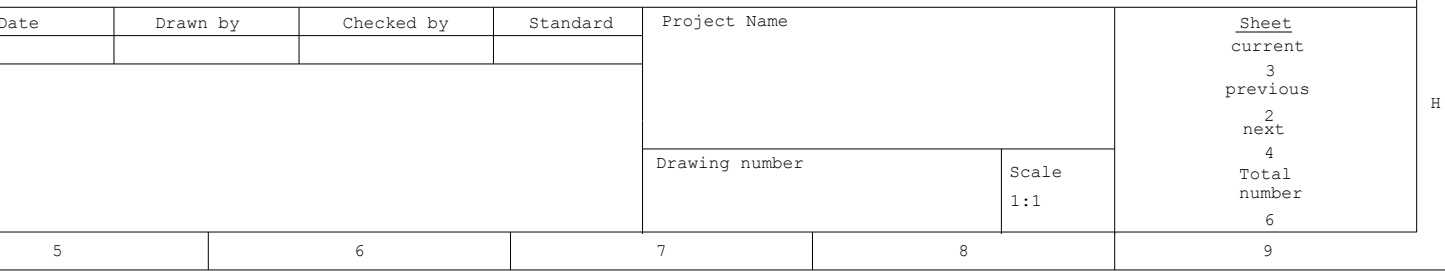
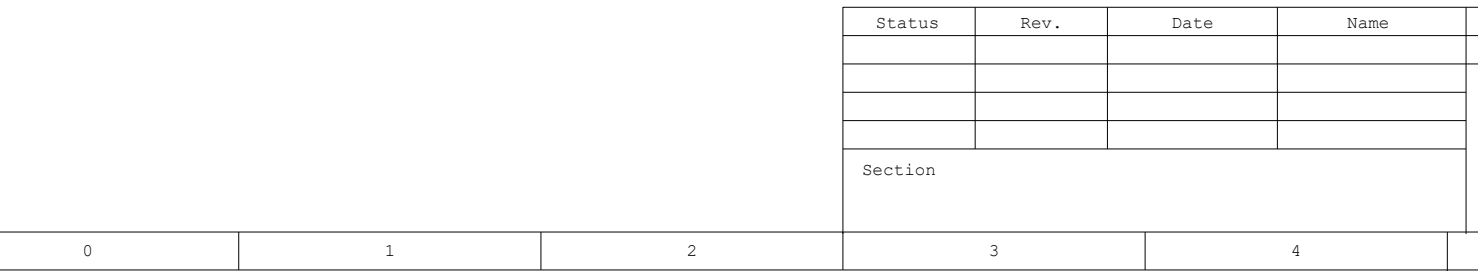
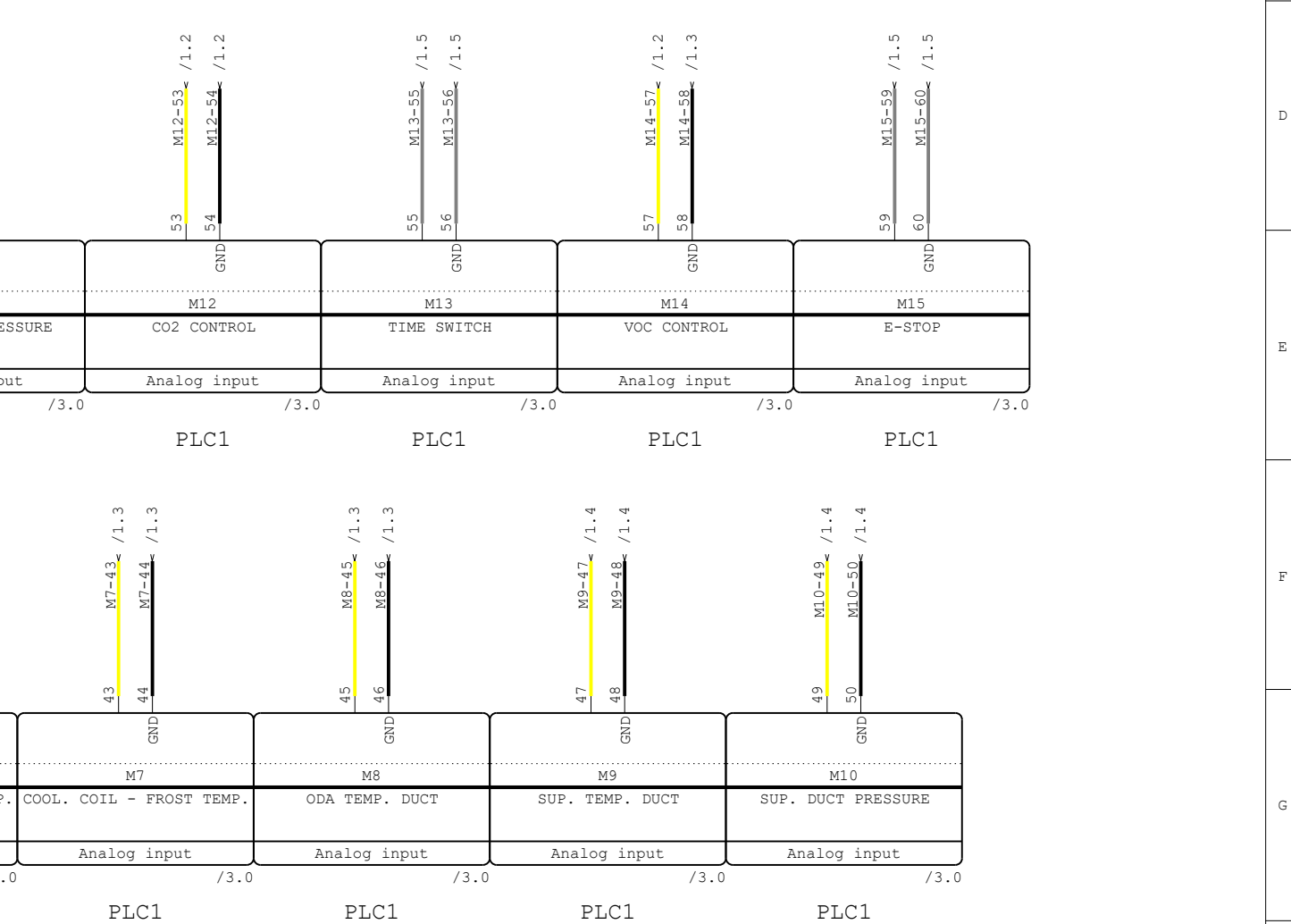
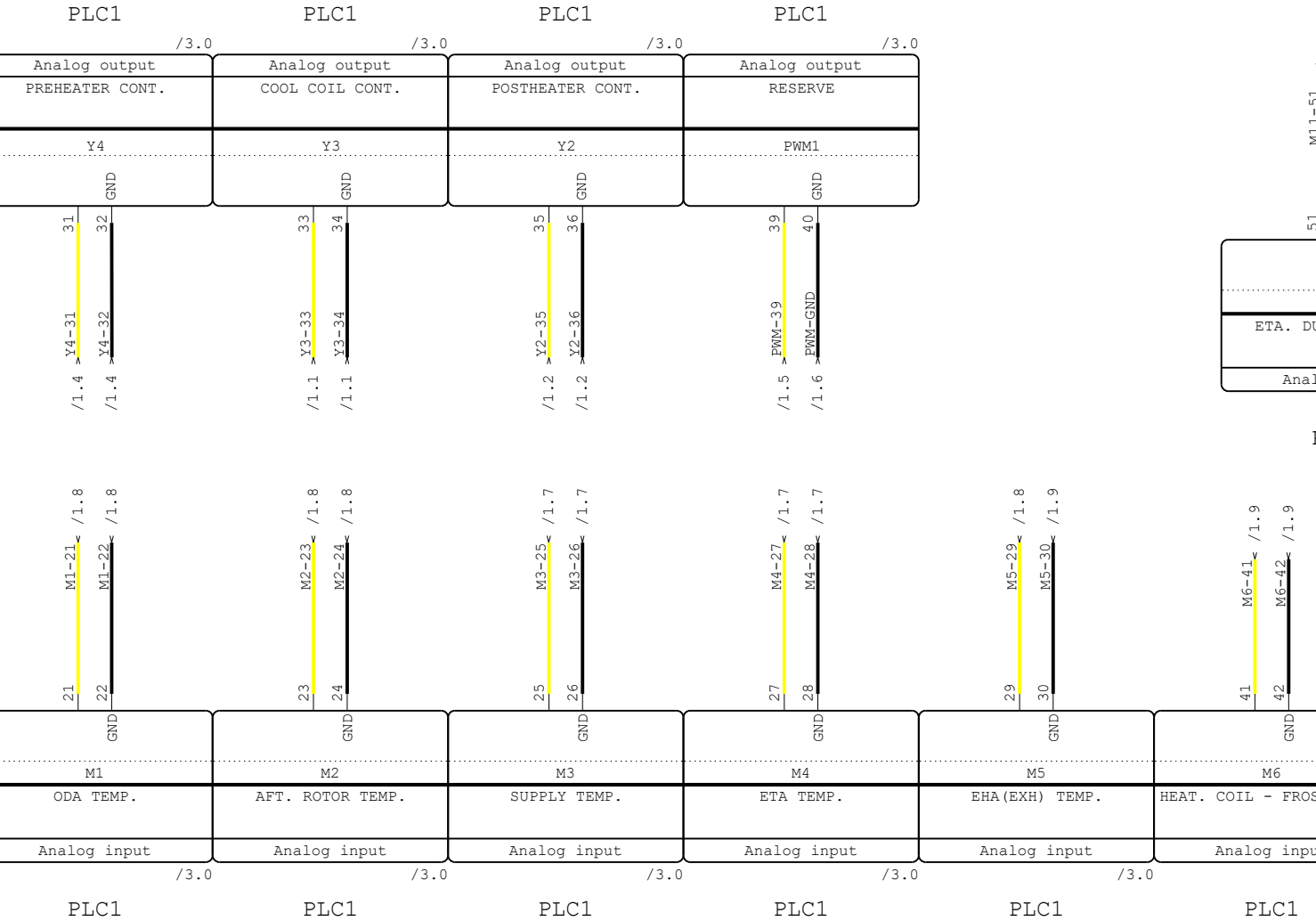
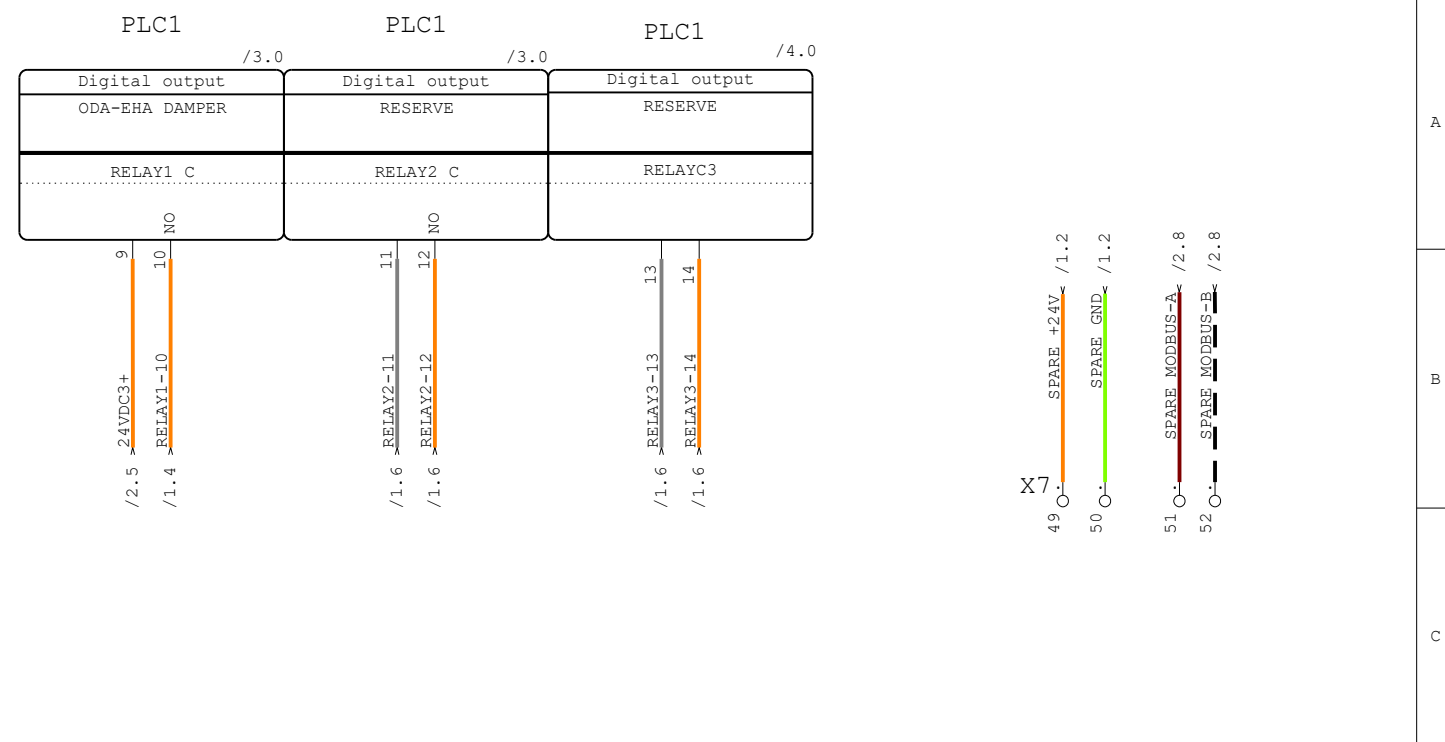
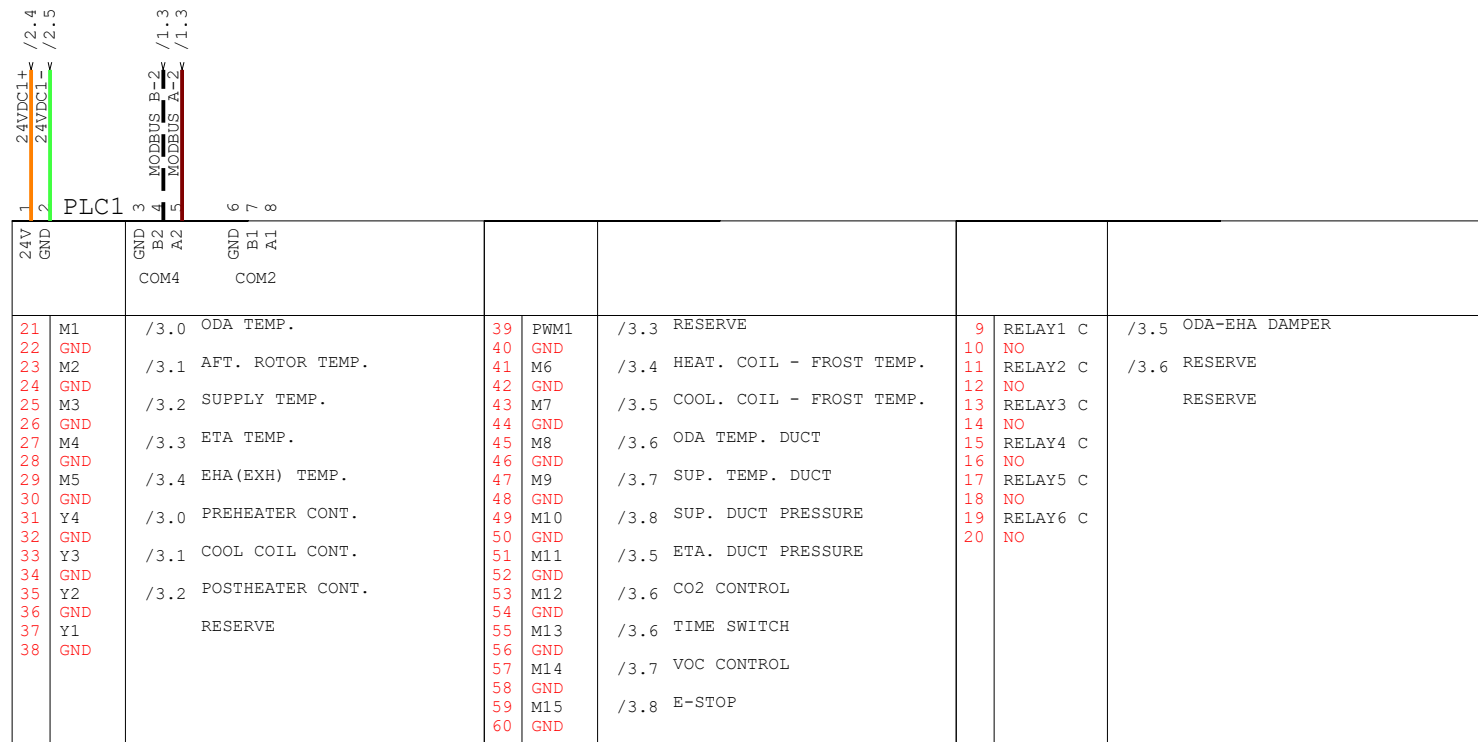

Status	Rev.	Date	Name	Date	Drawn by	Checked by	Standard	Project Name	Sheet current
									3
									previous
									2
									next
									4
									Total number
									6

Drawing number	Scale 1:1
----------------	-----------

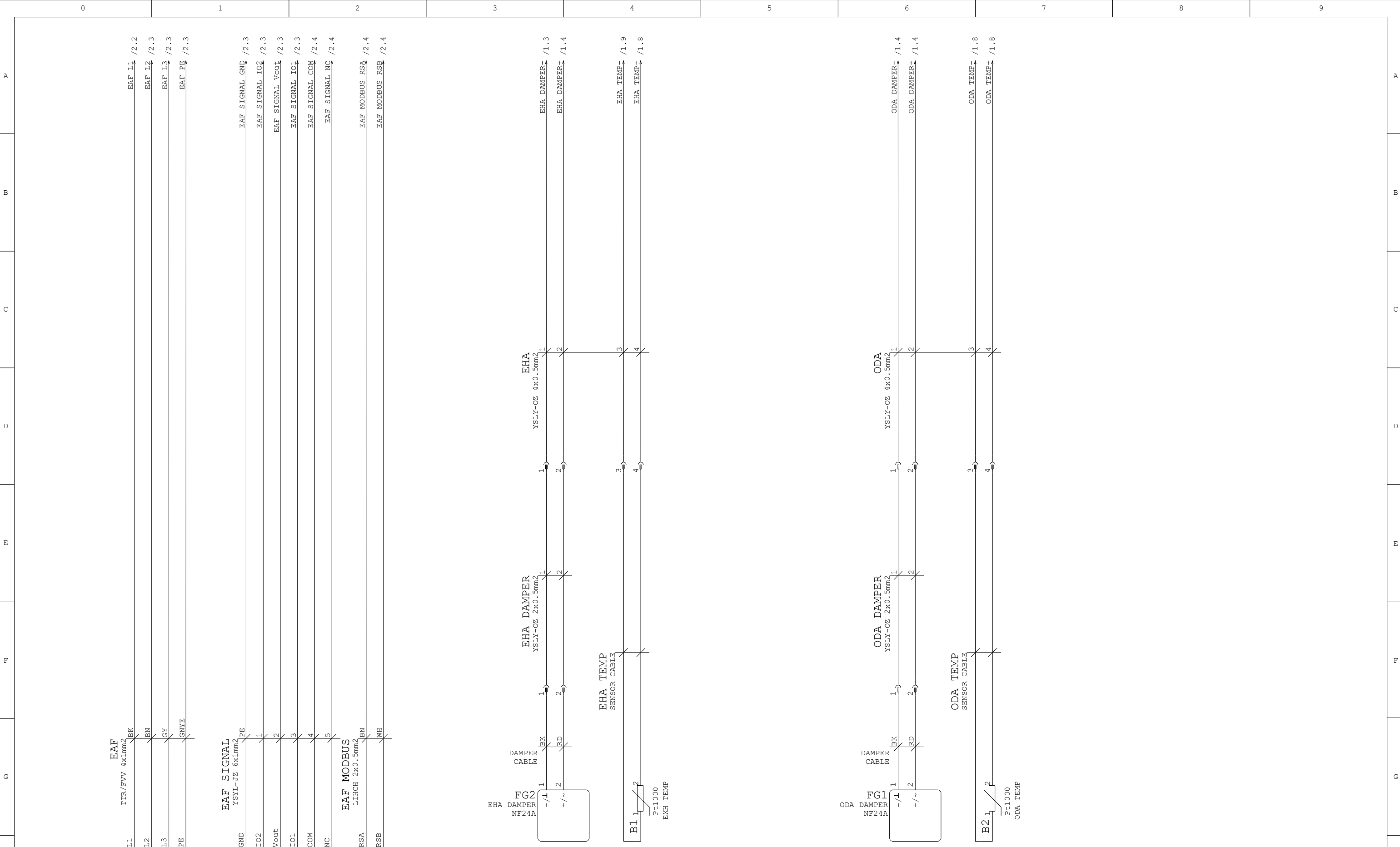

M2
 EXHAUST FAN-1
 EBM 8300100866
 8400102483
 1.5kW / 2.3A
 K FACTOR: 190
 V= 1500m3/h

Status	Rev.	Date	Name	Date	Drawn by	Checked by	Standard	Project Name		Sheet	
										current	4
										previous	3
										next	5
										Total	6
Section								Drawing number		Scale 1:1	

A
B
C
D
E
F
G
H

A
B
C
D
E
F
G
H

0 1 2 3 4 5 6 7 8 9

0 1 2 3 4 5 6 7 8 9

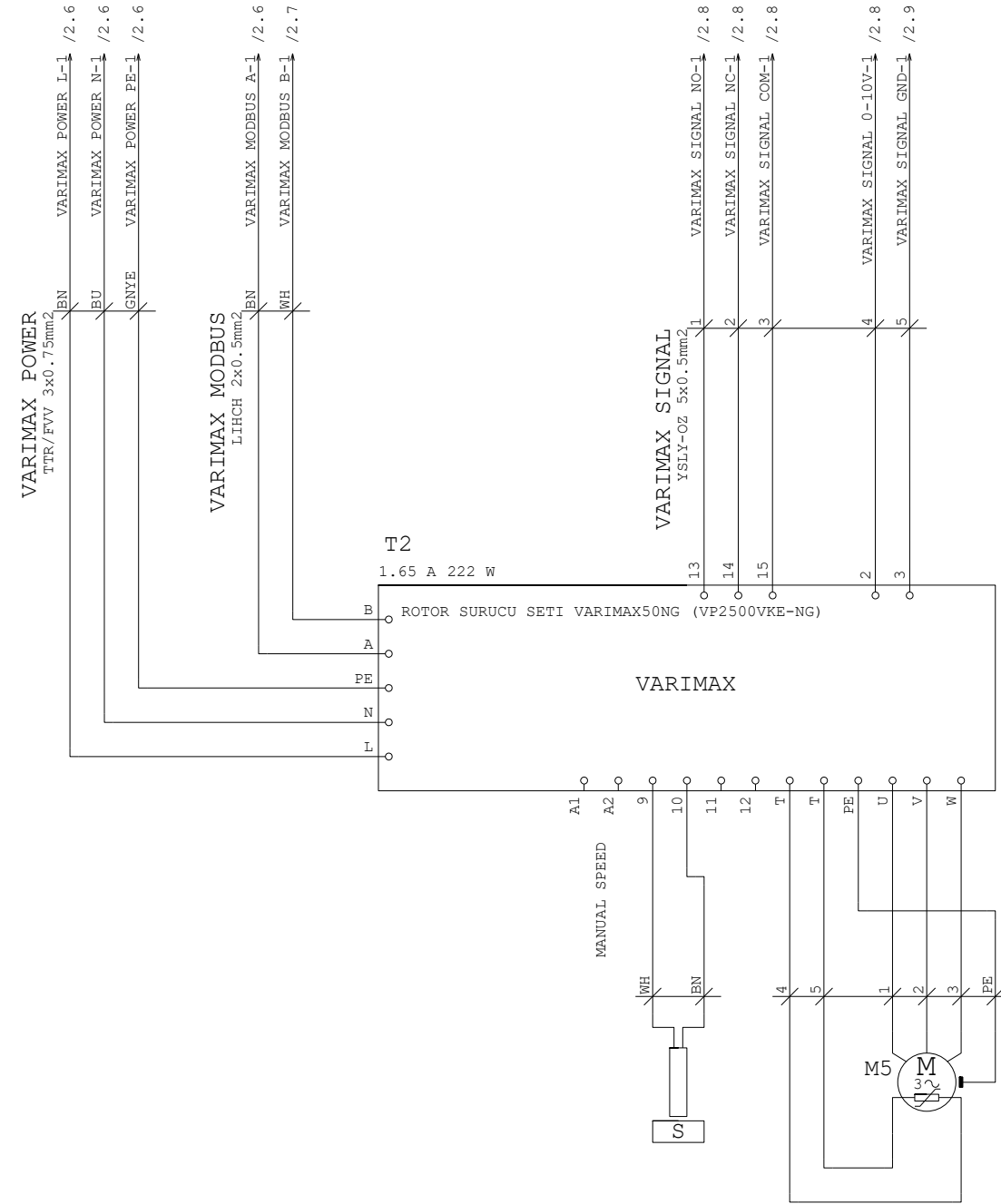

Status	Rev.	Date	Name	Date	Drawn by	Checked by	Standard	Project Name		Sheet current
										5
										previous
										4
										next
										6
										Total number
										6
Section								Drawing number	Scale 1:1	

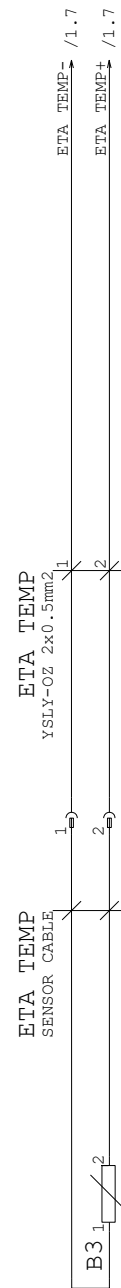

M1
 Pt1000
 SUPPLY FAN-1
 EBM 8300100866
 8400102493
 1.5kW / 2.3A
 K FACTOR: 190

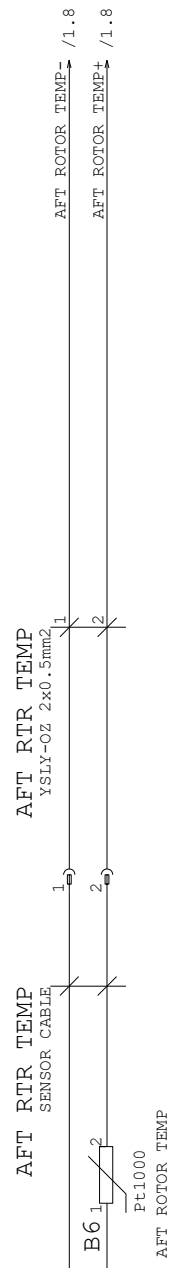
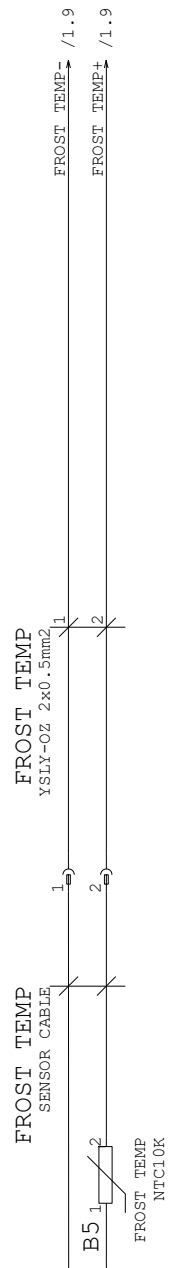
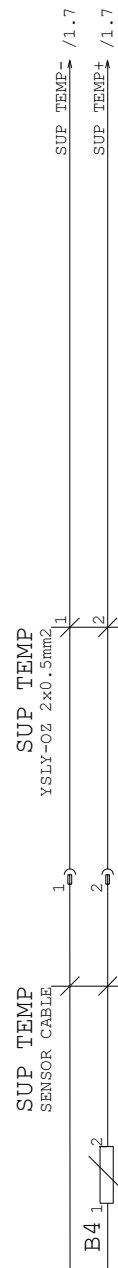
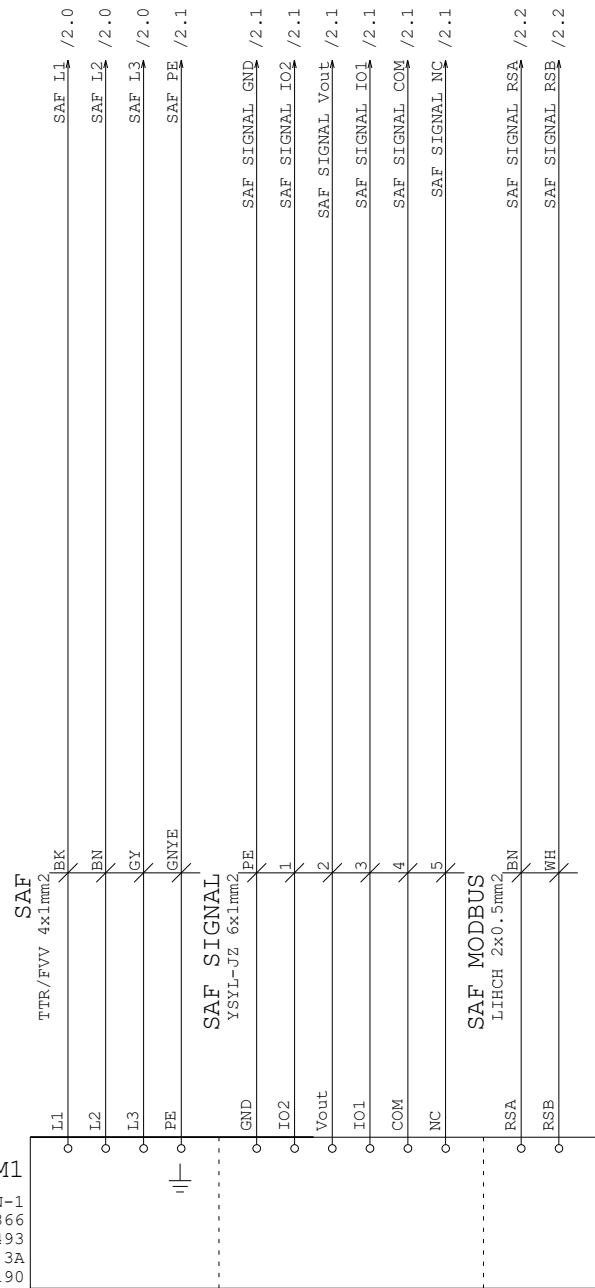

Status	Rev.	Date	Name	Date	Drawn by	Checked by	Standard	Project Name	Sheet current
									6
									previous
									5
									next
Section								Drawing number	Total number
								Scale 1:1	6