

Unit Type:
Project Unit Type:
Project: VALLOX-SR1000
Order Number:
Project Name
Manufacturing Date: 25.12.2025

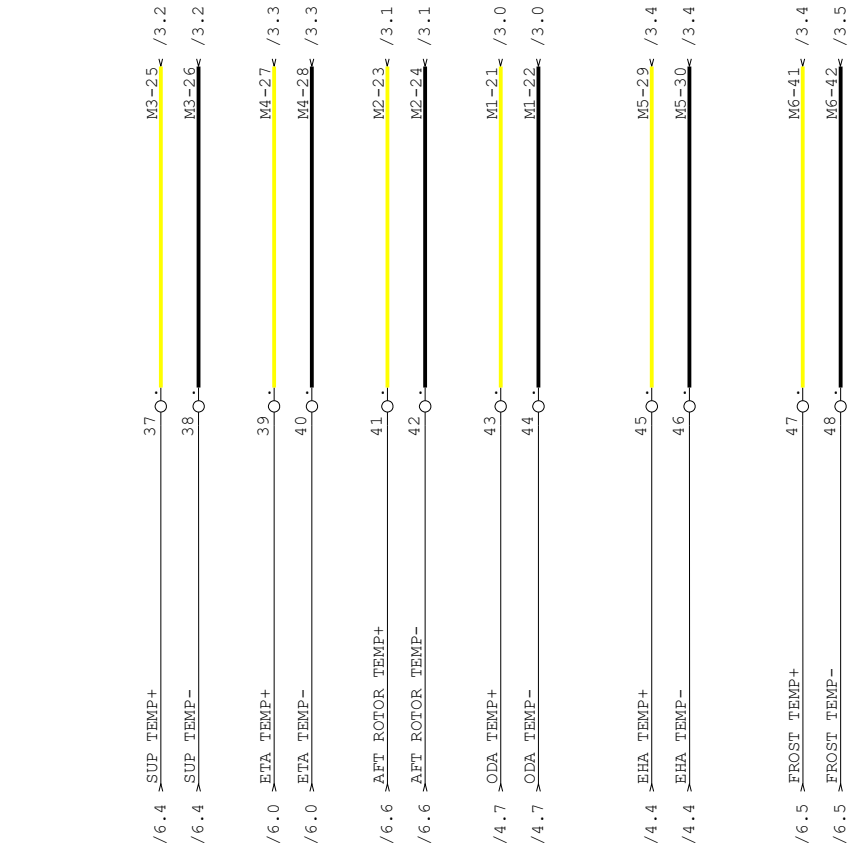
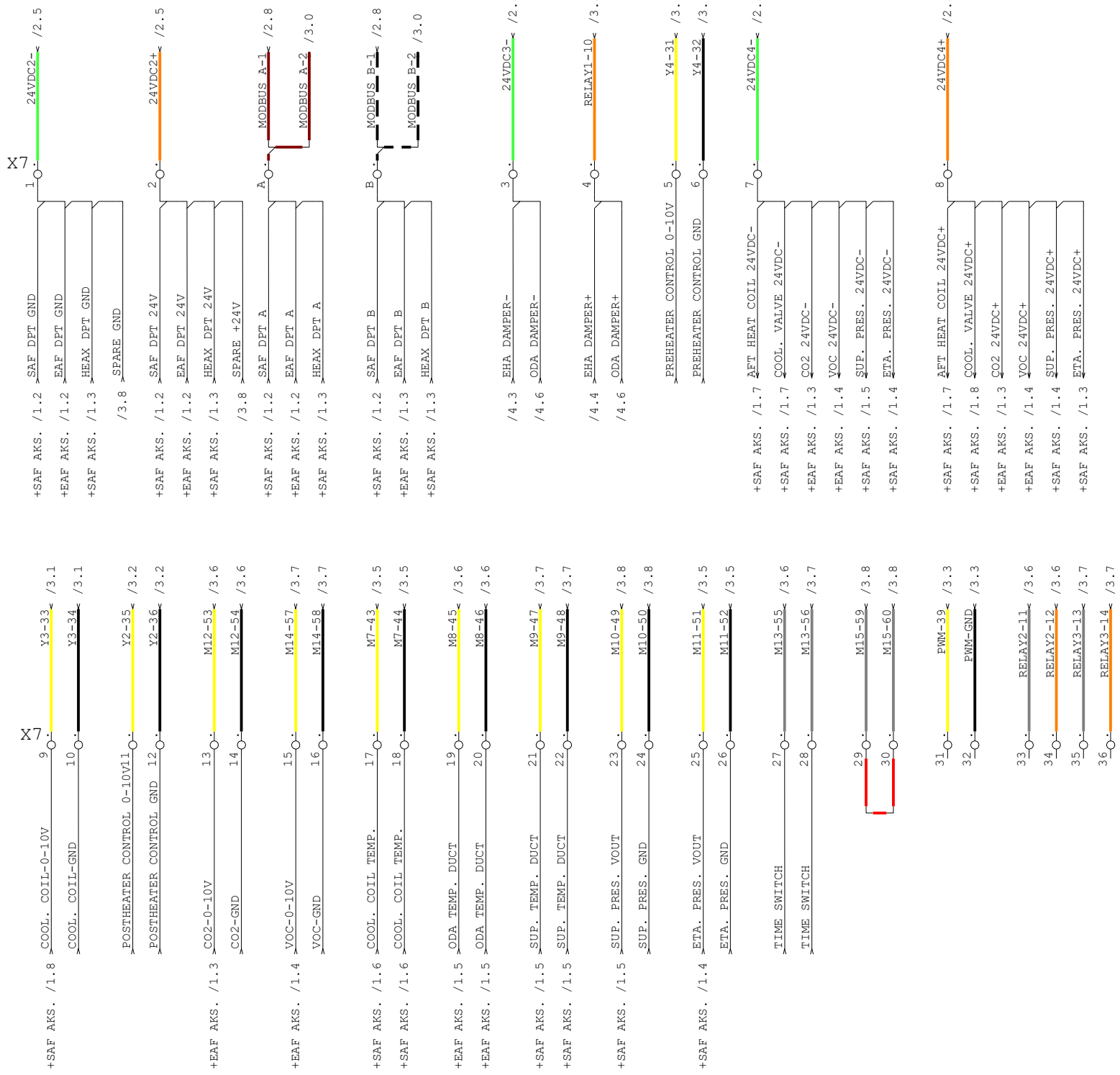
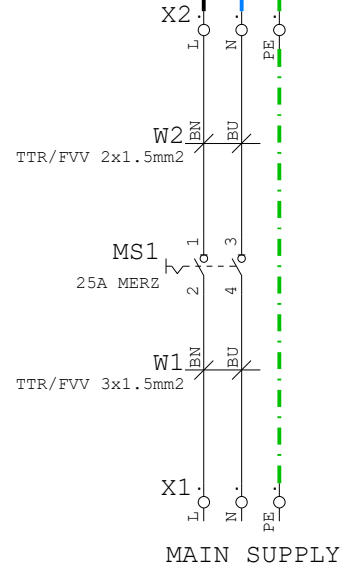

Status	Rev.	Date	Name	Date	Drawn by	Checked by	Standard	Project Name		Sheet
										current
										1
										previous
										next
										2
										Total
										number
										6

MAIN SUPPLY

Scale
1:1

Drawing number

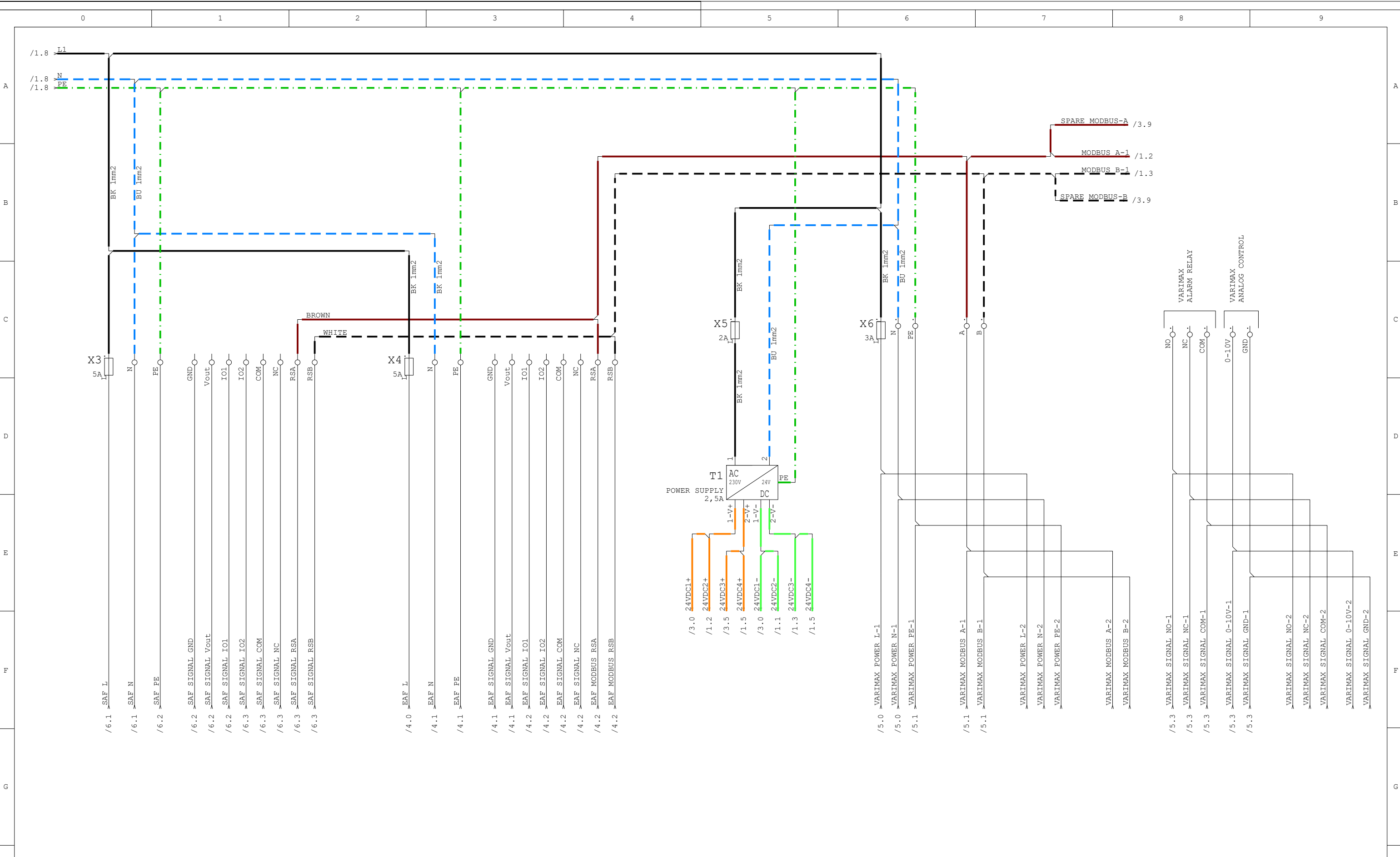

Status	Rev.	Date	Name	Date	Drawn by	Checked by	Standard	Project Name		Sheet	
										2	current previous 1 next 3 Total number 6
Section								Drawing number		Scale 1:1	

M2
 EXHAUST FAN
 EBM - 8300100876
 800 W / 3.5 A
 K FACTOR: 145
 V= 3600 m3/h

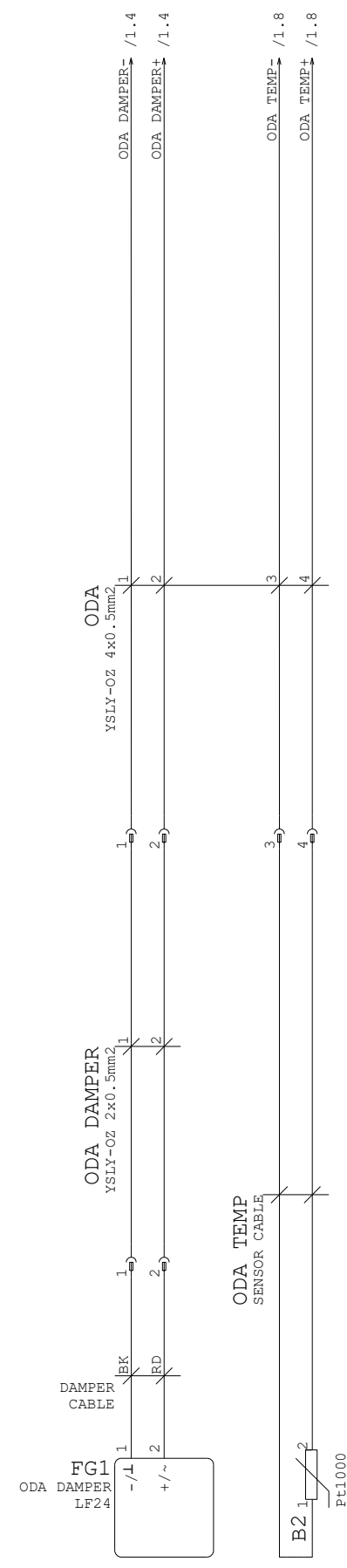
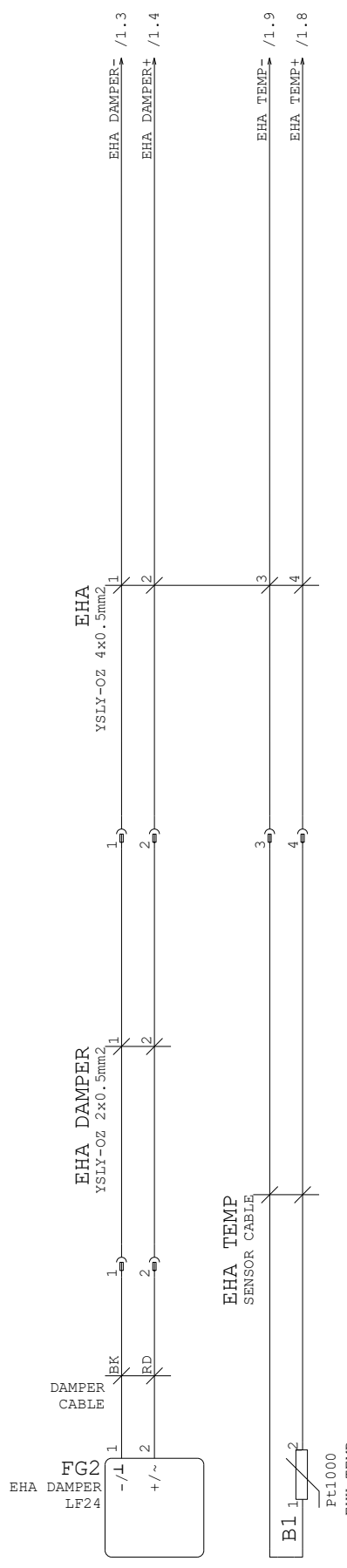
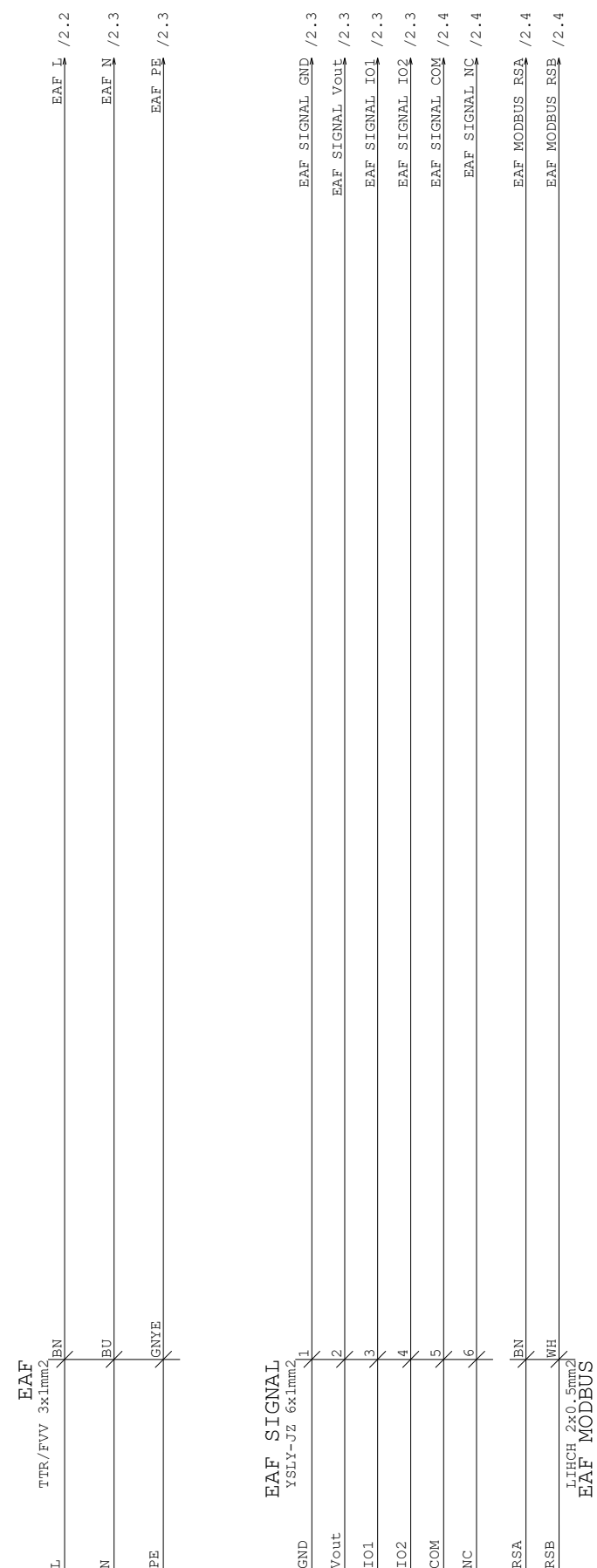

Status	Rev.	Date	Name	Date	Drawn by	Checked by	Standard	Project Name		Sheet	
										current	4
										previous	3
										next	5
										Total	6
Section								Drawing number		Scale 1:1	

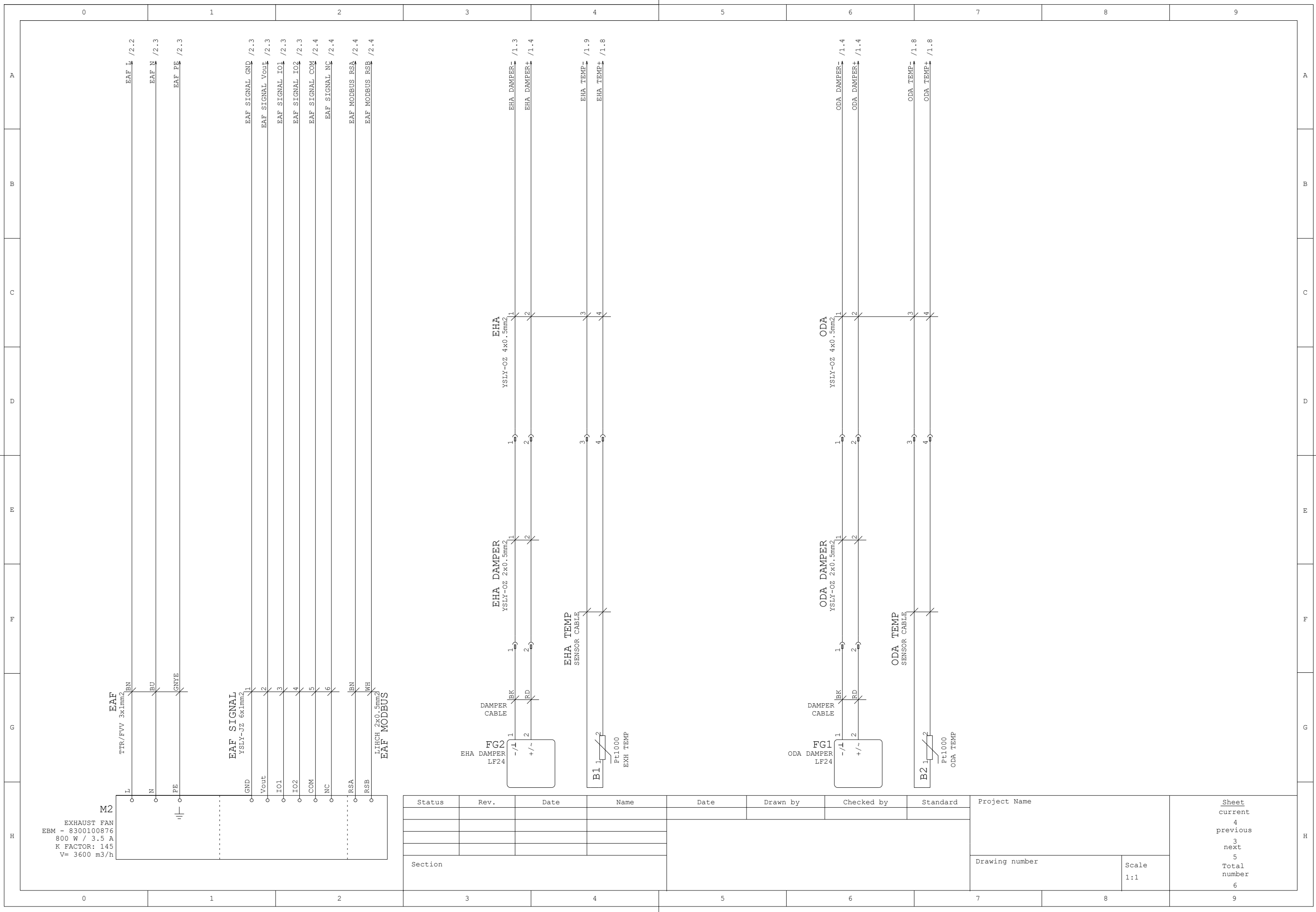

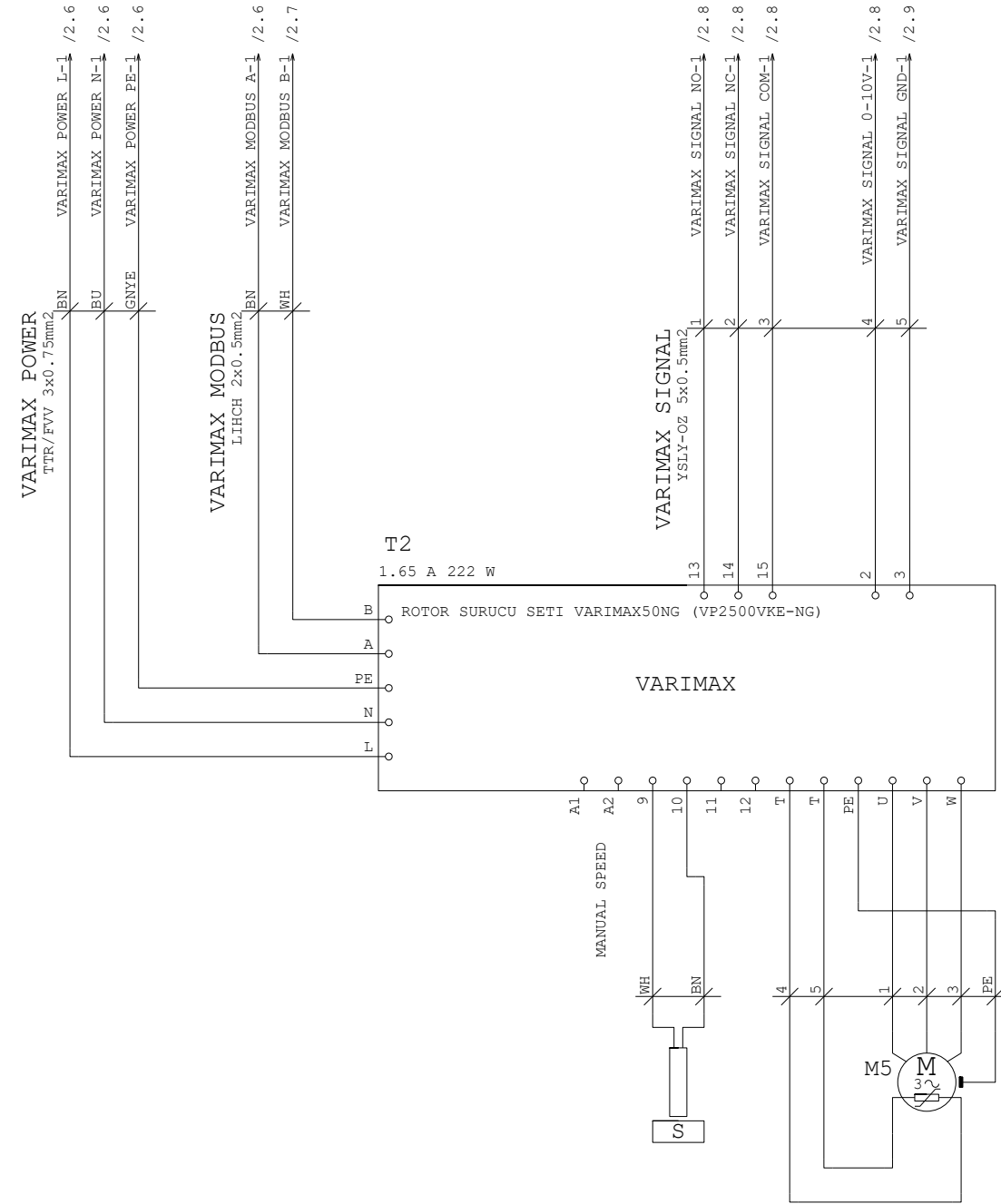

Status	Rev.	Date	Name	Date	Drawn by	Checked by	Standard	Project Name		Sheet current
										5
										previous
										4
										next
										6
										Total number
										6
Section								Drawing number	Scale 1:1	

