

Unit Type:
Project Unit Type:
Project: VALLOX-SR3000_REV
Order Number:
Project Name
Manufacturing Date: 25.12.2025

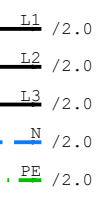

Status	Rev.	Date	Name	Date	Drawn by	Checked by	Standard	Project Name		Sheet current	
										1 previous	
Section								Drawing number		next	
								Scale 1:1		2 Total number	
										6	

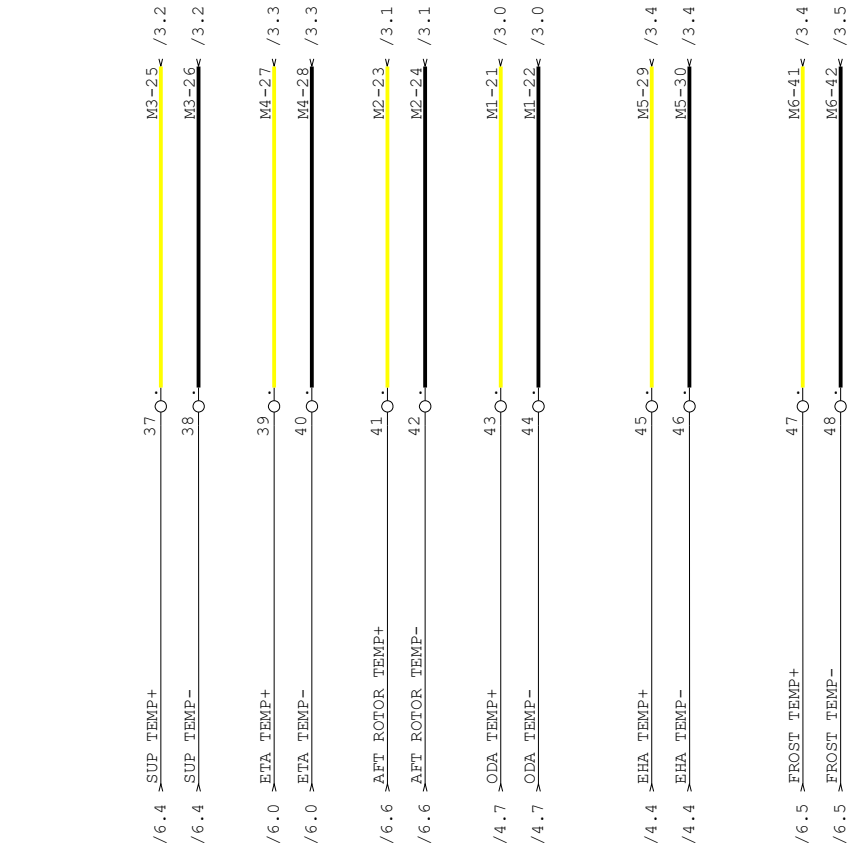
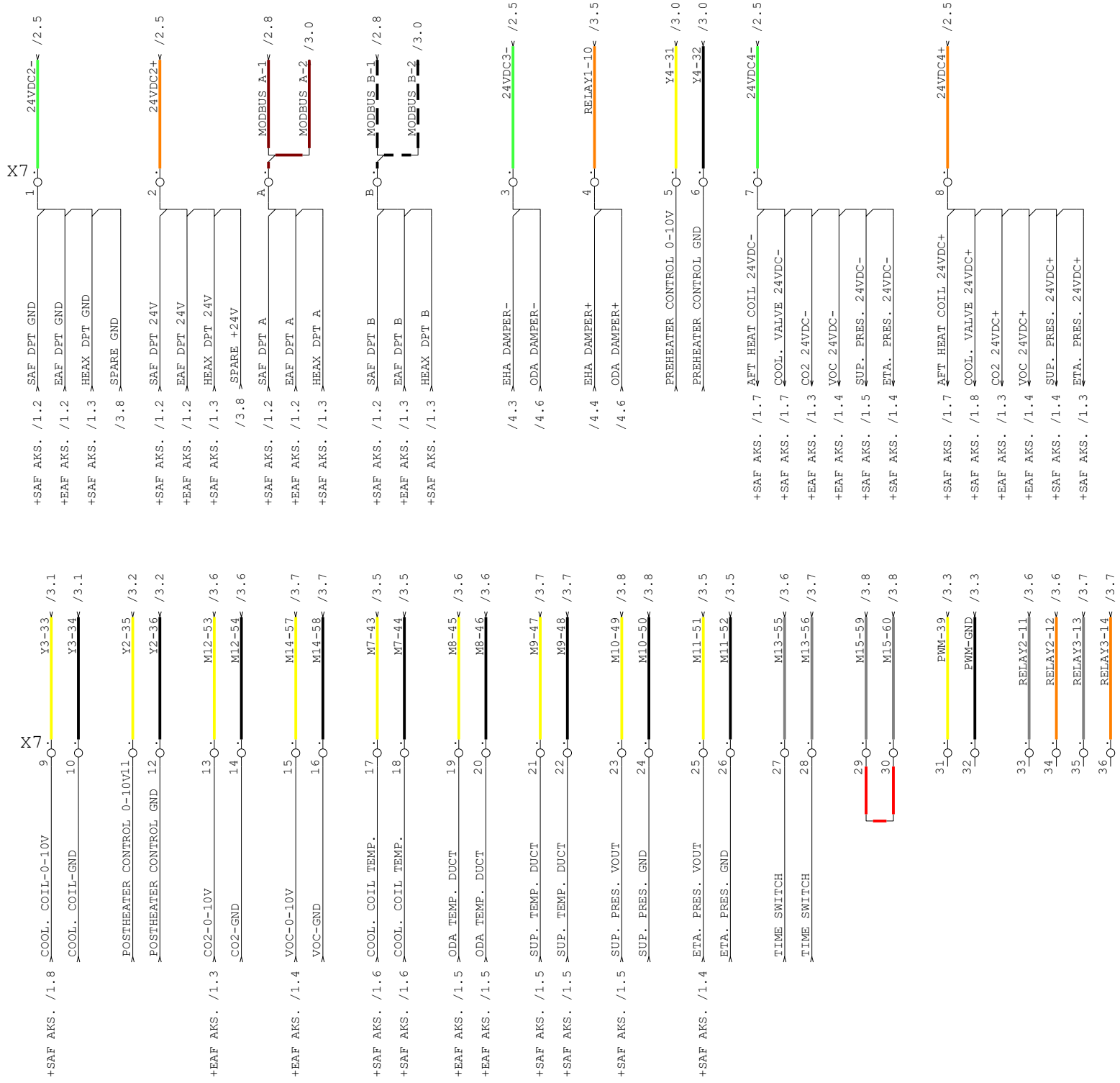
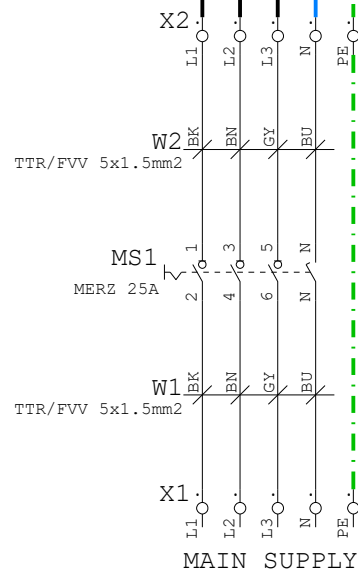
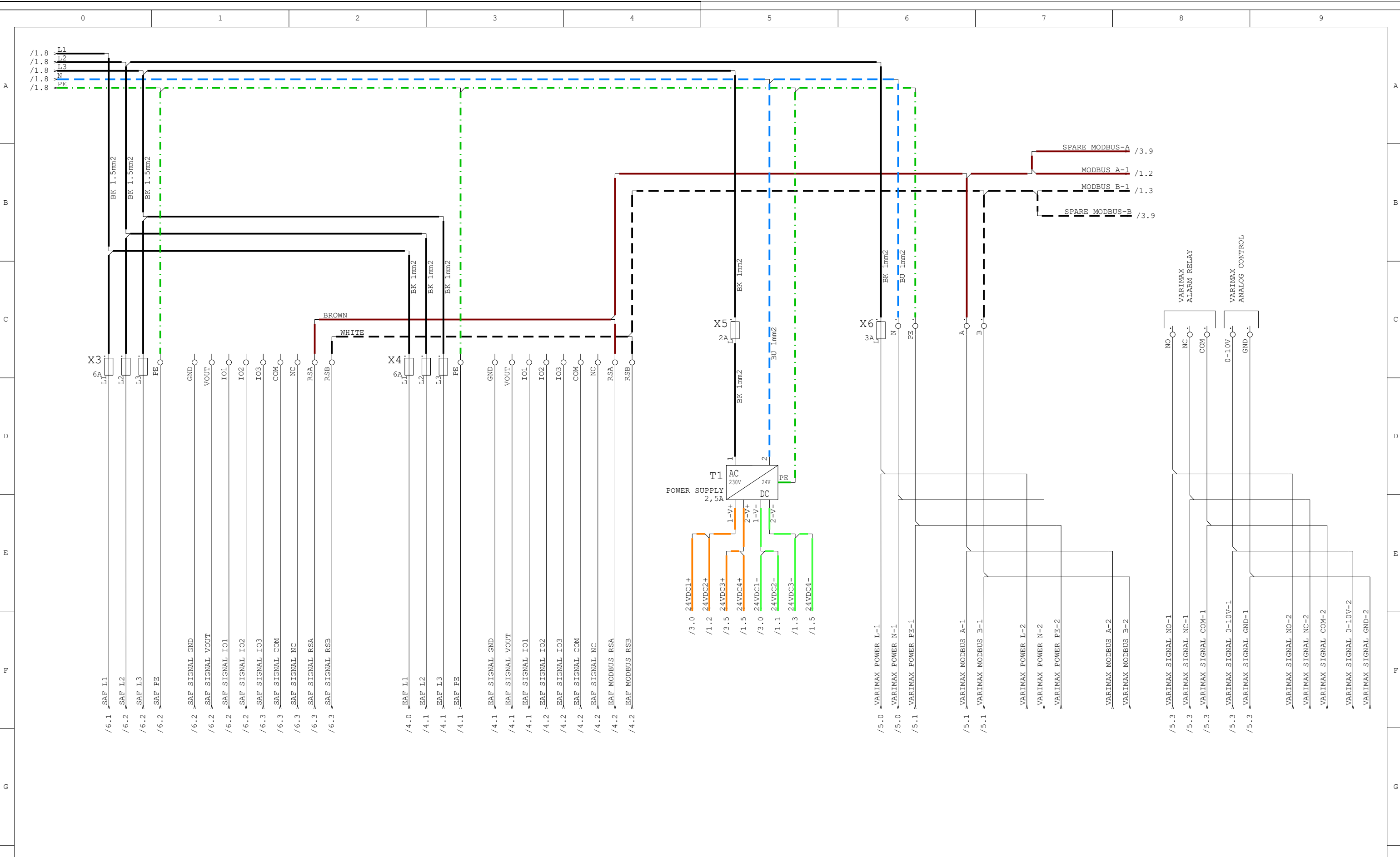

Status	Rev.	Date	Name	Date	Drawn by	Checked by	Standard	Project Name		Sheet	
										current	
										2	
										previous	
										1	
										next	
										3	
										Total	
										number	
										6	
Section								Drawing number		Scale	
										1:1	

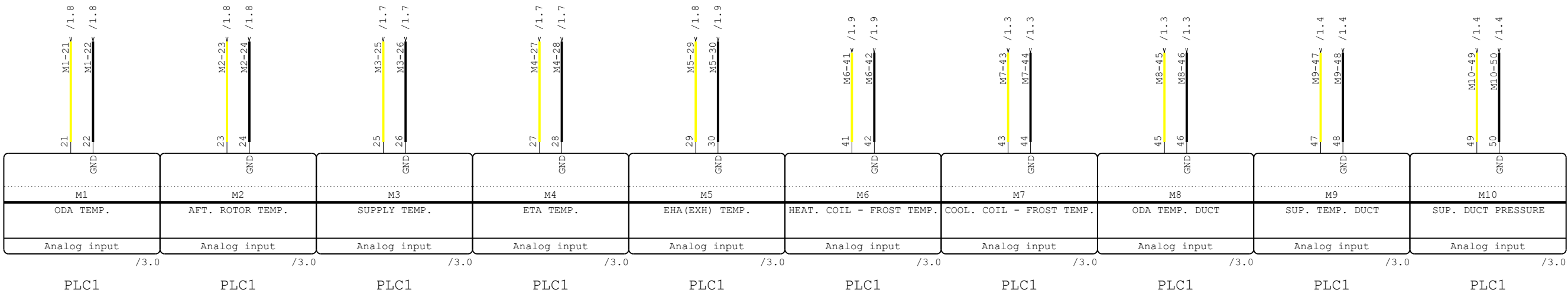
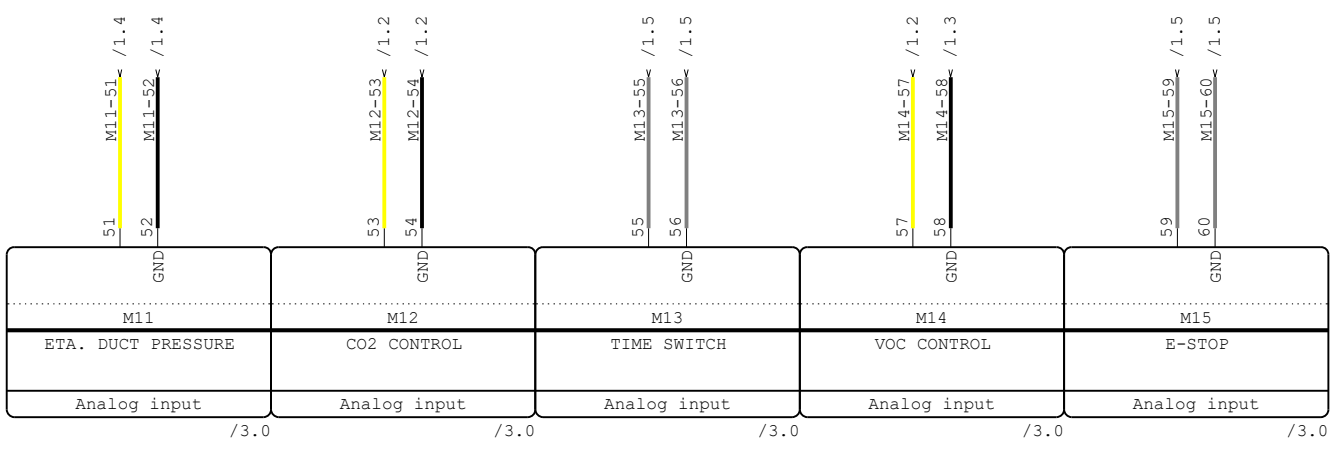
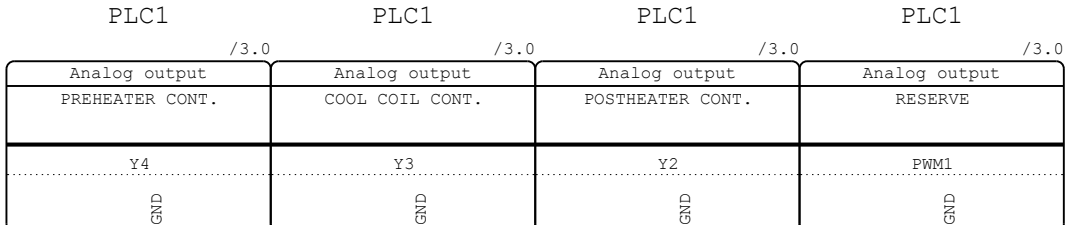
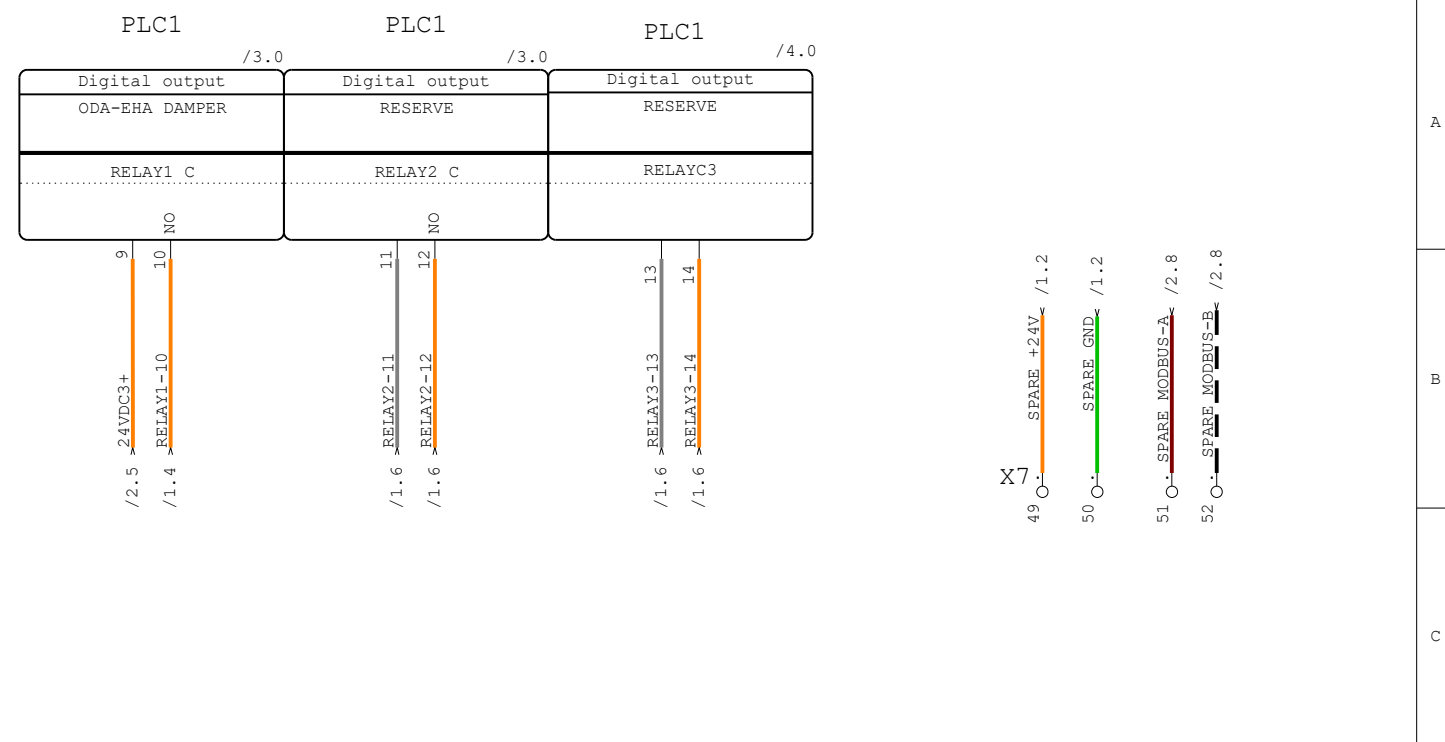
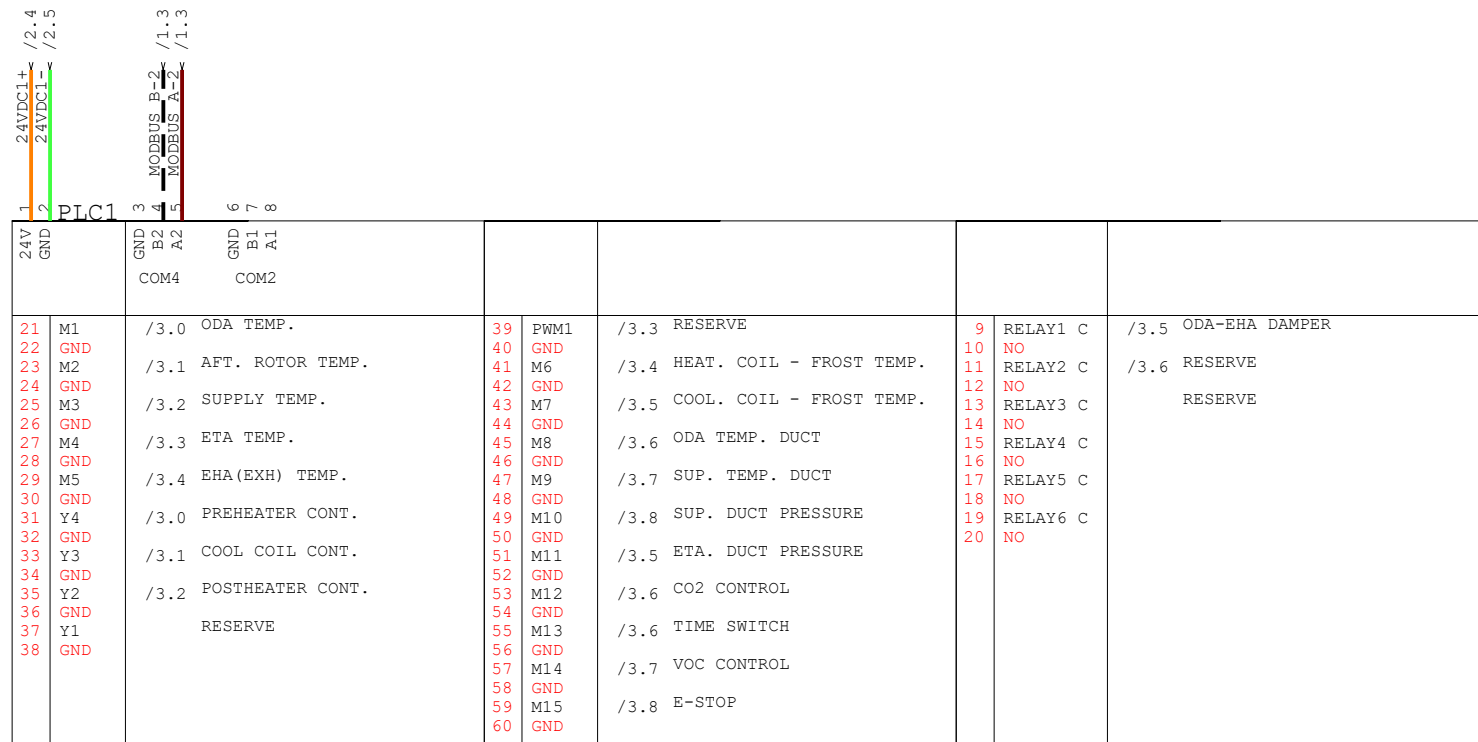

Status	Rev.	Date	Name	Date	Drawn by	Checked by	Standard	Project Name	Sheet current
									3
									previous
									2
									next
									4
									Total number
									6

0 1 2 3 4 5 6 7 8 9

A B C D E F G H

M2
EXHAUST FAN-1
R3G500-FA28-03
2.85kW / 4.4A
K FACTOR: 375
V= 10800m3/h

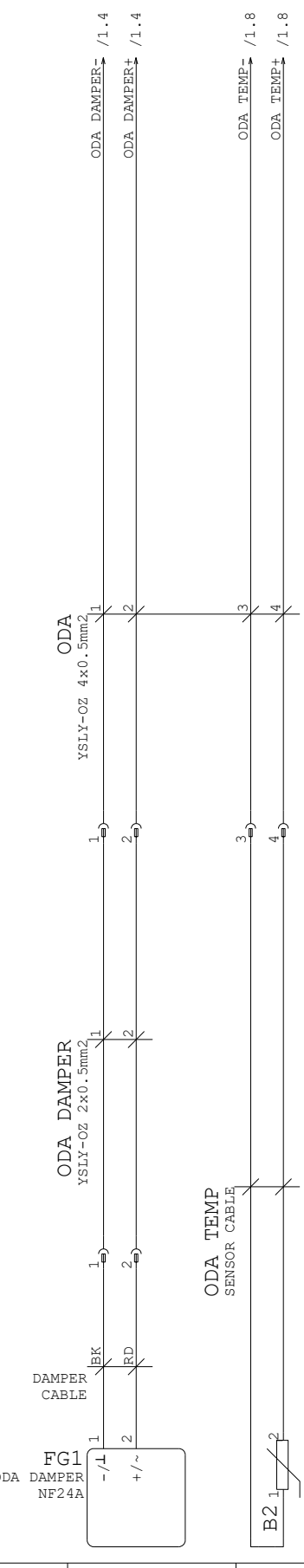
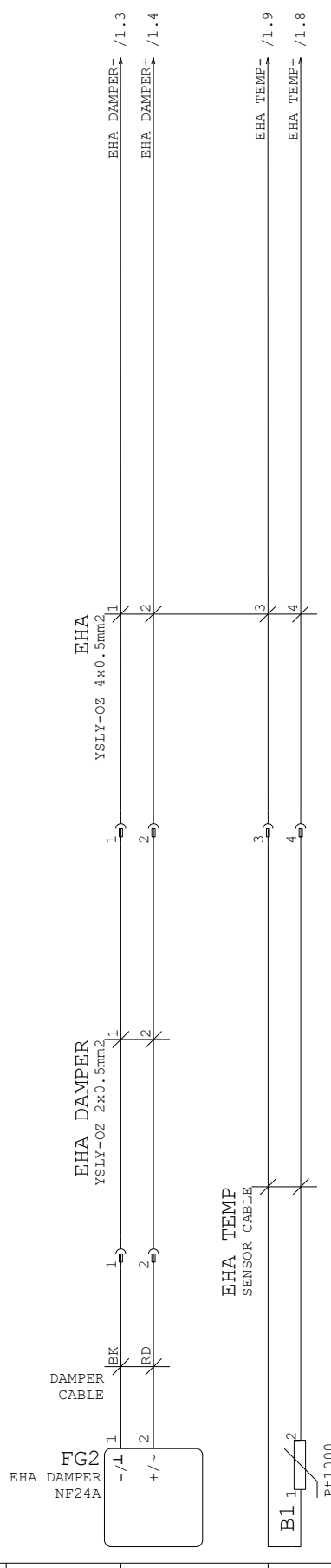
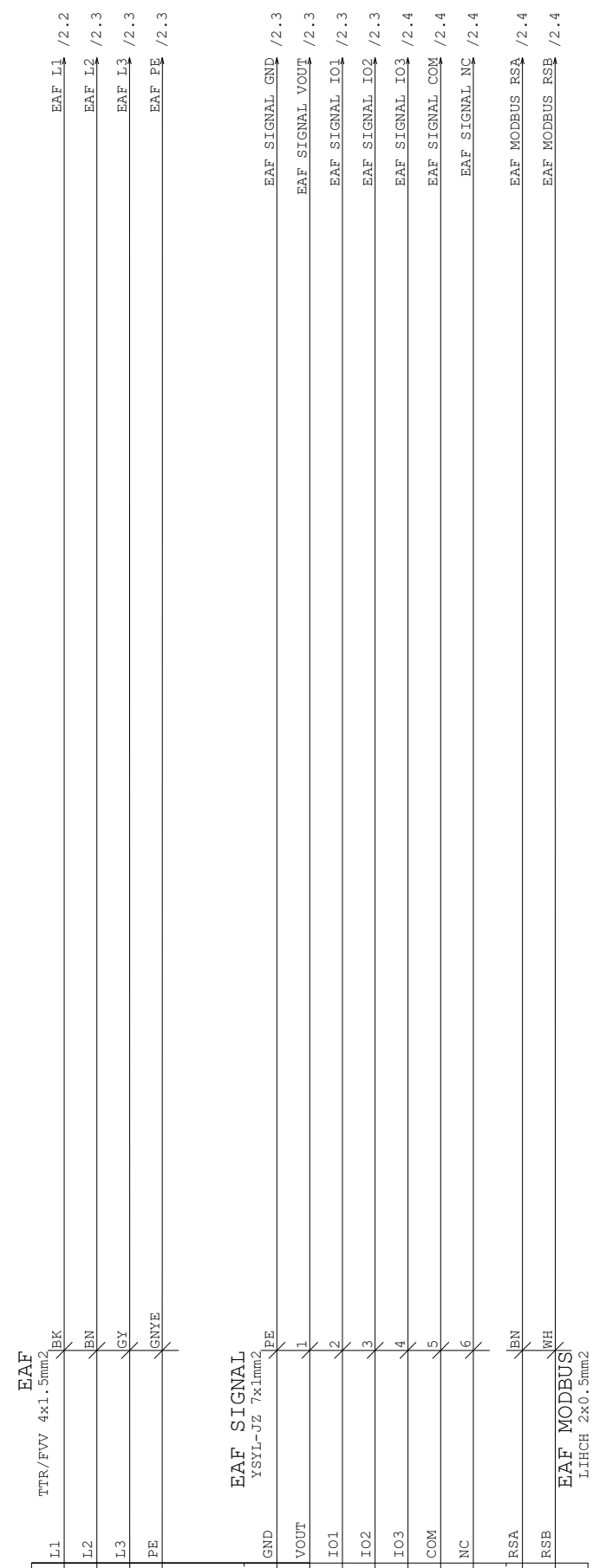

Status	Rev.	Date	Name	Date	Drawn by	Checked by	Standard	Project Name		Sheet	
										current	4
										previous	3
										next	5
										Total	6
Section								Drawing number		Scale 1:1	

0 1 2 3 4 5 6 7 8 9

H

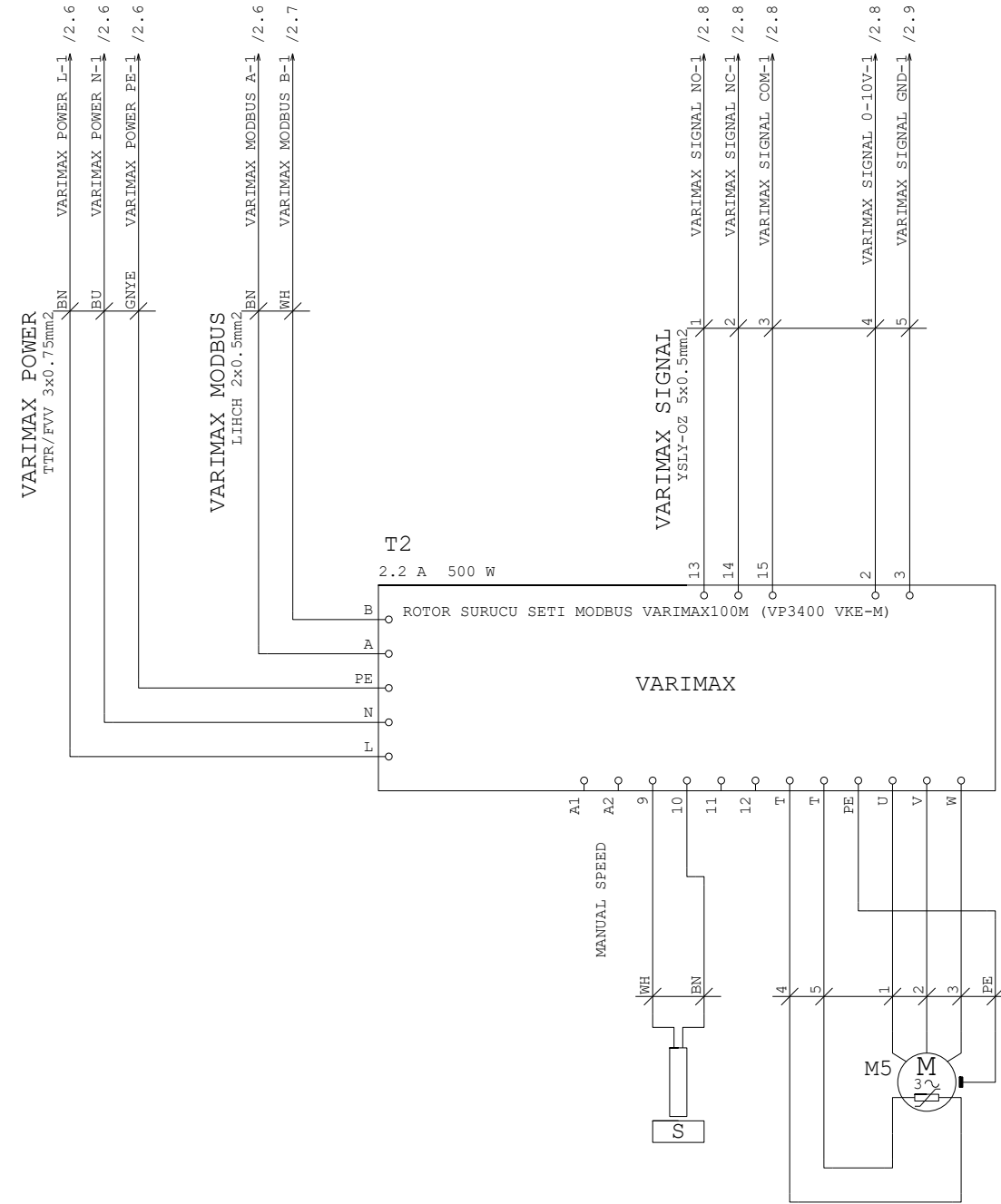

Status	Rev.	Date	Name	Date	Drawn by	Checked by	Standard	Project Name		Sheet current
										5
										previous
										4
										next
										6
Section								Drawing number	Scale	Total number
									1:1	6

