

Unit Type:
Project Unit Type:
Project: VALLOX SX2000
Order Number:
Project Name :
Manufacturing Date: 06.02.2026

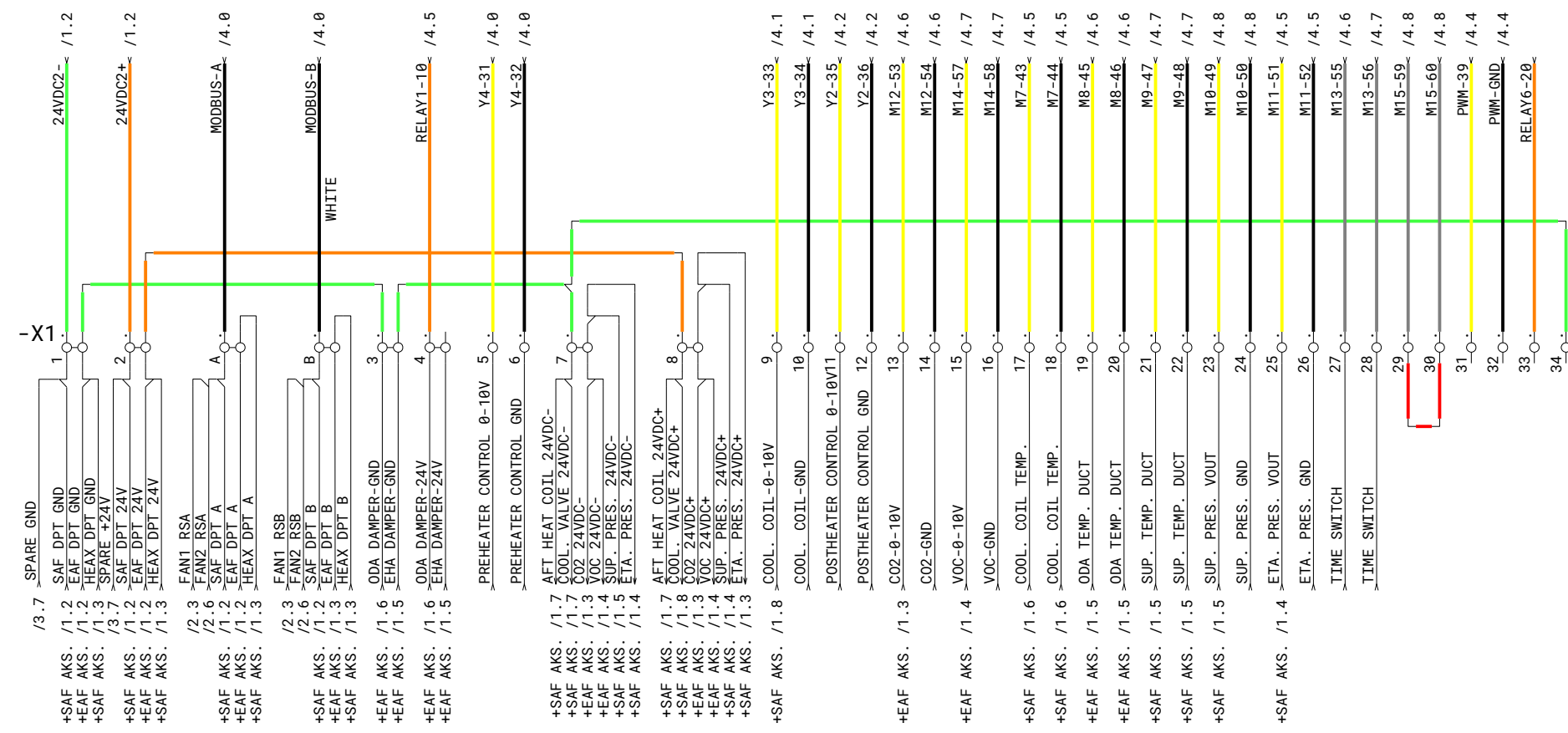

Status	Rev.	Date	Name	Date	Drawn by	Checked by	Standard	Project Name		Sheet current 1 previous next 2 Total number 6
								Drawing number	Scale	

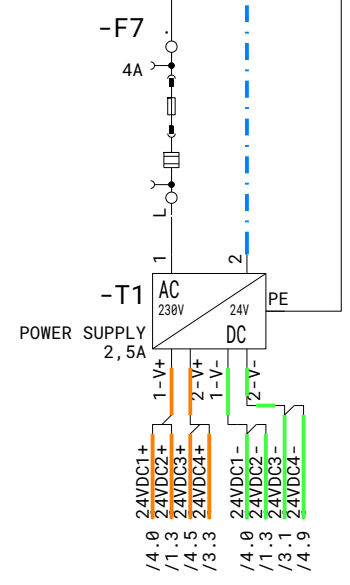
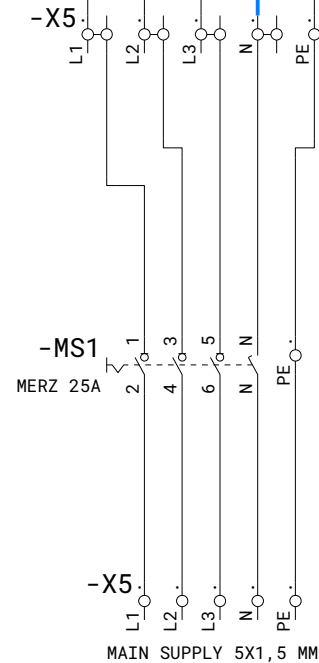
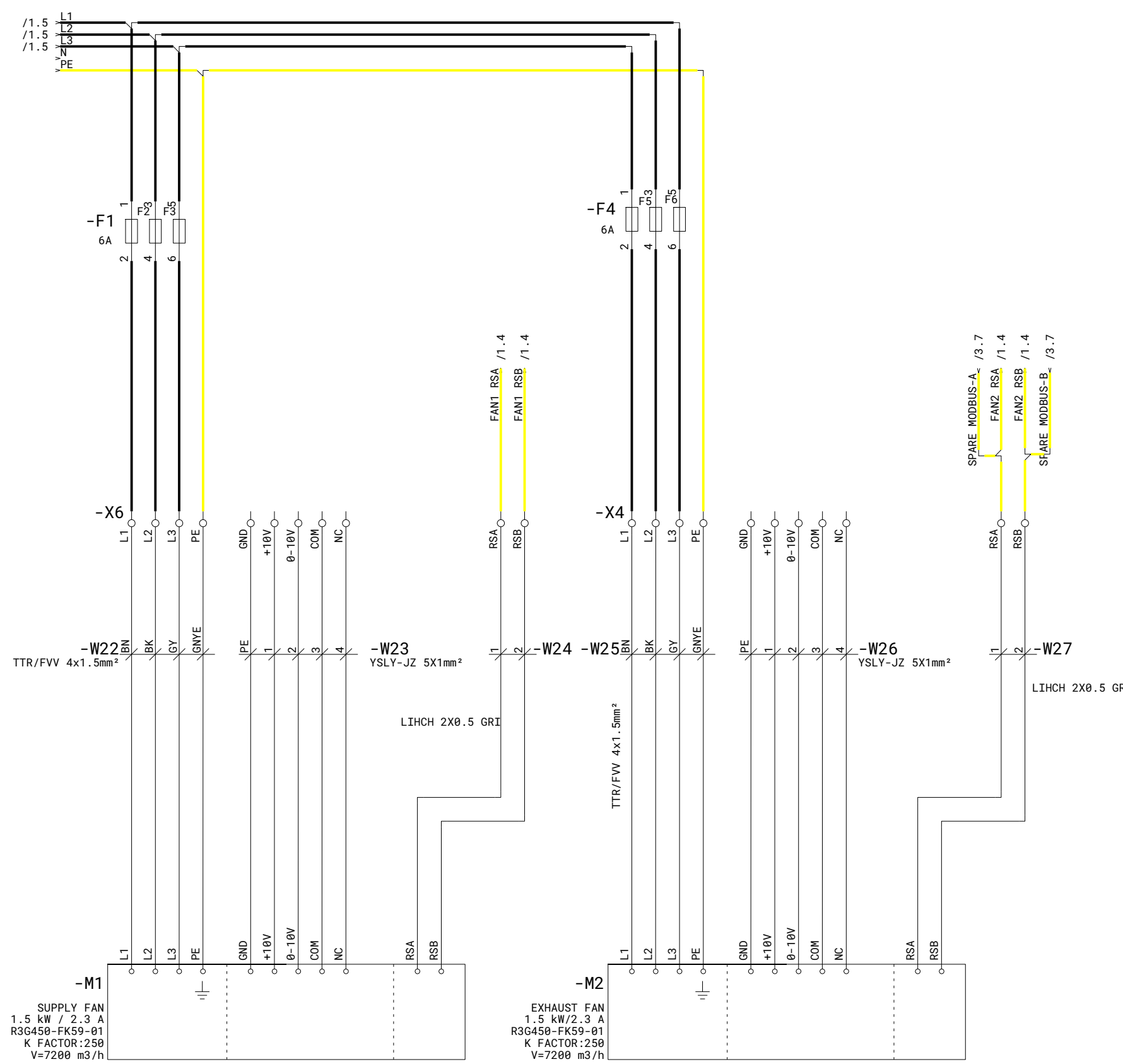

-M1
 SUPPLY FAN
 1.5 kW / 2.3 A
 R3G450-FK59-01
 K FACTOR:250
 V=7200 m3/h

-M2
 EXHAUST FAN
 1.5 kW/2.3 A
 R3G450-FK59-01
 K FACTOR:250
 V=7200 m3/h

Status	Rev.	Date	Name	Date	Drawn by	Checked by	Standard	Project Name	Sheet current 2
									previous 1
									next 3
									Total number 6
								Drawing number	Scale

0 1 2 3 4 5 6 7 8 9

A

B

C

D

E

F

G

H

0 1 2 3 4 5 6 7 8 9

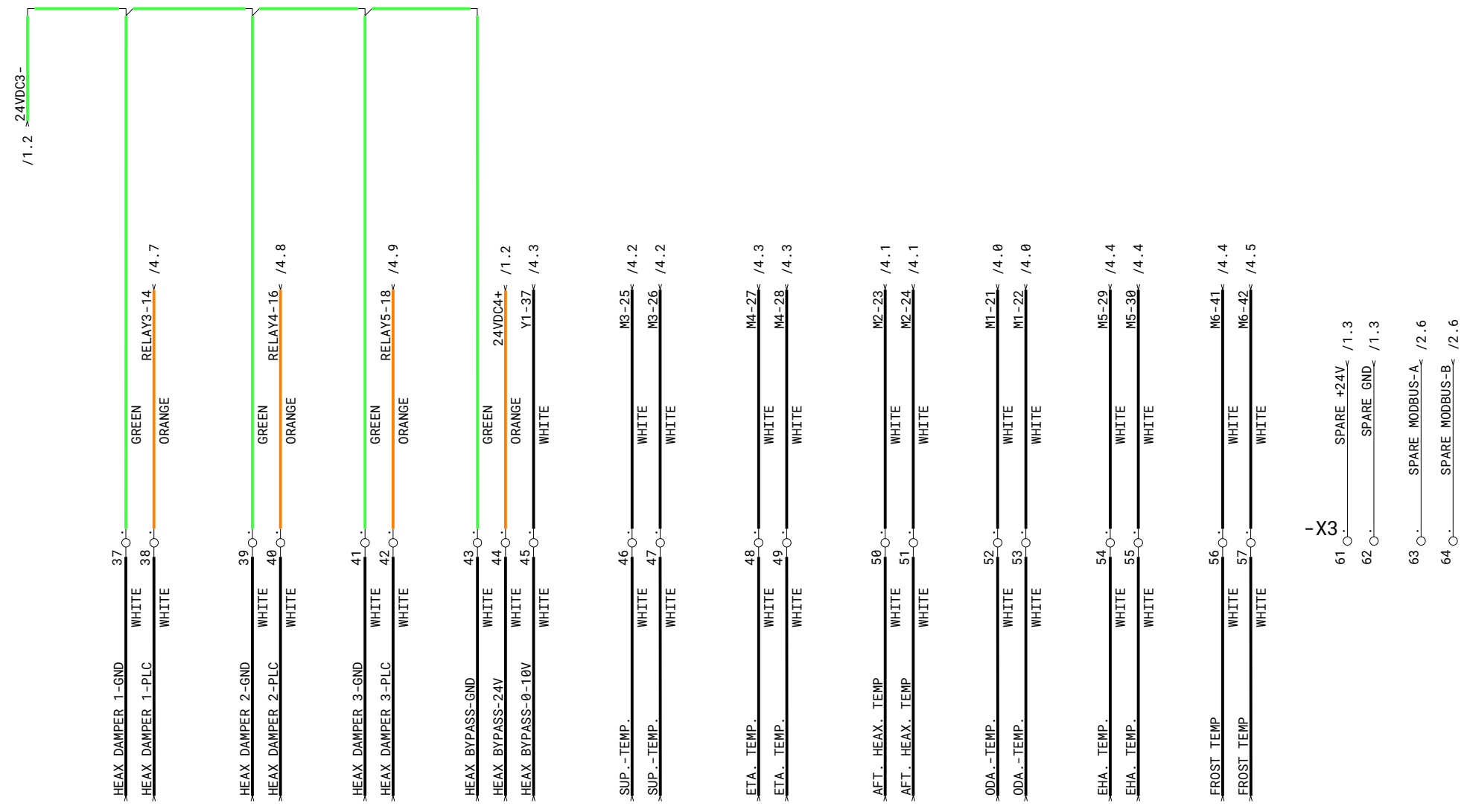

Status	Rev.	Date	Name	Date	Drawn by	Checked by	Standard	Project Name		Sheet current 3 previous 2 next 4 Total number 6
								Drawing number	Scale	

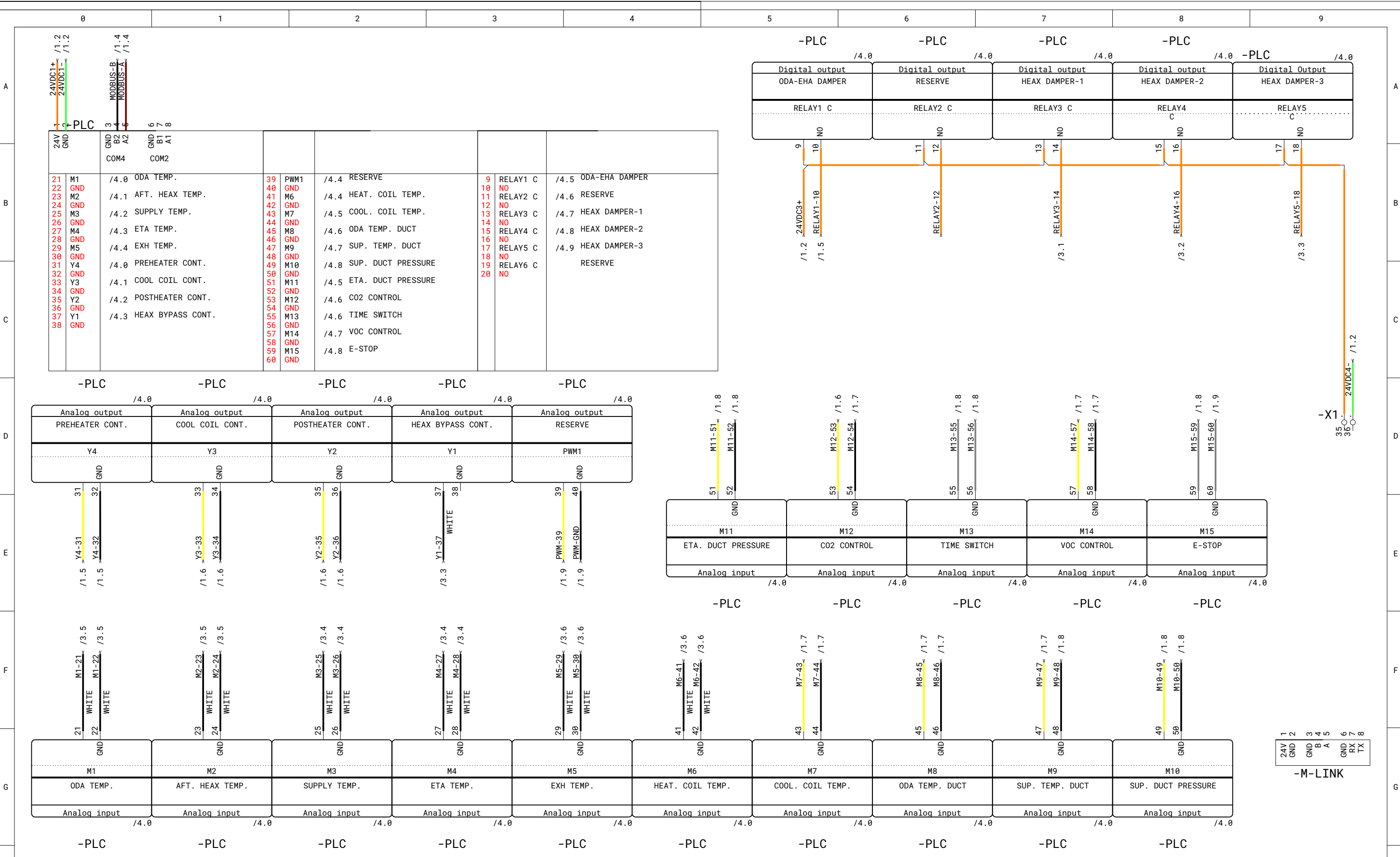

Status	Rev.	Date	Name	Date	Drawn by	Checked by	Standard	Project Name	Sheet current
									4
									previous
									3
									next
									5
									Total
									number
									6

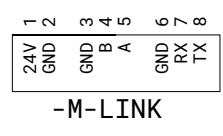

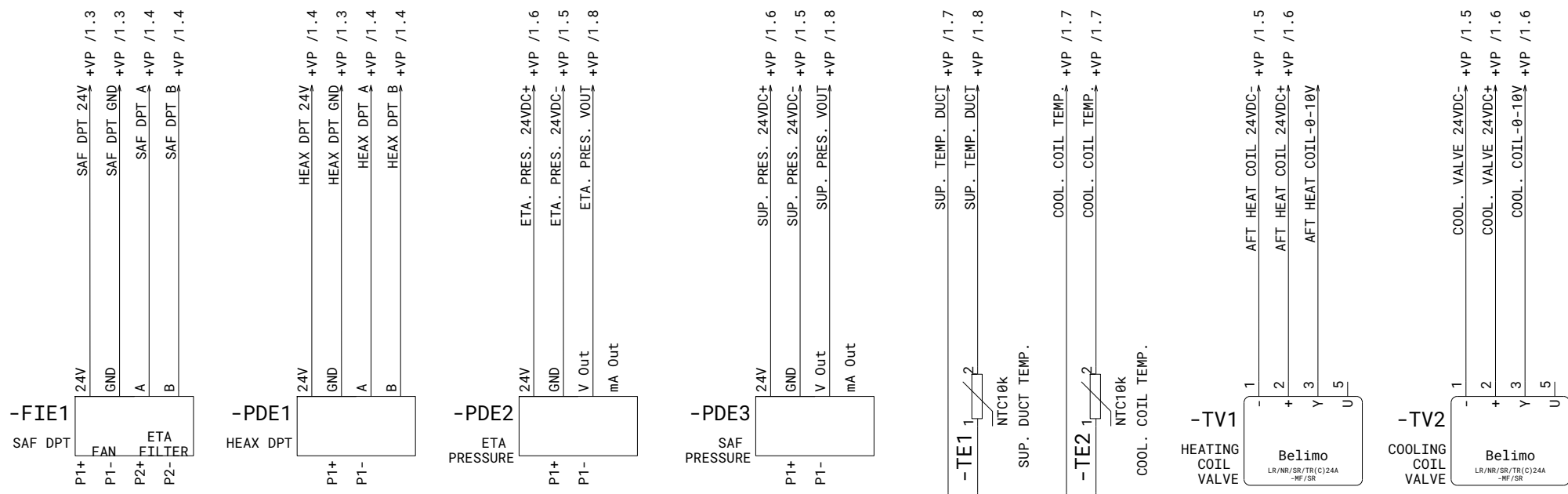

Status	Rev.	Date	Name	Date	Drawn by	Checked by	Standard	Project Name		Sheet current 5 previous 4 next 6 Total number 6
Section								Drawing number	Scale	

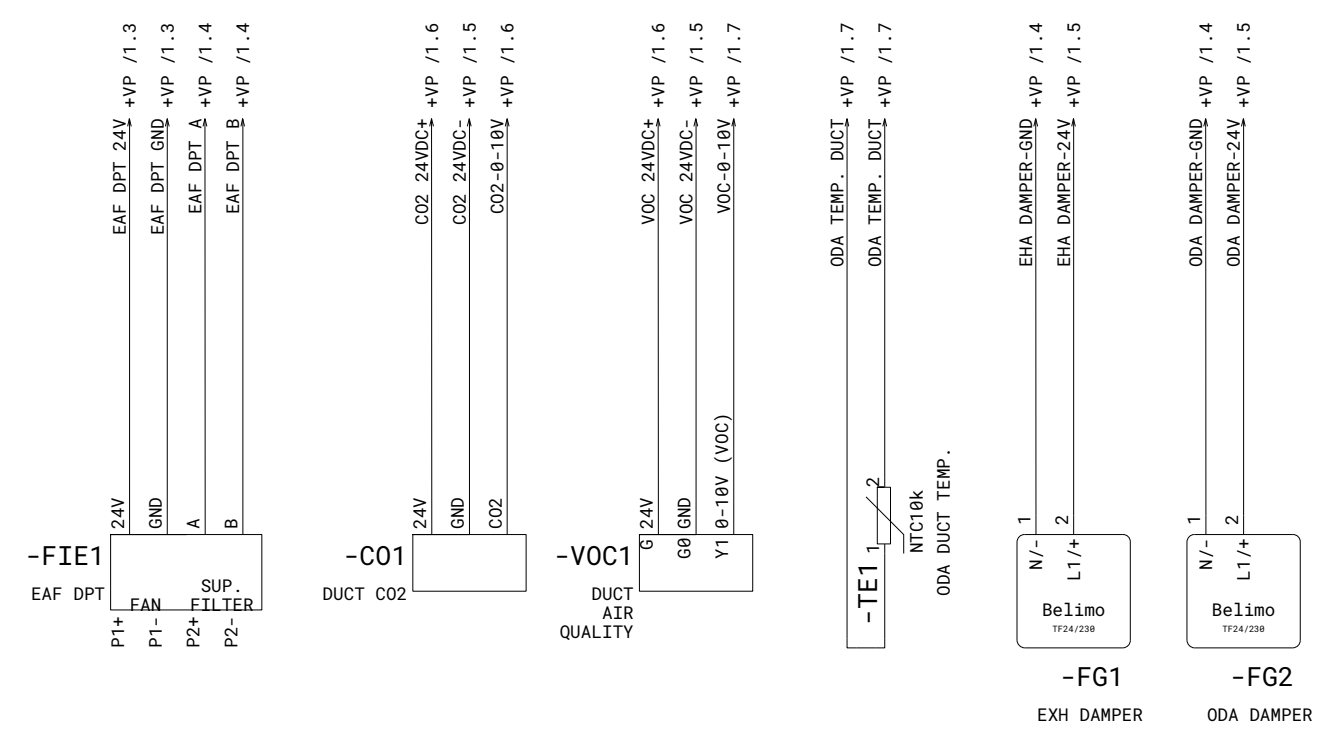

Status	Rev.	Date	Name	Date	Drawn by	Checked by	Standard	Project Name		Sheet current 6
										previous 5
Section								Drawing number	Scale	Total number 6