

Unit Type:  
Project Unit Type:  
Project: VALLOX-SX 3000  
Order Number:  
Project Name :  
Manufacturing Date: 06.02.2026

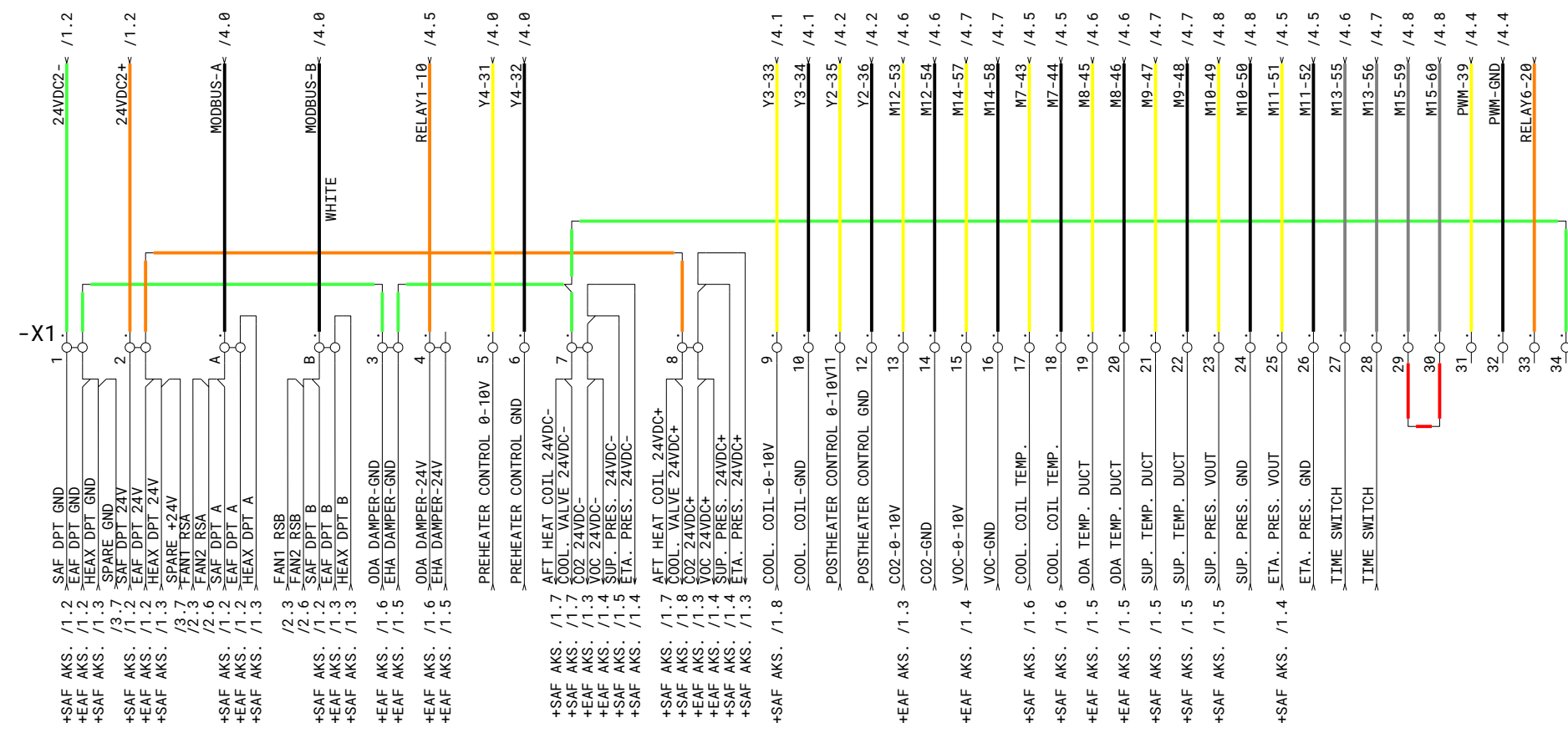

Status	Rev.	Date	Name	Date	Drawn by	Checked by	Standard	Project Name		Sheet current 1 previous next 2 Total number 6
								Drawing number	Scale	

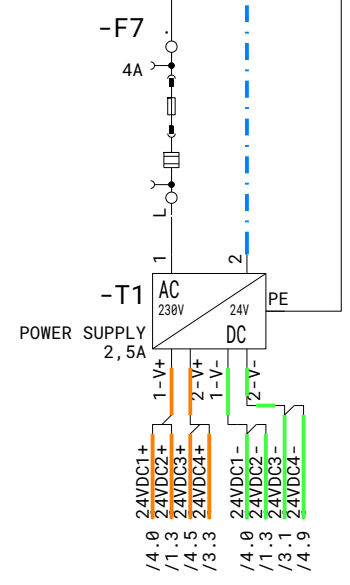
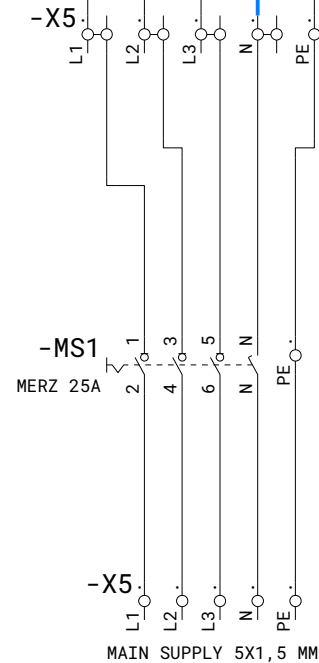
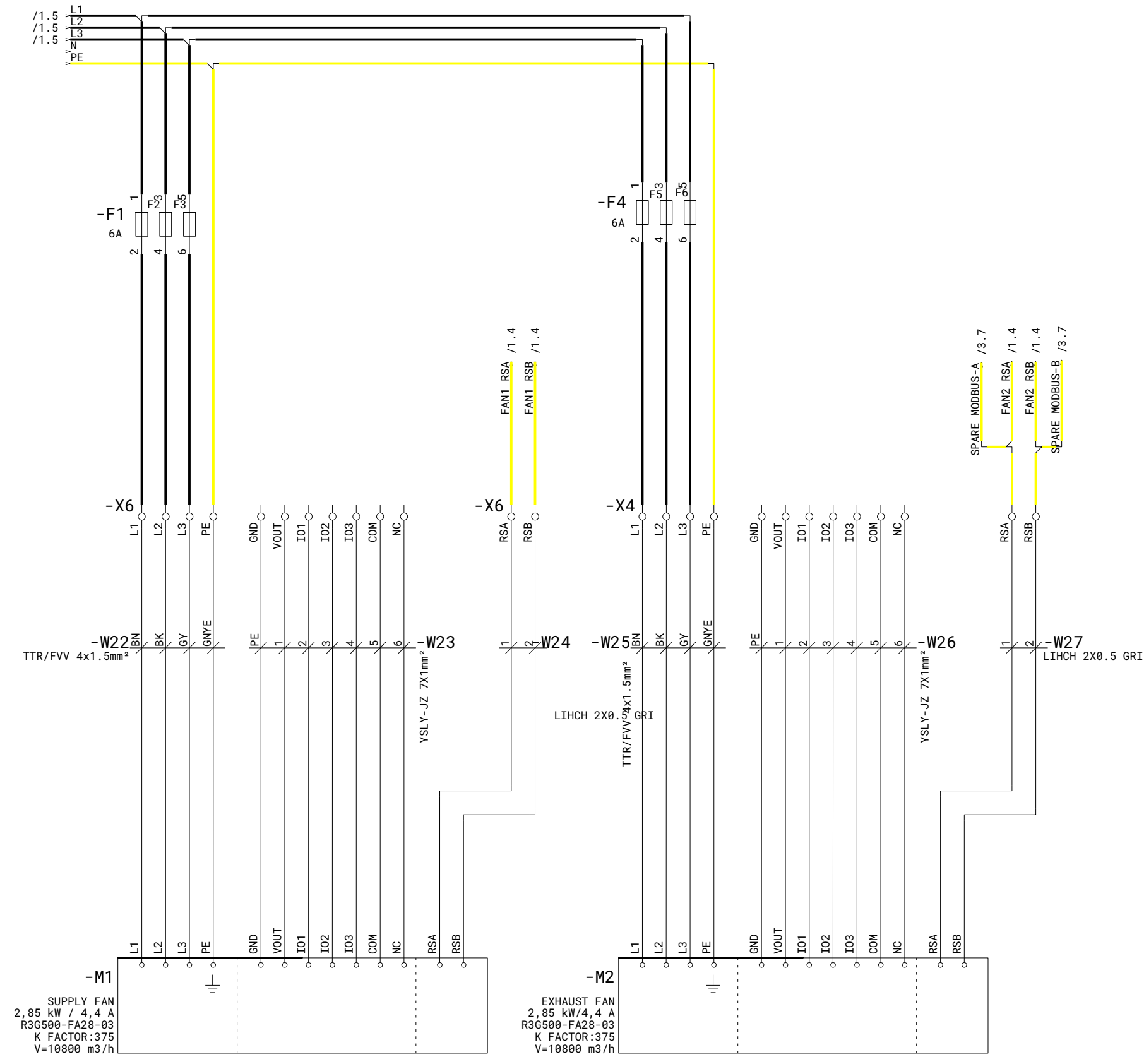

**-M1**  
 SUPPLY FAN  
 2,85 kW / 4,4 A  
 R3G500-FA28-03  
 K FACTOR:375  
 V=10800 m³/h

**-M2**  
 EXHAUST FAN  
 2,85 kW/4,4 A  
 R3G500-FA28-03  
 K FACTOR:375  
 V=10800 m³/h

Status	Rev.	Date	Name	Date	Drawn by	Checked by	Standard	Project Name	Sheet current 2
									previous 1
									next 3
									Total number 6
								Drawing number	Scale

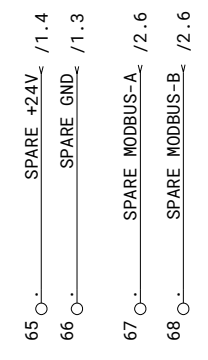
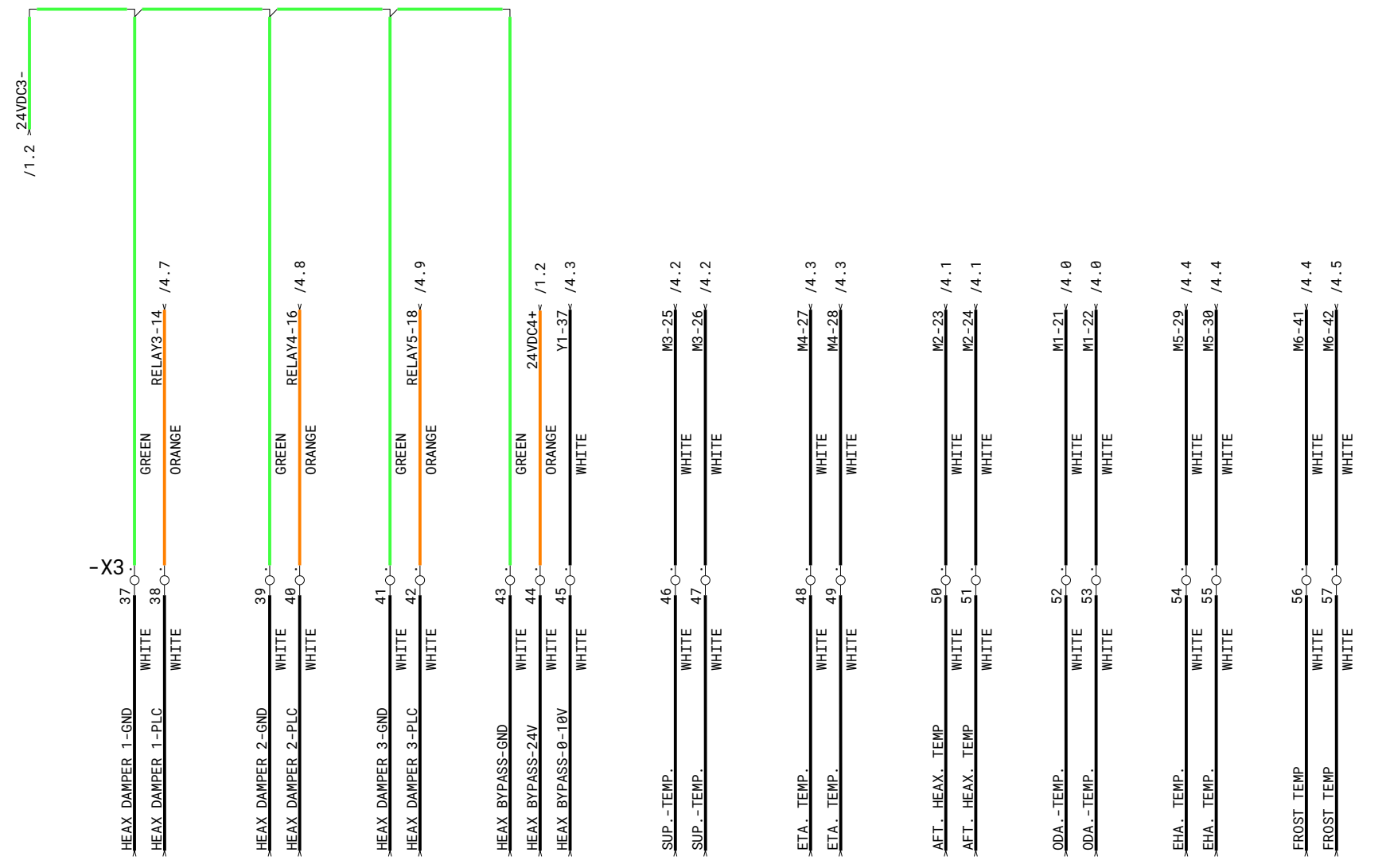

Status	Rev.	Date	Name	Date	Drawn by	Checked by	Standard	Project Name		Sheet current 3 previous 2 next 4 Total number 6
								Drawing number	Scale	

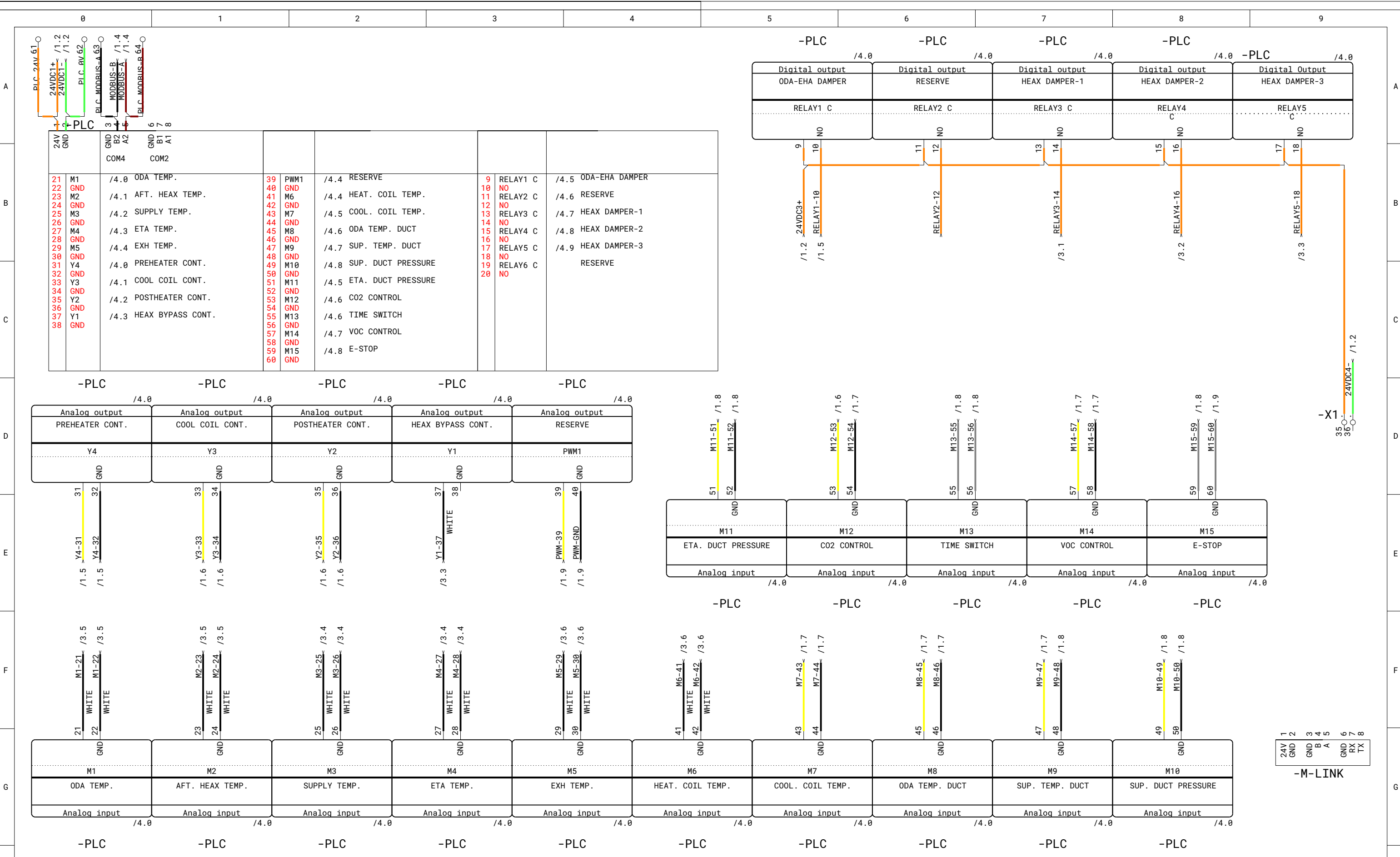

21	M1	/4.0	ODA TEMP.	39	PWM1	/4.4	RESERVE	9	RELAY1 C	/4.5	ODA-EHA DAMPER
22	GND			40	GND			10	NO		
23	M2	/4.1	AFT. HEAX TEMP.	41	M6	/4.4	HEAT. COIL TEMP.	11	RELAY2 C	/4.6	RESERVE
24	GND			42	GND			12	NO		
25	M3	/4.2	SUPPLY TEMP.	43	M7	/4.5	COOL. COIL TEMP.	13	RELAY3 C	/4.7	HEAX DAMPER-1
26	GND			44	GND			14	NO		
27	M4	/4.3	ETA TEMP.	45	M8	/4.6	ODA TEMP. DUCT	15	RELAY4 C	/4.8	HEAX DAMPER-2
28	GND			46	GND			16	NO		
29	M5	/4.4	EXH TEMP.	47	M9	/4.7	SUP. TEMP. DUCT	17	RELAY5 C	/4.9	HEAX DAMPER-3
30	GND			48	GND			18	NO		
31	Y4	/4.0	PREHEATER CONT.	49	M10	/4.8	SUP. DUCT PRESSURE	19	RELAY6 C		RESERVE
32	GND			50	GND			20	NO		
33	Y3	/4.1	COOL COIL CONT.	51	M11	/4.5	ETA. DUCT PRESSURE				
34	GND			52	GND						
35	Y2	/4.2	POSTHEATER CONT.	53	M12	/4.6	CO2 CONTROL				
36	GND			54	GND						
37	Y1	/4.3	HEAX BYPASS CONT.	55	M13	/4.6	TIME SWITCH				
38	GND			56	GND						
				57	M14	/4.7	VOC CONTROL				
				58	GND						
				59	M15	/4.8	E-STOP				
				60	GND						

Status	Rev.	Date	Name	Date	Drawn by	Checked by	Standard	Project Name	Sheet current 4  previous 3 next 5 Total number 6
								Drawing number	
								Scale	

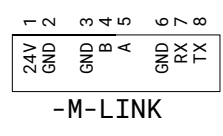

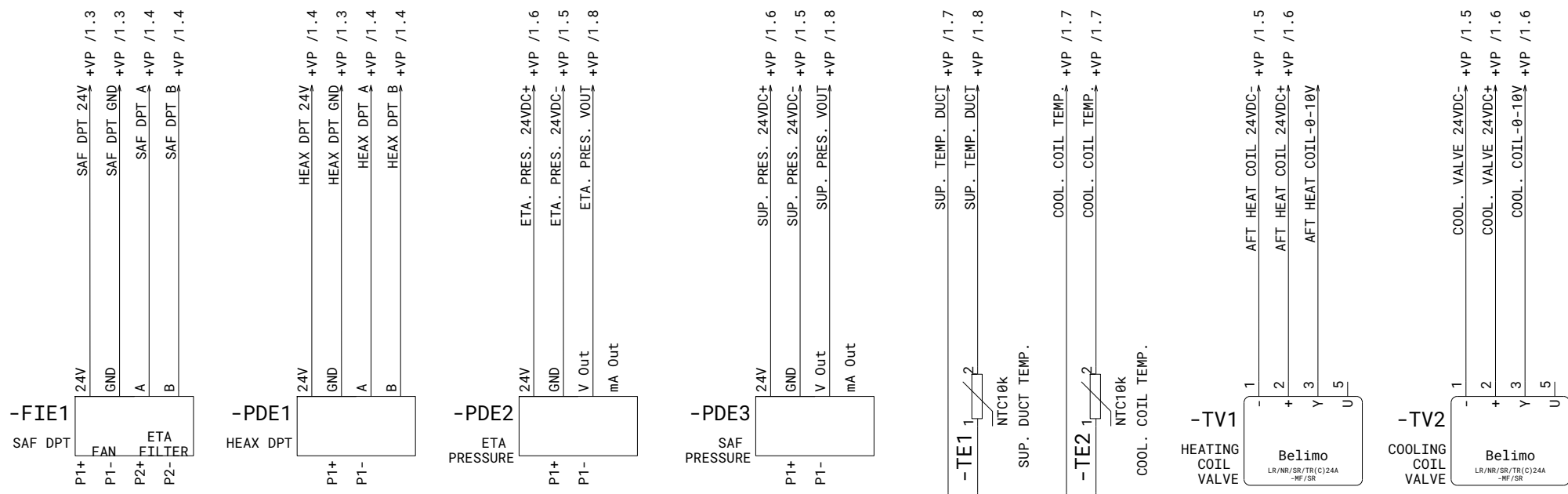

Status	Rev.	Date	Name	Date	Drawn by	Checked by	Standard	Project Name	Sheet current 5 previous 4 next 6 Total number 6
								Drawing number Scale	
Section									

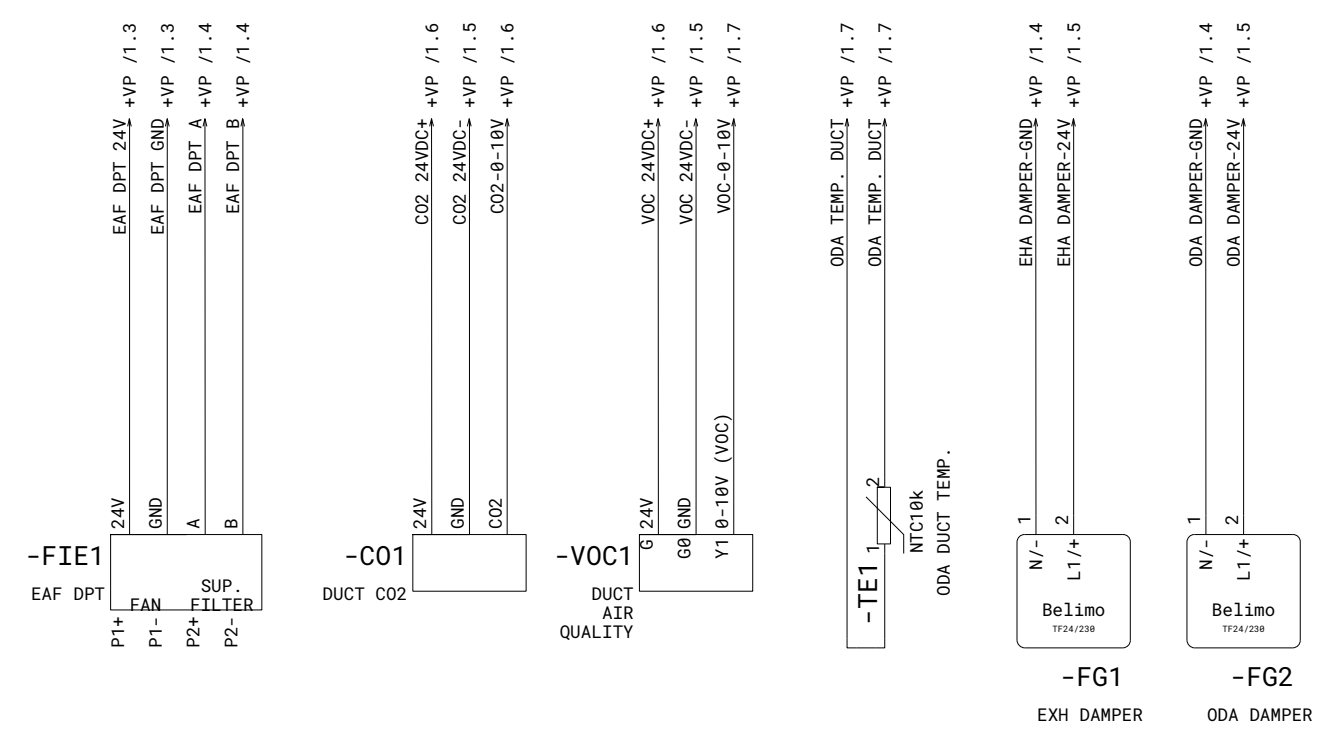

Status	Rev.	Date	Name	Date	Drawn by	Checked by	Standard	Project Name		Sheet current 6
										previous 5
Section								Drawing number	Scale	Total number 6