

THE DENTAL
SOLUTIONS
COMPANY™



The 2D x-ray family

dentsplysirona.com



As versatile as practice life

The Orthophos 2D X-ray family offers the right solution for every practice. From entry into digital radiography to the perfect solution for your area of specialty - Dentsply Sirona offers a product family sophisticated in every way with the ideal solution for every dentist.



Unbeatable digital advantages

Digital Imaging is becoming the standard in more and more dental practices. The benefits are obvious: lower radiation exposure and more brilliant images accompanied by more efficient data management. At the same time, both treatment methods and practice services can be clearly explained to the patient.

- Outstanding image quality with the lowest dose
- Optimum workflow to work more efficiently
- A variety of analysis tools for simplified diagnosis
- Elimination of the darkroom for more room in the practice
- Better patient integration
- Professional marketing of practice services
- No development with toxic chemicals





Work quickly, precisely and reliably

Dentsply Sirona imaging units stand out for their simple operation and positioning, thus providing efficient workflows. The unprecedented image quality allows extremely precise diagnosis and planning. With Dentsply Sirona, you trust a global brand with hundreds of thousands of units in practice distinguished by their Made in Germany quality.



Optimum Workflow



Unparalleled
image quality



Proven solution

Easy operation, safe positioning

Dentsply Sirona offers unique patented solutions for operating the units and positioning the patients. Optimize your practice workflow with intuitive user interfaces and automatic positioning aids that eliminate unnecessary corrective scans and waiting times.



The new positioning tools make for good imaging.

„Positioning with the Orthophos SL is very easy for our team. The many aids such as automatic light localizers, illuminated height adjustment buttons and intuitive program selection allow us to work efficiently with very good image quality. In combination with Sidexis 4, we have a comprehensive package that gives us absolute confidence in the findings.“

PD Dr. Dr. Lutz Ritter, Oral and Maxillofacial Surgery, Hennef



1 Intuitive operation

No matter how your X-ray room is set up – the swiveling and tilting EasyPad makes it highly flexible and the clearly arranged buttons and symbols ensure optimum operation.

2 The patented occlusal bite block

Position the patient with the patented occlusal bite block. The unit automatically determines the correct tilt of the head and indicates it using corresponding symbols and colors – all you need to do is press the up and down arrows.

3 Stable positioning for high-quality images

Stable patient positioning prevents motion blurring. The motorized 3-point head fixation and stable handles give your patients the necessary support. At the same time the integrated temple width measurement ensures an orbit specific to each patient and thereby results in high image sharpness.



Working digitally is this easy

Sidexis 4 - this is the core of the digital workflow with Dentsply Sirona.

The software with its intuitive user interface has a very simple structure: it follows the clear structure of your work processes and provides you at all times with all visual data of your patients seamlessly and at a glance - whether 2D, 3D or intraoral. This integrates your patients optimally and thus results in a high acceptance of your treatment proposal. Sidexis 4 is pure imaging efficiency, giving you a quick overview of the entire history of the patient. This allows you to add a time dimension to your diagnostic options in a very intuitive way. The lightbox is ideal for a comprehensive diagnosis, as it lets you compare 2D and 3D images as well as camera images and facescan data side-by-side.



Simple overview of the patient history

Advantages at a glance

- Modern design
- Software platform for all Sirona x-ray units
- Intuitive operation, optimally coordinated workflows
- Simple overview of the patient history thanks to the intuitive timeline
- Easy export of DICOM data sets
- Interface of the integrated solutions from Dentsply Sirona

Maximum image quality with the lowest dose

The Orthophos family has been developed according to the ALARA principle to allow the best X-ray images with the lowest radiation dose. All programs and image parameters are tailored to the specific diagnostic tasks while offering you more diagnostic options and gentle treatment at the same time.

Pediatric panoramic images

The horizontally and vertically reduced pediatric panoramic program achieves outstanding image quality with the lowest dose.

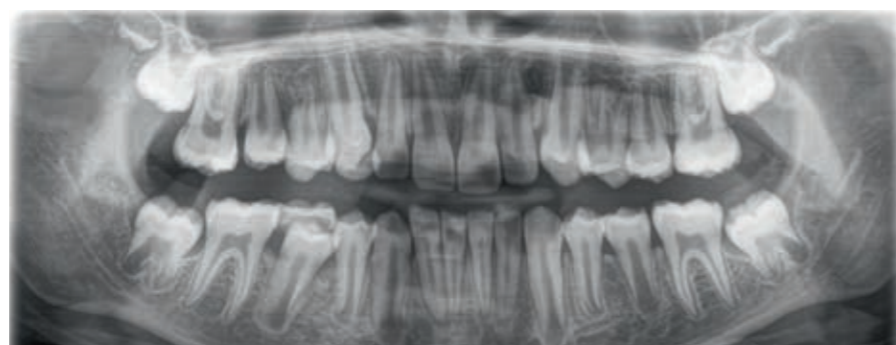

QuickScan function

The QuickScan function allows faster exposure cycles at a low radiation dose. This makes it easier to take panoramic and cephalometric images of children, for example.

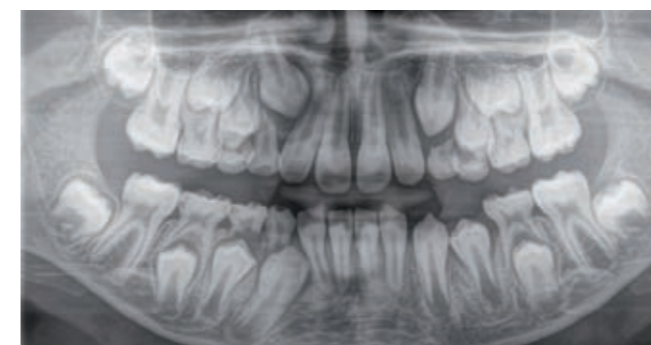

Lower dose thanks to framing

Use the framing function to select the region of interest if only a specific area of the volume is required for diagnosis. The advantage is that you can work at a lower dose.

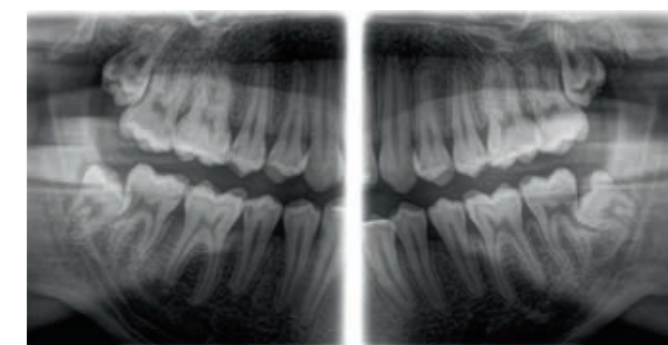

DCS - Sharpness down to the smallest detail.

Experience the future of panoramic imaging with the Direct Conversion Sensor (DCS)*. X-rays are converted directly to electrical signals – in contrast to conventional systems there is no signal loss due to light conversion. Your advantage: Incomparable definition even at very low dose.

* Only with Orthophos SL.

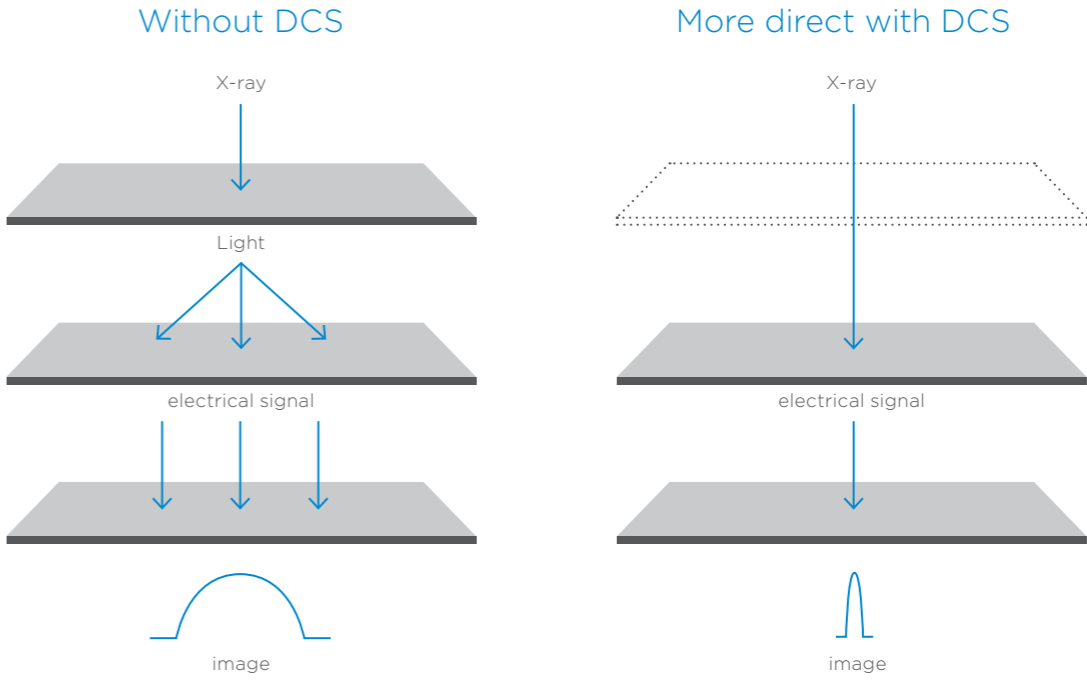

dentsplysirona.com/dcs-technology
Learn more about our DCS technology on our website

Better images, more accurate findings

The sharp layer technology automatically adapts the panoramic curve to the patient's individual anatomical features, ensuring that the entire jaw is always in the sharp layer. Manual pre-selection of the dental arch and tooth anomalies is eliminated. Special cases such as displaced teeth are no problem because you can define an image detail of your choice to focus in on lingual/buccal objects after scanning thanks to Interactive SL - for determining position without corrective scans.



Reliable diagnoses even in the most difficult cases

Thanks to Interactive SL, you can easily focus in on the required palatal / buccal objects without corrective scans even in special cases such as the hidden tooth root at the top of the image.



Smart solution

Dynamic images that you can adjust to the situation.

Experience you can rely on

Around the world, over 100,000 extraoral imaging units from Dentsply Sirona have been installed in practices. They impress their users with their high German quality standards, proverbial reliability in use, and ease of operation. Reliable after-sales support and topical product training provide additional peace of mind.

Dentsply Sirona is a pioneer in the field of imaging. We have been establishing new methods for 120 years – but only when they really do provide a simpler solution to challenges and allow you to work faster, more safely and more economically – and all to the benefit of the patients. The ideas that our 200+ developers are pursuing are becoming products, on which you can absolutely rely in everyday practice thanks to our extensive experience. You notice it when you work with a Dentsply Sirona 3D x-ray unit. The workmanship is first-class – even Made in Germany. If you choose Dentsply Sirona, you choose a solution built on viable, sustainable products that represent a first-class technological solution not only today, but in the future time and again.



„Made in Germany“ quality and future viability:

At the Center of Innovation in Bensheim, Germany, Dentsply Sirona products are developed for the highest demands.

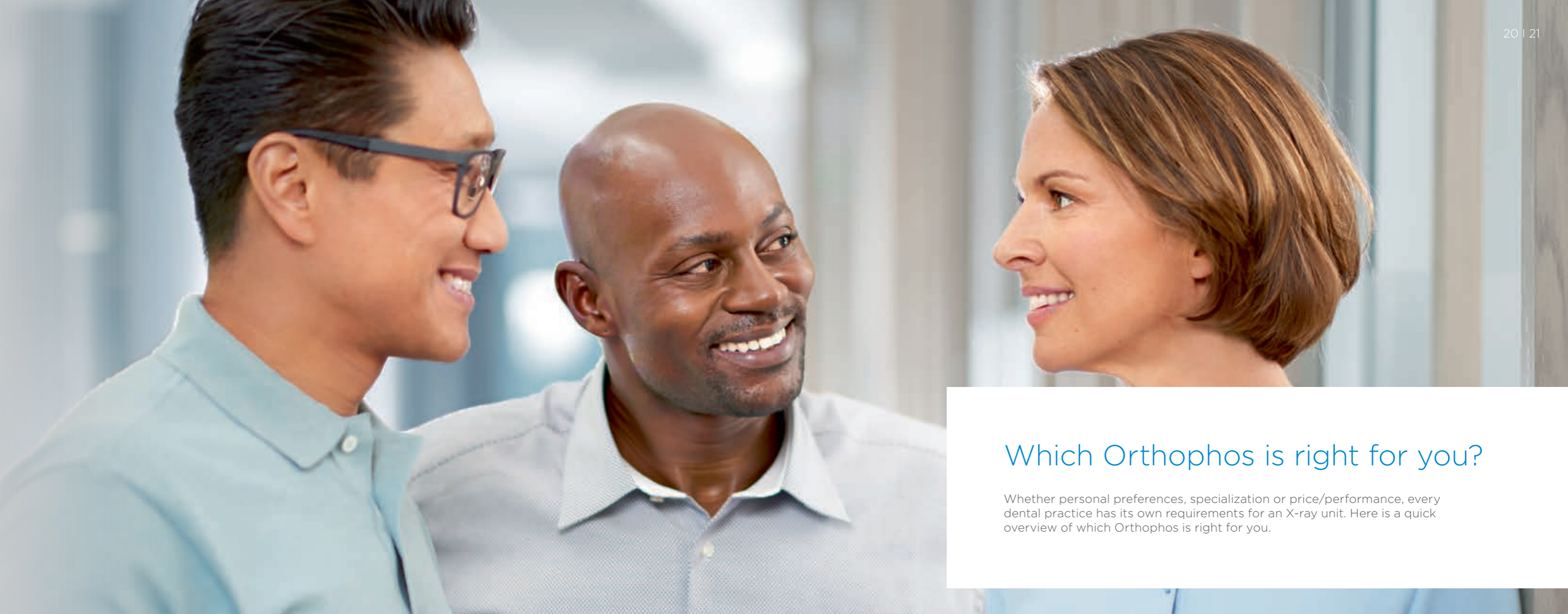

Which Orthophos is right for you?

Whether personal preferences, specialization or price/performance, every dental practice has its own requirements for an X-ray unit. Here is a quick overview of which Orthophos is right for you.

Overview of units

Orthophos SL 2D	The Orthophos SL 2D offers the highest image quality for demanding diagnoses with the lowest dose. The unit can be equipped with an optional cephalometric arm and a 3D module to grow with your practice.
Orthophos XG 3D ready	The Orthophos XG 3D ready is the ideal partner for dentists and group practices looking for a unit that can be easily upgraded to 3D for possible future applications.
Orthophos XG 5	With temporomandibular joint, sinus, bite wing and pediatric panoramic programs, Orthophos XG 5 makes a number of diagnoses possible. A cephalometric arm can be ordered optionally for modern orthodontics.
Orthophos XG 3	A practice-oriented, high-quality and reliable solution for entry into digital x-rays – and that with an exceptional value for money.

Which unit is the one for you?

Unit	Orthophos XG 3	Orthophos XG 5	Orthophos XG 3D ready	Orthophos SL 2D
Target group	General dentistry	General dentistry, orthodontics	General dentistry, orthodontics, specialist dentistry	General dentistry, orthodontics, specialist dentistry
Ceph retrofit options	-	■ Optional ceph arm left	■ Optional ceph arm right/left	■ Optional ceph arm right/left
3D retrofit options	-	-	■ Up to an FoV 8 cm x 8 cm	■ Up to an FoV 11 cm x 10 cm
2D technology	Lanex (optional CSI)	Lanex (optional CSI)	CsI	DCS

■ Available

Versatility has many fans

The Orthophos product range has the ideal unit for every practice. Every user finds the right functions and workflow options within the variety of units that make their individual work processes even more efficient.



Orthophos SL – the perfect partner for the orthodontic practice.

Dr. Hanna Ritter, Orthodontics, Hennef



Fit for now – fit for the future.

Dr. Magdalena Kyriasi-Schmalenberg, Orthodontics, Sinsheim



There is no going back from digital.

Dr. Dr. Peter Gebhardt, Oral and Maxillofacial Surgery, Heppenheim



The perfect 2D unit for entering the digital world of x-rays.

Dr. med. dent. Paul Rau, MSc, Edenkoben

„The entire team is excited about the Orthophos SL 2D. Patient positioning is simple, program selection intuitive and displayed images make diagnosis easier. Cephalometric images, for example, contain outstanding accuracy of detail, contrast and sharpness and are perfectly suited for orthodontic analyses and tracings.“

„My Orthophos XG 3D ready brings me into a new dimension of diagnostics due to its outstanding image reproduction. And you can even upgrade the unit for future challenges!“

„The program variety of the Orthophos XG5 offers numerous advantages. Whether a cephalometric and panoramic program or even sinus and bite wing images, together with the digital tools, new and better diagnostic options are made available.“

„Digitalizing my imaging process was definitely the right decision and I have the right partner on my side with the Orthophos XG3. As equipped, the Orthophos provides me with the perfect unit for everyday use.“



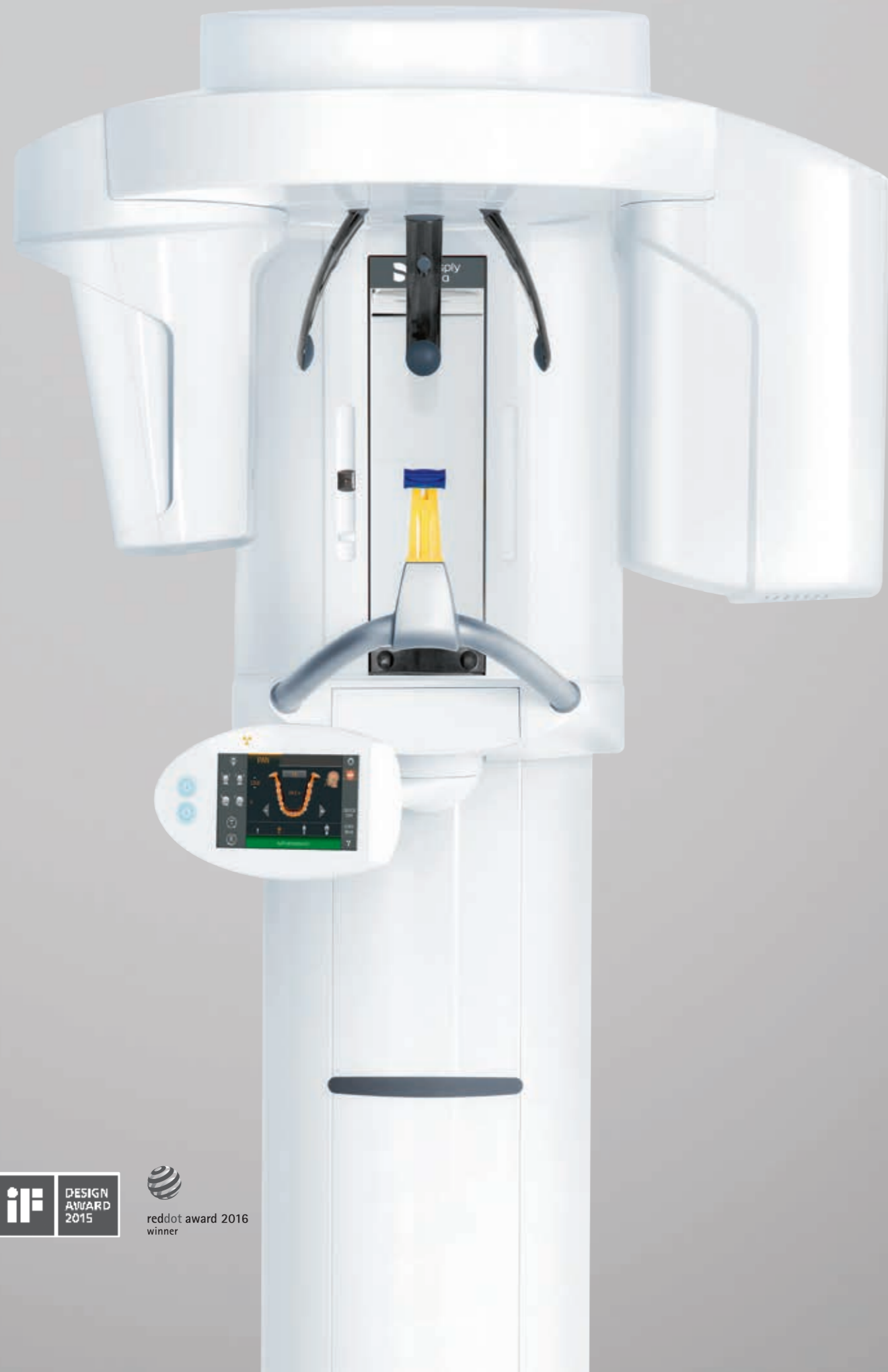

Orthophos SL 2D

For a user-friendly, optimum workflow, the Orthophos SL 2D combines revolutionary image quality with incomparable patented positioning aids.

The Orthophos SL is the latest member of the successful Sirona 2D x-ray family. It wins points for functionality, quality and design. With the DCS sensor you have the most innovative sensor technology at your disposal, delivering to you high resolution images with a unique level of sharpness. Thanks to the SL technology, you not only reliably get images in the sharp layer, but can respond interactively within the image to special cases (lingually/buccally) - without additional imaging. This is how the Orthophos SL 2D even satisfies the wishes of those dentists who have the greatest demands regarding panoramic imaging and is a symbol of incomparable definition in every image, in combination with the stable positioning from the 3-point head fixation, stable handles and patented occlusal bite block.

Investment security is ensured: Orthophos SL 2D can be equipped with a ceph arm or upgraded to 3D with a

volume of up to 11 cm x 10 cm. The ceph arm can be mounted on the left or right side of the unit and provides detailed, highcontrast cephalometric images perfectly suited for orthodontic analyses and tracings. Patients appreciate the soothing Ambient Light, which offers a choice of over 30 colors for a pleasant atmosphere in your X-ray room that fits perfectly into the look of your practice.

In combination with the pioneering Sidexis 4 software, the Orthophos SL also offers a unique variety of innovative solutions for the practice workflow.



DCS for incomparable image quality



Sharp Layer technologie



3D upgradable to up to 11 x 10 cm



Orthophos XG 3D ready

Orthophos XG 3D ready makes the ideal partner for dentists and group practices that wish to actively plan and shape their futures. With a range of programs, this unit offers you all diagnostic options. The intuitive EasyPad control panel and automatic patient positioning with the occlusal bite block ensure an efficient workflow.



Automatic positioning

It's now easier than ever to position the patient - the patented occlusal bite block automatically indicates on the EasyPad when the patient is in the correct plane. Together with the light localizers and 3-point head fixation, unnecessary corrective images are avoided.



Convenient operation

Your practice team can quickly and easily recognize the functions required on the EasyPad. A preview image appears directly after scanning. Additionally, the remote also indicates the chosen settings again before exposure.

Just a small step to 3D: With Orthophos XG 3D ready, the range of services can be expanded with a 3D module at any time. The benefit: additional investment security and confidence for you, just in case you i.e. want to offer implantology in your practice at a later stage.

Orthophos XG 5

Wide variety for perfect results: With additional programs, the Orthophos XG 5 offers more diagnostic options. The optional cephal arm makes all important views available to orthodontists. In addition to the usual cephalometric programs for lateral, symmetric and carpus images, a variety of special projections are possible, such as the Clementschitsch exposures.

Simple operation and variable features

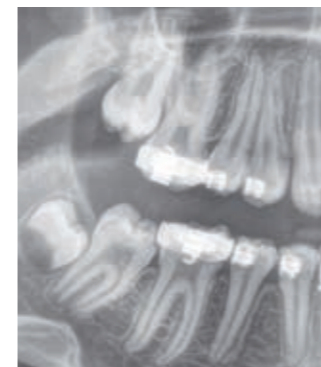

Choice of image quality with ASTRA



Choice of image quality without ASTRA

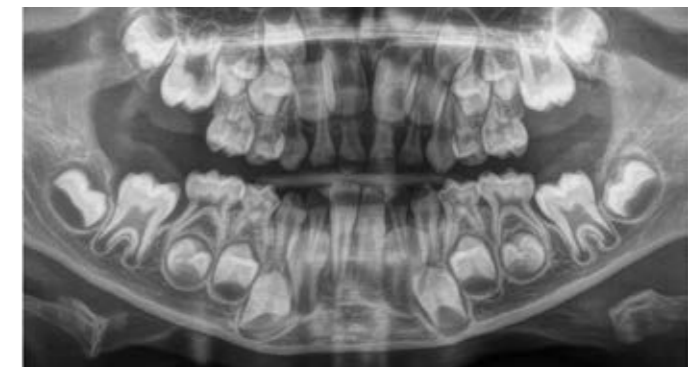

Pediatric panorama

More clarity in the images - thanks to ASTRA

No black borders around metal fillings, no excessive contrast. Thanks to CSI and ASTRA, you achieve images that impress by their specific clarity, thus ensuring fast and reliable diagnosis.

Pediatric panorama

The horizontally and vertically reduced pediatric panoramic program offers outstanding image quality with the lowest dose. Ideal for practices which treat a lot of children.



Orthophos XG 3

The horizontally and vertically reduced pediatric panoramic program offers outstanding image quality with the lowest dose. Ideal for practices which treat a lot of children. The unit's easy operation and seamless integration into your practice's daily routines will save you valuable time. The high image quality and proven Sidexis software guarantee that you will come to a safe diagnosis quickly and easily.

High-quality. Durable. Safe.

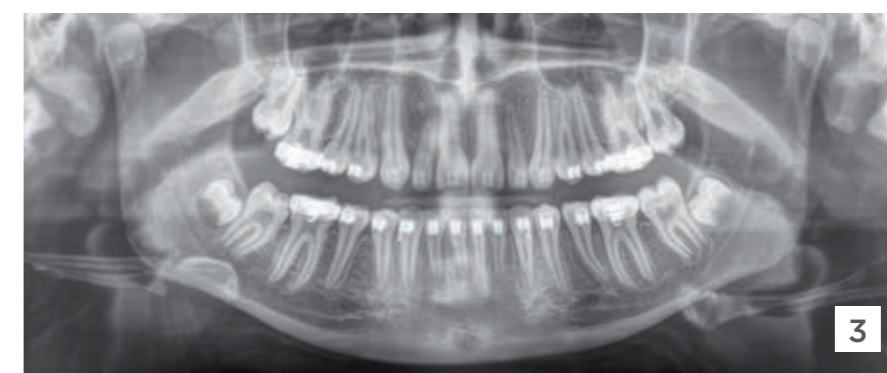

Well equipped for everyday practice life: You can reproduce the positioning very easily, since image parameters such as the bite block height are saved together with the image data. There is a bite wing program that helps in special cases and patient situations where intraoral images cannot be used and a shorter panoramic program with reduced dose that is suitable for treating children, for example.

- 1 Easy to operate**
Operation of the MultiPad is intuitive. Exposure parameters, for example, are selected via a patient symbol.
- 3 Very good image quality**
Thanks to ASTRA, an image quality for quick and reliable diagnoses is ensured even with the standard sensor.

- 2 Reliable positioning**
Only two light localizers are required for ideal positioning in the sharp slice. The motorized forehead and temple supports fixate the patient's head and prevent motion blurring.

More than images – real solutions

More solutions for your practice with X-rays from Sirona.

The Sidexis 4*, with its intuitive user interface and display of all kinds of images on a monitor – whether intraoral, 2D panoramic, or 3D – increases the efficiency of your practice and the accuracy of your diagnoses like no other software. But Sirona does not stop with the diagnosis – our solutions allow you to plan treatment for a number of different conditions and customize treatment for the individual patient. The processes remain in your practice and your patients appreciate your modern, understandable treatment methods. For satisfied patients and reliable work in your practice.

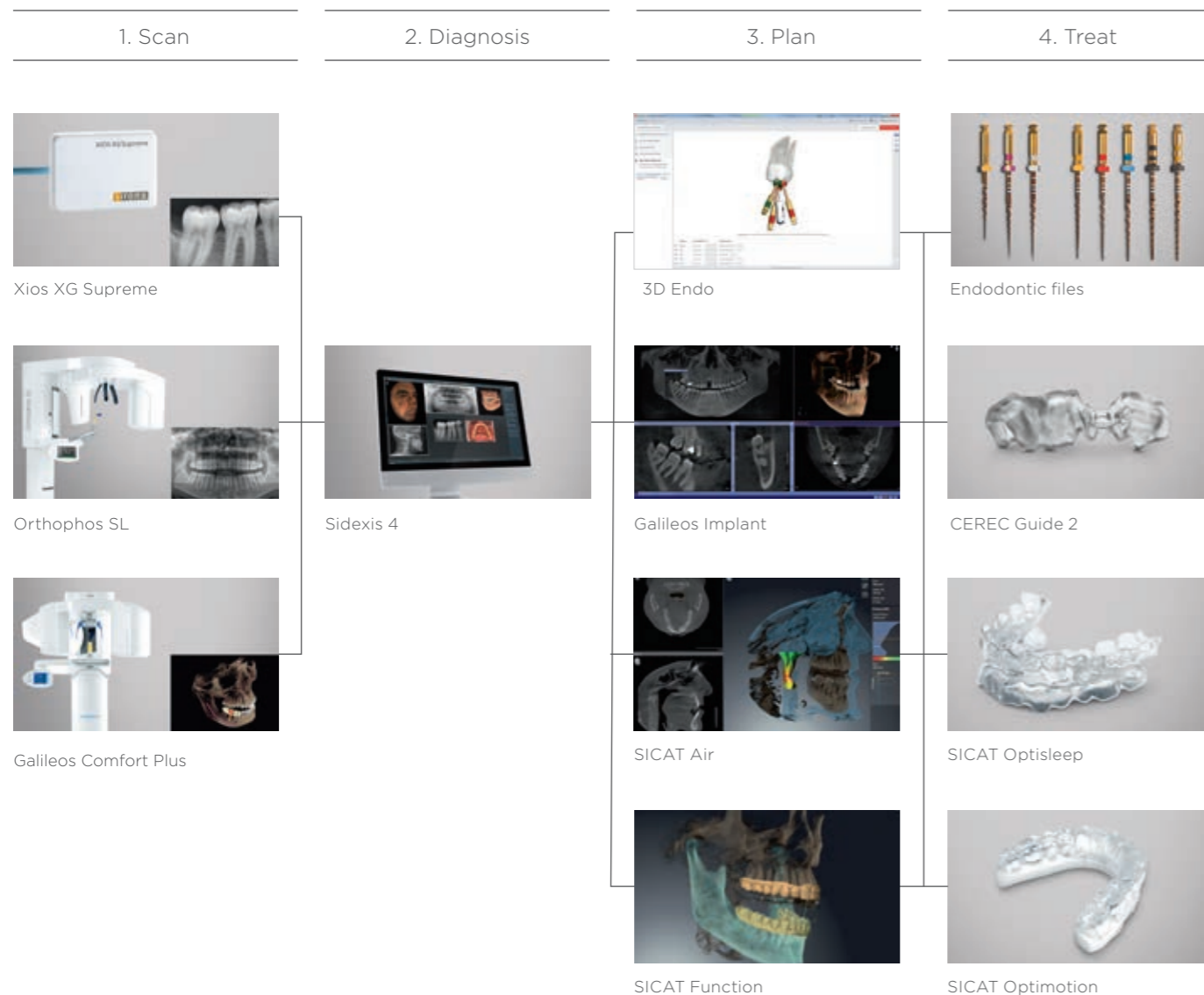

Technical properties

	Orthophos XG 3	Orthophos XG 5	Orthophos XG 3D ready	Orthophos SL 2D
Technical data				
User interface	MultiPad	MultiPad	EasyPad	EasyPad
5-year guarantee (2D/3D) on tubes and sensors	<input type="checkbox"/>	<input type="checkbox"/>	<input type="checkbox"/>	<input type="checkbox"/>
Ceph arm (18 cm x 23 cm and 30 cm x 23 cm)	-	<input type="checkbox"/> Left	<input type="checkbox"/> Left or right	<input type="checkbox"/> Left or right
Ceph unit with 2 sensors	-	<input type="checkbox"/>	<input type="checkbox"/>	<input checked="" type="checkbox"/>
Quickshot	-	-	<input checked="" type="checkbox"/>	<input checked="" type="checkbox"/>
Selectable anterior jaw shape	-	-	<input checked="" type="checkbox"/>	automatic
Anomaly compensation	-	-	<input checked="" type="checkbox"/>	automatic
Automatic detection of jaw width	-	<input checked="" type="checkbox"/>	<input checked="" type="checkbox"/>	<input checked="" type="checkbox"/>
Retrofit options	-	Ceph left	Ceph left/right/3D 8 cm x 8 cm	Ceph left/right/3D up to 11 cm x 10 cm
Automatic patient positioning: Occlusal bite block	-	-	<input checked="" type="checkbox"/>	<input checked="" type="checkbox"/>
X-ray generator	60-90 kV, 3-16 mA	60-90 kV, 3-16 mA	60-90 kV, 3-16 mA	60-90 kV, 3-16 mA
Panoramic exposure time	P1 Standard 14 s max	P1 Standard 14 s max	P1 Standard 14,2 s max, P1 Quickshot 9,1 s max	P1 Standard 14,2 s max, P1 Quickshot 9,1 s max
Radiation time Ceph 18 cm x 23 cm	-	9,4 s Standard	9,4 s Standard/ 4,7 s Quickshot	9,4 s Standard/ 4,7 s Quickshot
Patient positioning	Standing/seated	Standing/seated	Standing/seated	Standing/seated
Door width	At least 66 cm for installation	At least 66 cm for installation	At least 66 cm for installation	At least 66 cm for installation
Weight	Approx. 110 kg	Approx. 110 kg	Approx. 110 kg	Approx. 110 kg
Floor stand	<input type="checkbox"/>	<input type="checkbox"/>	<input type="checkbox"/>	<input type="checkbox"/>
Wheelchair accessible	<input checked="" type="checkbox"/>	<input checked="" type="checkbox"/>	<input checked="" type="checkbox"/>	<input checked="" type="checkbox"/>
Remote control	<input type="checkbox"/>	<input type="checkbox"/>	<input type="checkbox"/>	<input type="checkbox"/>
Csl sensor	<input type="checkbox"/>	<input checked="" type="checkbox"/>	<input checked="" type="checkbox"/>	Ceph

■ Available □ Optional

Product measurements

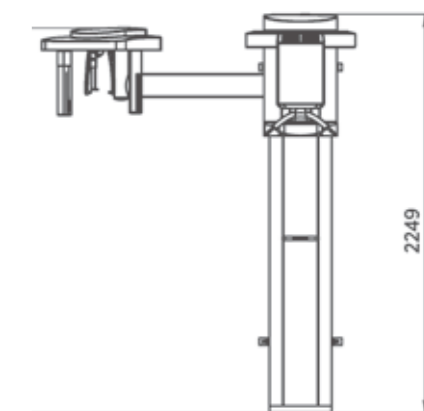
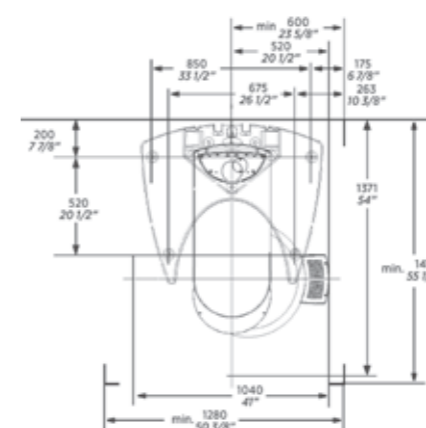
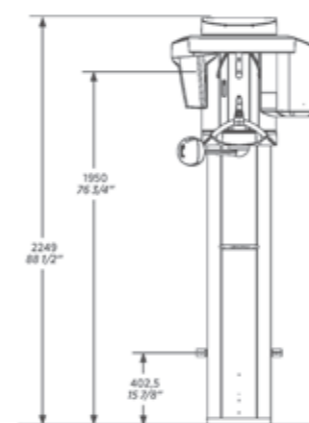

Space requirements min. 1,280 mm x 1,411 mm

With ceph arm min. 2,155 mm x 1,411 mm

*For more information about system requirements: sirona.com/SIDEXIS4-system_requirements

Programs at a glance

This overview lists all programs and the associated scans of the Orthophos XG 3D ready. Please refer to the technical properties table for details of which of these programs are also available with the Orthophos SL 2D, Orthophos XG 5 and Orthophos XG 3. The ORTHOPHOS XG 3 also exclusively offers the bite wing program BW10 and the shorter panoramic scan P20.

Programs	Orthophos XG 3	Orthophos XG 5	Orthophos XG 3D ready	Orthophos SL 2D
Standard panoramic image	P1, P20	P1, P10	P1, P2, P10	P1, P2, P10
Image detail of left or right-hand side	P1L, P1R	P1L, P1R	P1, P1A, P1C P2, P2A, P2C P10, P10A, P10C BW1	P1, P1A, P1C P2, P2A, P2C P10, P10A, P10C BW1
Image detail of individual quadrants	-	-	P1, P1A, P1C P2, P2A, P2C P10, P10A, P10C	P1, P1A, P1C P2, P2A, P2C P10, P10A, P10C
Image detail of upper or lower jaw	-	-	P1, P1A, P1C P2, P2A, P2C P10, P10A, P10C, P12	P1, P1A, P1C P2, P2A, P2C P10, P10A, P10C, P12
Constant magnification	P1C	P1C	P1C, P2C, P10C	P1C, P2C, P10C
Artifact-reduced	P1A	P1A	P1A, P2A, P10A, TM1A.1, TM1A.2, TM2A.1, TM2A.2	P1A, P2A, P10A, TM1A.1, TM1A.2, TM2A.1, TM2A.2
Thick-layer images of anterior region	-	P12	P12	P12
Sinus images	-	S1	S1, S2, S3, S4	S1, S3
Multi-layer images of premolars	-	MS1	MS1	-
Temporomandibular joint	TM1.1, TM1.2	TM1.1, TM1.2	TM1-TM6	TM1.1, TM1.2, TM3
Bite wing exposure	BW10	BW1	BW1, BW2	BW1, BW2
Ceph (optional)	-	C1, C2, C3, C3F, C4	C1, C2, C3, C3F, C4	C1, C2, C3, C3F, C4

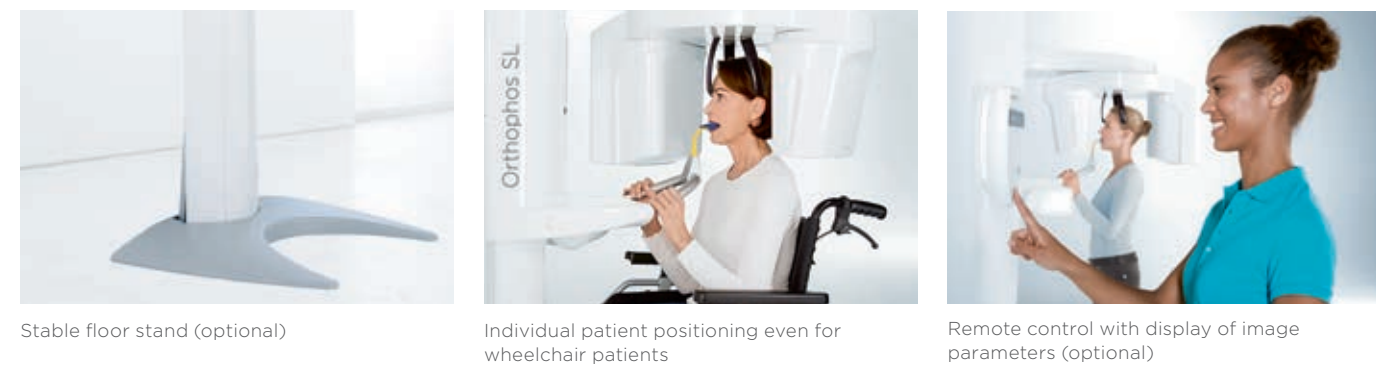

Panorama

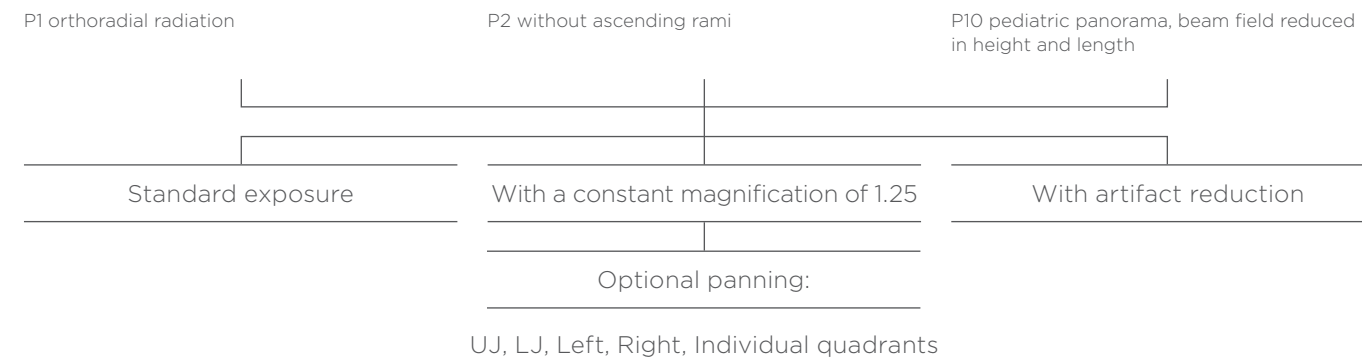

P12 thick slice in anterior tooth region

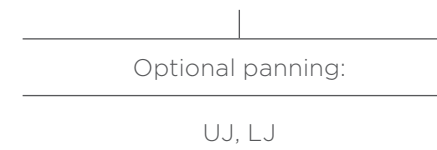

Bitewing

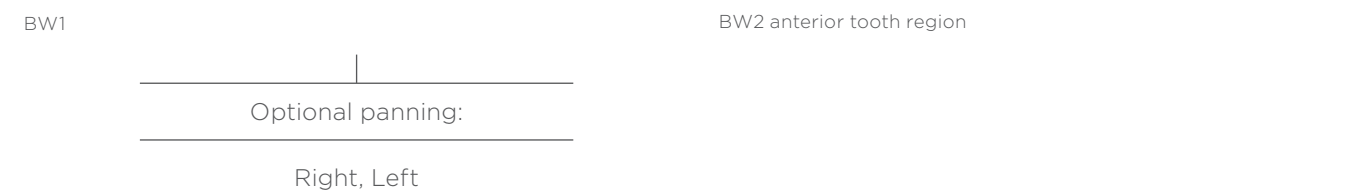

TMJ

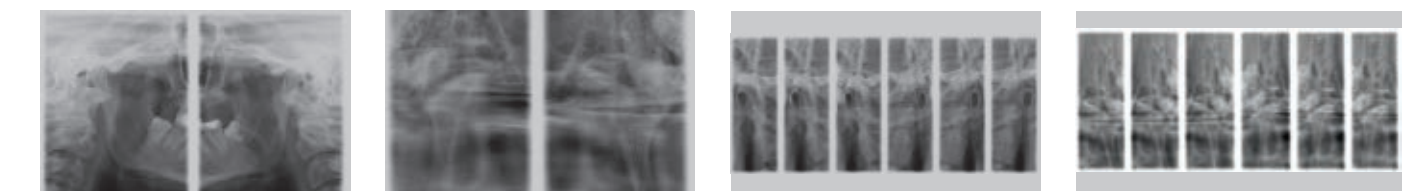
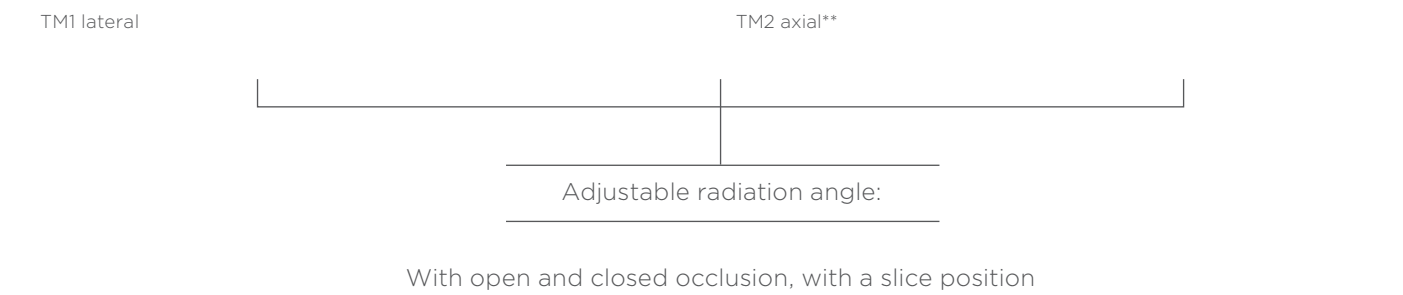
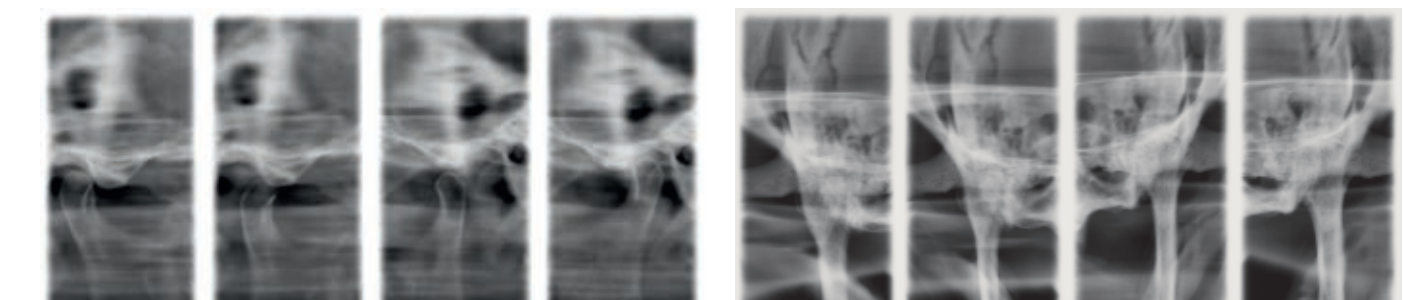

TM3, TM4**, TM5**, TM6**

Sinus

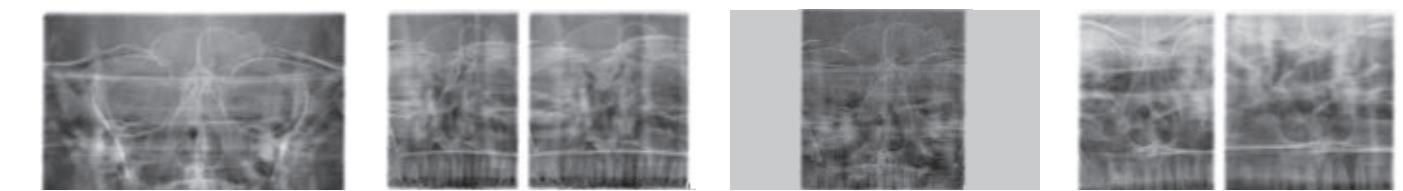

S1 jaw cavities, S2 jaw cavities twice**, S3 simple jaw cavities linear, S4 jaw cavities twice linear**

Multislice in posterior tooth region

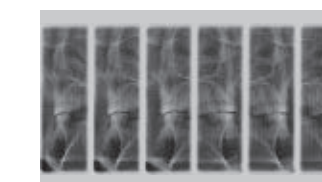

MS 1**

This overview shows all 2D programs and the related images of the ORTHOPHOS XG 3D. Differences from the Orthophos SL 3D are marked accordingly.

** Image not available with the Orthophos SL 3D

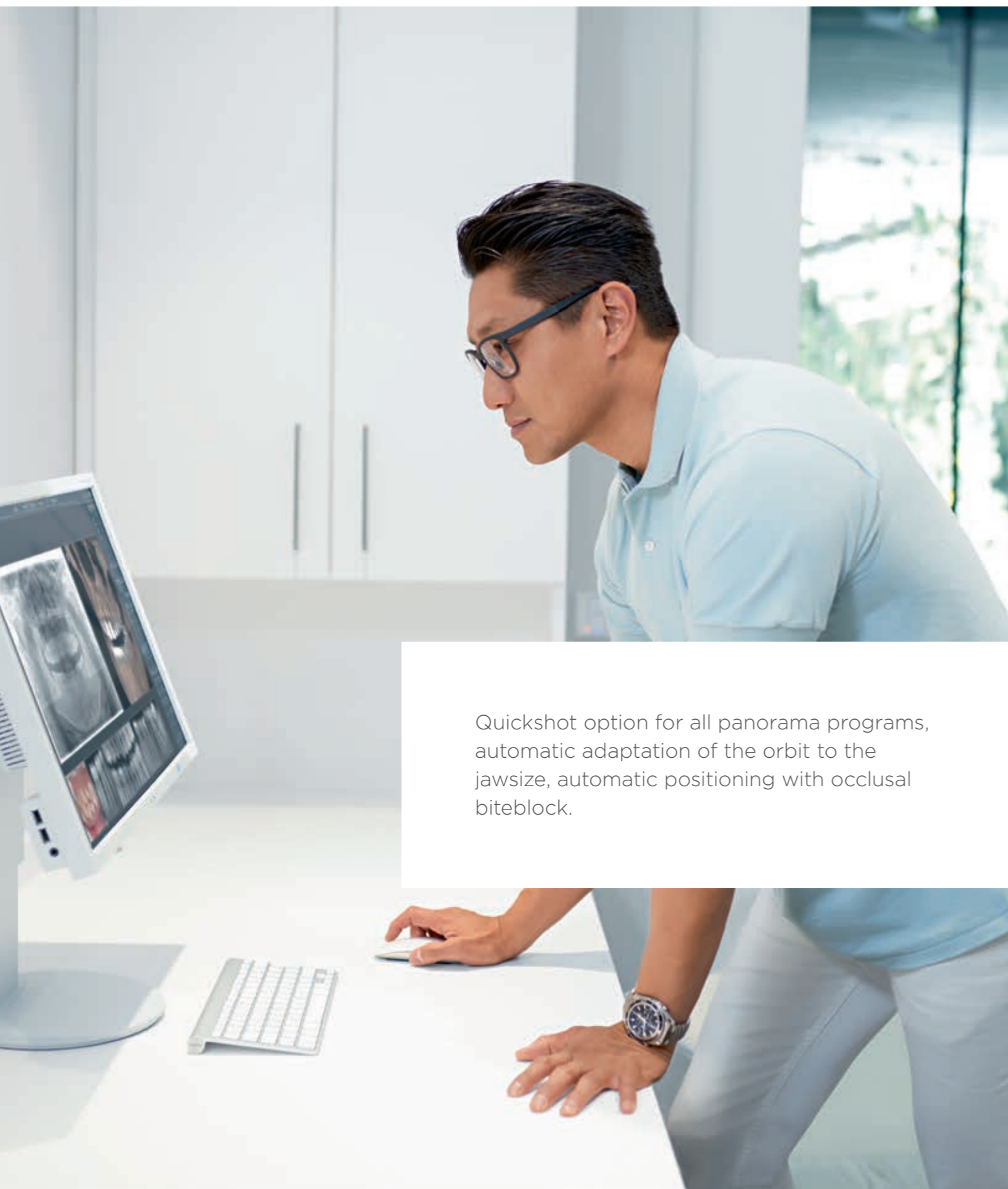

Quickshot option for all panorama programs, automatic adaptation of the orbit to the jawsize, automatic positioning with occlusal biteblock.

Dentsply Sirona

Sirona Dental Systems GmbH
Fabrikstraße 31, 64625 Bensheim, Germany
dentsplysirona.com

THE DENTAL
SOLUTIONS
COMPANY™

Procedural Solutions

Preventive
Restorative
Orthodontics
Endodontics
Implants
Prosthetics

Enabling Technologies

CAD/CAM
Imaging
Treatment Centers
Instruments

