

Right

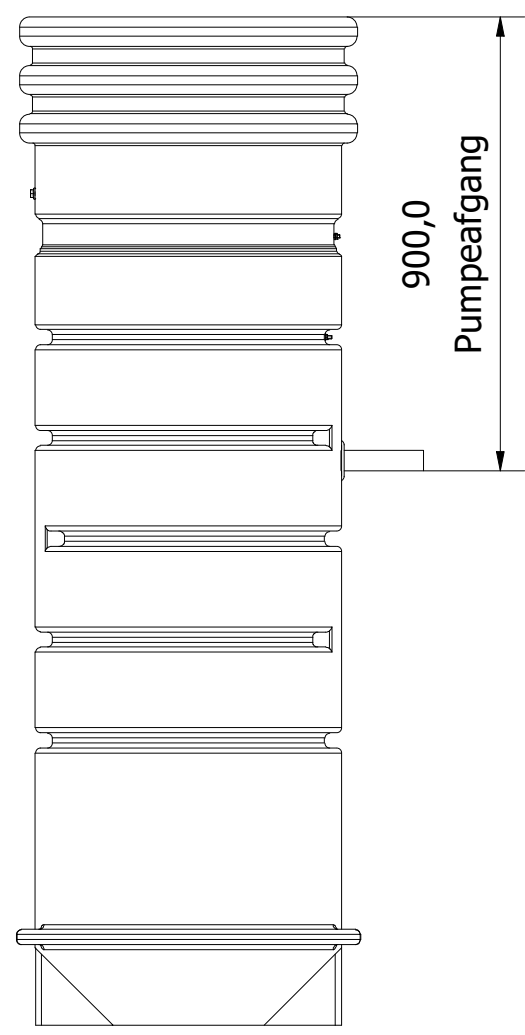

Front

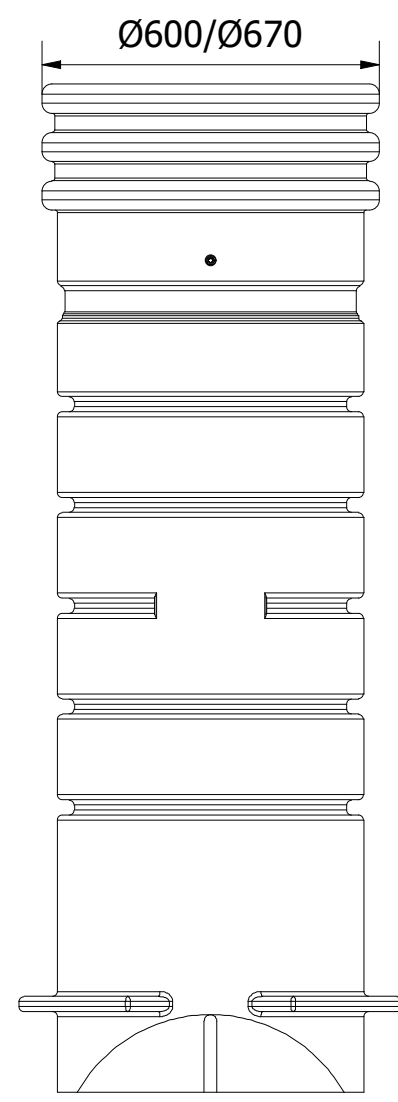

Left

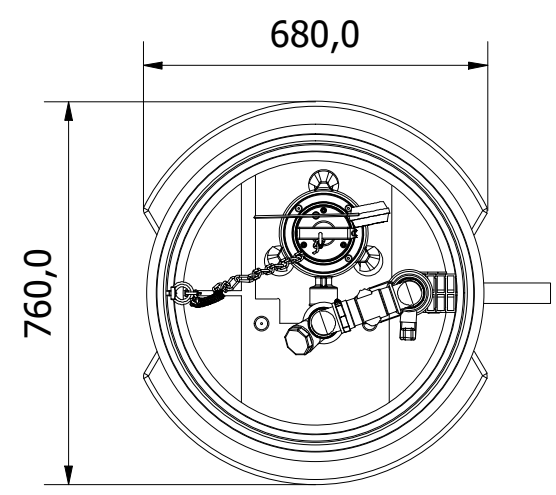

Top



Denne tegning må ikke kopieres, forevises andre firmaer og personer eller anvendes på en måde, som strider mod WaterCare's interesser.

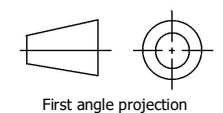

First angle projection

Tlf. Watercare (DK):  
+45 70 25 65 37

Varenummer / Projekt  
223190605-82

Info  
Alle mål i mm ± 3% afvigelse

Ark  
1 / 1



Titel  
Ø600 Pumpebrønd

Størrelsesforhold  
1:15

Volumen / kapacitet  
2000 mm

Dato  
22-04-2024

Format  
A3